

The KEB logo consists of the letters 'KEB' in a bold, white, sans-serif font, set against a dark red rectangular background. To the right of this rectangle is another solid dark red rectangle of the same height.

KEB

CONTROL AND AUTOMATION

CONTROL AND AUTOMATION

V 2.2 EN

**WELCOME
TO THE
WORLD OF
AUTOMATION**



CONTENT

KEB

The Company	4
Solution	8
Control System	10

SOFTWARE PLATFORM

COMBIVIS studio 6	12
COMBIVIS studio 6 - Safety	38
COMBIVIS CONTROL Runtime	46
COMBIVIS CONTROL Library	64
COMBIVIS studio HMI	86
COMBIVIS connect	108
COMBIVIS cloud	120

TECHNICAL SOLUTIONS

CNC	122
Extruder	138

PRODUCTS

Product Overview	144
Embedded Technology	145
C6 HMI	148
C6 HMI LC	154
C6 S14	160
C6 SMART	166
C6 COMPACT	172
H6 CONTROL	178
C6 SAFETY PLC	184
C6 ROUTER / C6 CLOUD ROUTER	190
IPC Technology	200
C6 E22	202
C6 P33	216
C6 P34	222
Industry monitors	236
C6 MONITOR	238
C6 AMM - Arm Mounting Monitor	244
EtherCAT® Fieldbus I/O	250
C6 REMOTE I/O	254

The KEB logo is displayed in white, bold, sans-serif capital letters on a red rectangular background. The background of the entire page is a blurred photograph of an industrial setting, showing a green printed circuit board (PCB) with two blue electrolytic capacitors in the foreground. The capacitors are labeled with '470µF 25V' and '105°C'. In the background, there are various industrial components, including a large black cylindrical component and some yellow and blue parts, all out of focus.

AUTOMATION WITH DRIVE

Drive means movement - controlled movement requires overview and technology - the complete system provides the correct basis for high-performance, economics and efficiency.

KEB – A SUCCESS STORY

KEB - three letters. Initials. An initial start in 1972. Karl-Ernst Brinkmann began his success story with six employees. Constantly growing, today KEB is a medium-sized company employing with nearly 1500 people. And we have remained owner-managed for two generations - a detail which makes us proud.

Structured growth for over 45 years and strong ties to the region and economic area of Ostwestfalen-Lippe (OWL): reliability creates confidence, especially in our role as an employer. Long service records impressively document close connections to the company, our suppliers, partners and customers.

KEB develops mechanical and electronic solutions for modern drive and automation systems. The current product portfolio, including a wide range of control systems, results from the continuous refinement of technical innovations to reflect the needs and practical experiences of our customers.

Today, KEB has branches and production plants at strategic locations throughout Europe, North America and Asia, all connected with centralised data management, and identical engineering and design programs for the development of hardware and software.

That is not the end of the story but only the beginning! We are well positioned for the future.

KEB's broad orientation to the various sectors of mechanical engineering and plant construction gives us an accurate insight into the needs and trends of the market. In the past, this was based mainly on drive solutions but today KEB is an important global manufacturer of a wide product range.

In addition, we have set ourselves the target of supplementing the portfolio for automation with powerful systems solutions. Development is based on recognised technical standards, the core element of IPC technology with rapid Ethernet communication via EtherCAT®. We draw our stimulus and requirements for future-oriented, universal concepts and solutions from direct contact with customers.

Today, creative engineers and technicians develop powerful software and hardware, optimally prepared for the system and connected in a powerful engineering tool.

Complex automation technologies require reliable partnerships. KEB has the skills to find common, ideal solutions which achieve maximum flexibility and economic efficiency. Our main focus is on meeting your needs, from custom one-time custom projects to serial production

Our team of specialists are available to help.

CONTROL & AUTOMATION

Flexible and economic automation solutions allow maximum use of technological developments in wide areas of application.

VISUALISATION, PLC, MOTION CONTROL, CNC, REMOTE MAINTENANCE

The KEB range offers extensive hardware solutions in combination with excellent software functionalities, from display through to the motion profile.



KEB

KEB – SUCCESS FROM HISTORY

Foundation of KARL E. BRINKMANN GMBH

Development, production and sale of electro-magnetic clutches and brakes

1972

COMBIVERT 56

Production of our first generation of converters

1985

KEB SCHNEEBERG established

Expansion of product range by internal development and production of gear motors

1993

DRIVES

From frequency inverters to servo systems, dynamically connected in real-time communication or classic analog/digital. Universally designed for open and closed loop operation.

Optimum shaft performance for three-phase, synchronous, torque, linear or spindle motors.

DYNAMIC DRIVE CONTROLLER - SOFTWARE / HARDWARE IN THE SYSTEM

In single-axis or multi-axis technology. When required, also optimised as a customer or application device.



MOTORS & GEARS

Integral gear motors with flexible options - for three-phase asynchronous or synchronous servo motors.

OPTIMUM ADAPTATION OF ROTATION SPEED TO TORQUE - IN ALL INSTALLATION POSITIONS.

Modular system with a wide range of options for ideal adaptation of machine requirements in the form of spur gears, flat gears, worm spur gears, bevel spur gears and planet gears.



AUTOMOTIVE Sector

Electromagnetic switch clutches for automotive technology

COMBICONTROL C5

Development and production of controls and motion control

KEB DEVELOPS

into a supplier of complete automation solutions

Karl E. Brinkmann GmbH is

KEB Automation KG

2000

2005

2013

2017



KEB



- A success story for over 40 years
- Technology-driven company with huge investment in research and innovation
- Quality and durability are our passion
- Competence is our product
- Our solutions are based on standards
- Open and communicative thanks to many interfaces and fieldbus systems
- From touch to movement

SOLUTION

The perception of a change, Industry 4.0. With KEB's automation solution, you have the chance to be part of this change.

Our complete concept from the control level through to the drive technology offers standards, connectivity, communication and total flexibility thanks to the full openness of the solution. Despite our wide product range, our high level of integration and competence as a manufacturer in all levels of the automation world is impressive.

KEB offers both retention and freedom in the implementation of authorisation tasks. Support from people and intelligent functions created by people. Because intelligence is not only predicting the future, but reacting to it in advance.

This is supported by realtime designed control and Ethernet-based synchronous fieldbus systems in conjunction with dynamic drive engineering and impressive gear technology.

SOFTWARE

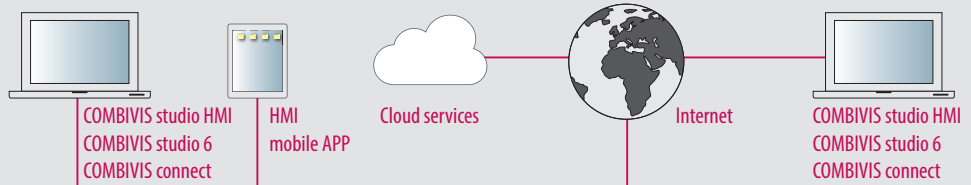

HMI

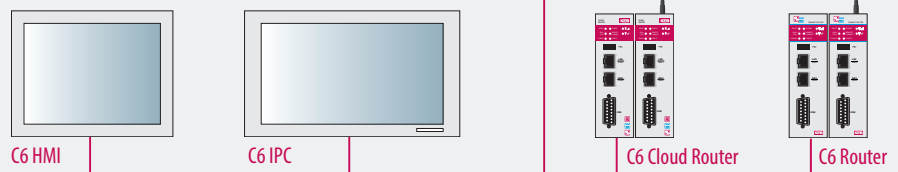

CONTROL

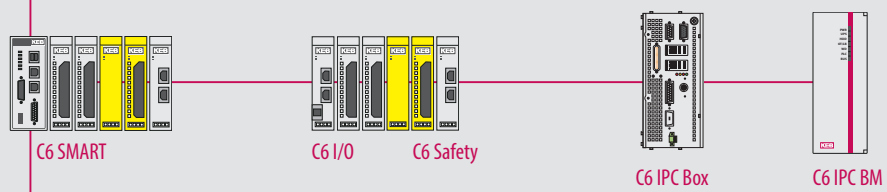

DRIVES

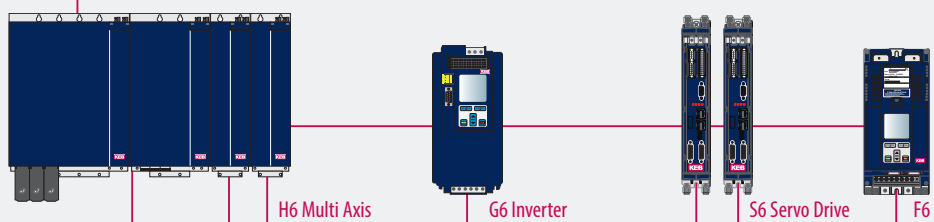

MOTORS

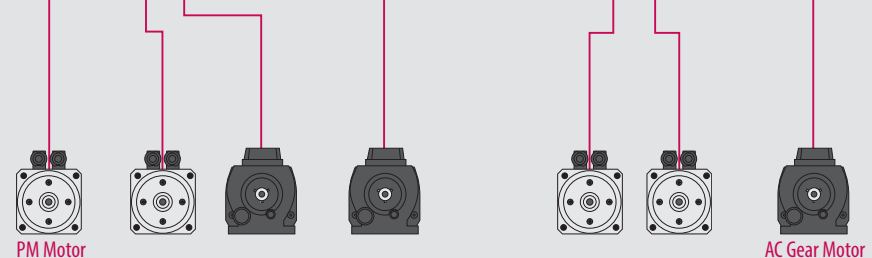

CONTROL SYSTEM



DISPLAY TYPE

Capacitive touch, resistive touch
4:3 Format: 5.7", 8.4", 10.4", 12.1", 15", 17" (5:4), 19" (5:4)
16:9 Format: 4.3", 7" (15:9), 10.1", 12.1" (16:10), 15.6", 18.5", 21.5", 24"

FORMAT

Panel
Box
Book Mount
DIN Rail
Arm Mount

PROTECTION CLASS

IP66
IP65
IP20

LICENSES

CE
cULus



EtherCAT®
CANopen®

SOFTWARE

Visualisation



Control / Motion



Remote maintenance



Cloud



HARDWARE ARCHITECTURE

SuperH RISC SH7269
ARM Cortex A8 - iMX5
ARM Cortex A9 - iMX6
Intel® Bay Trail - Celeron®
Intel® Skylake - Core i

OPERATING SYSTEM

Windows Embedded Compact 7
Windows Embedded Standard 7P

FIELDBUS SYSTEM

Master	Slave
EtherCAT®	EtherCAT®, CANopen
CANopen	Profibus, Profinet Powerlink, EtherNet/IP MODBUS, ...

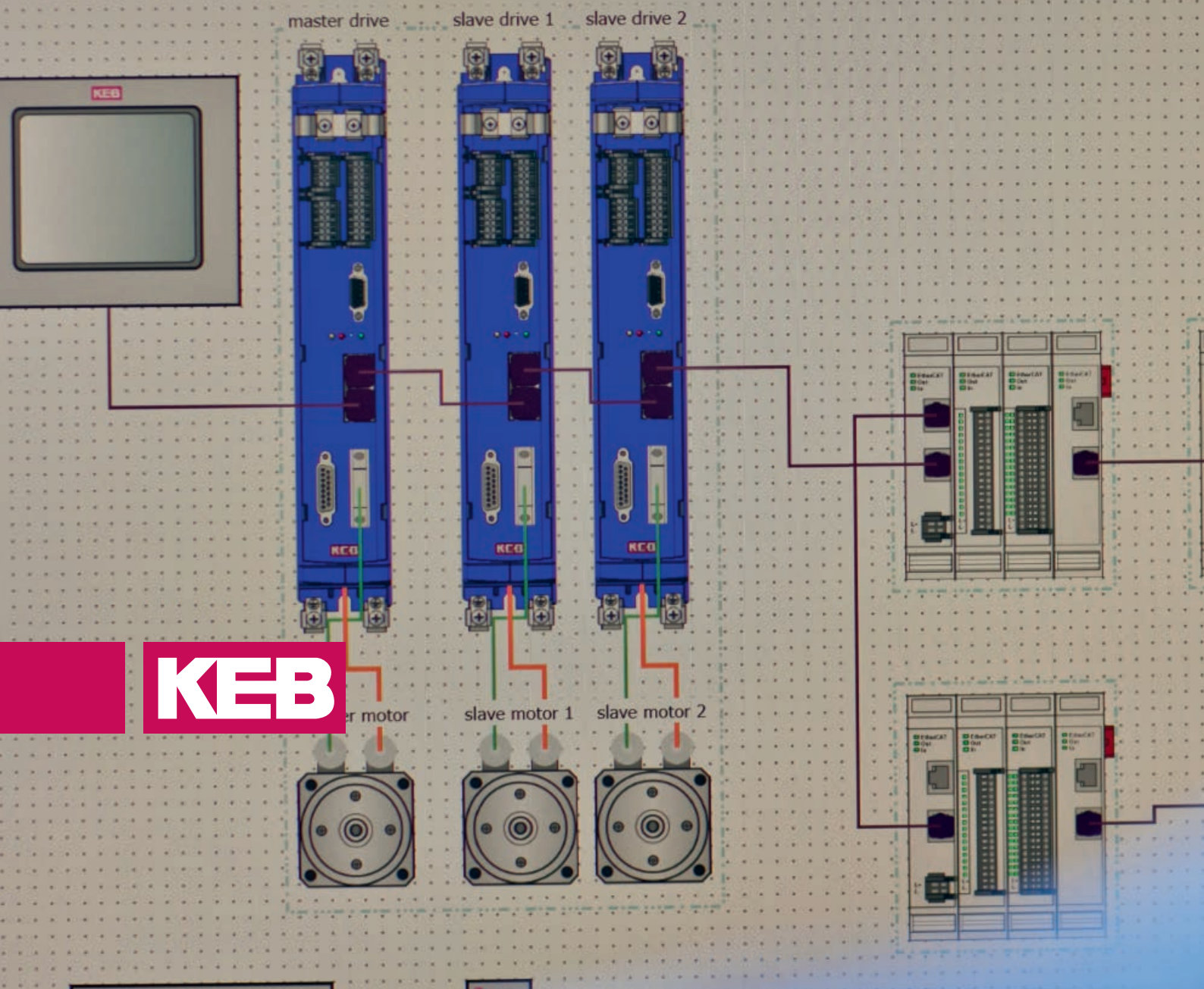



COMBIVIS studio 6 INTEGRATED DEVELOPMENT ENVIRONMENT

The intelligent automation suite from KEB combines an assistant-guided component selection, fieldbus configuration, drive parameterisation, IEC 61131-3 project generation and motion control.

Throughout the planning and layout phase, implementation of control sequences and multi-axis movement profiles, to start-up and fine tuning, the user is supported by a tool developed by experienced application engineers. With a foundation built on libraries, devices and template databases, rapid and simple solutions can be generated for a wide range of applications.

COMBIVIS STUDIO 6

FREELY CONFIGURABLE TOOLBAR

and system information

PROJECT ORGANISATION

and application planning

SYSTEM CONFIGURATION

FIELDBUS CONFIGURATION AND DIAGNOSIS

Drive parameterisation
Multi-channel oscilloscope

CROSS REFERENCE LIST

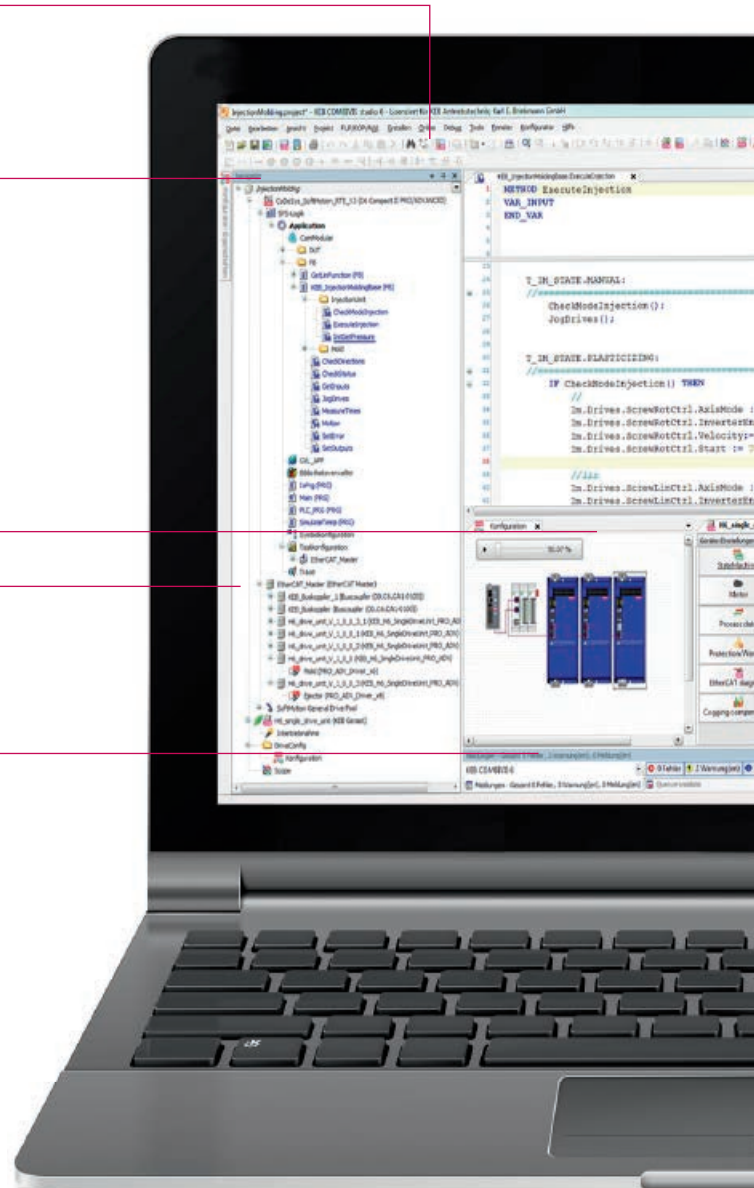

In KEB COMBIVIS Studio 6, IEC 61131-3 application development, drive parameterisation and HMI designers are combined into an efficient engineering tool for individual automation solutions.

The software allows easy access to programming to IEC 61131-3, and thus lays the foundations for independent and future-oriented source code with flexible choice of programming languages. Users benefit from comfortable "SmartCoding" with tools for declaration, error diagnosis, debugging and online data analysis.

Access to the KEB database also results in time-saving access to operating instructions, technical drawings and datasheets for project production and documentation.

With the KEB Utilities, we offer direct access to motion programming for real-time compatible, synchronized action drives or even multi-axis systems.

Integrated editors provide support for profile production in the sectors of cam discs, electronic gears, angle synchronization and the integration of G codes. KEB COMBIVIS studio 6 simplifies both simulation and visualisation of movement processes in the office environment, together with start-up and plant optimisation on-site.

Intuitive start-up assistants, digital 16-channel oscilloscope, tools for data backup and recovery, and extensive expert tweaks for optimised fine tuning of systems, complete the engineering software from the development of automation to after-sales service.

OBJECT-ORIENTED PROGRAMMING

STANDARD IEC LIBRARIES

APPLICATION LIBRARIES

COMMISSIONING ASSISTANTS

MESSAGE WINDOW

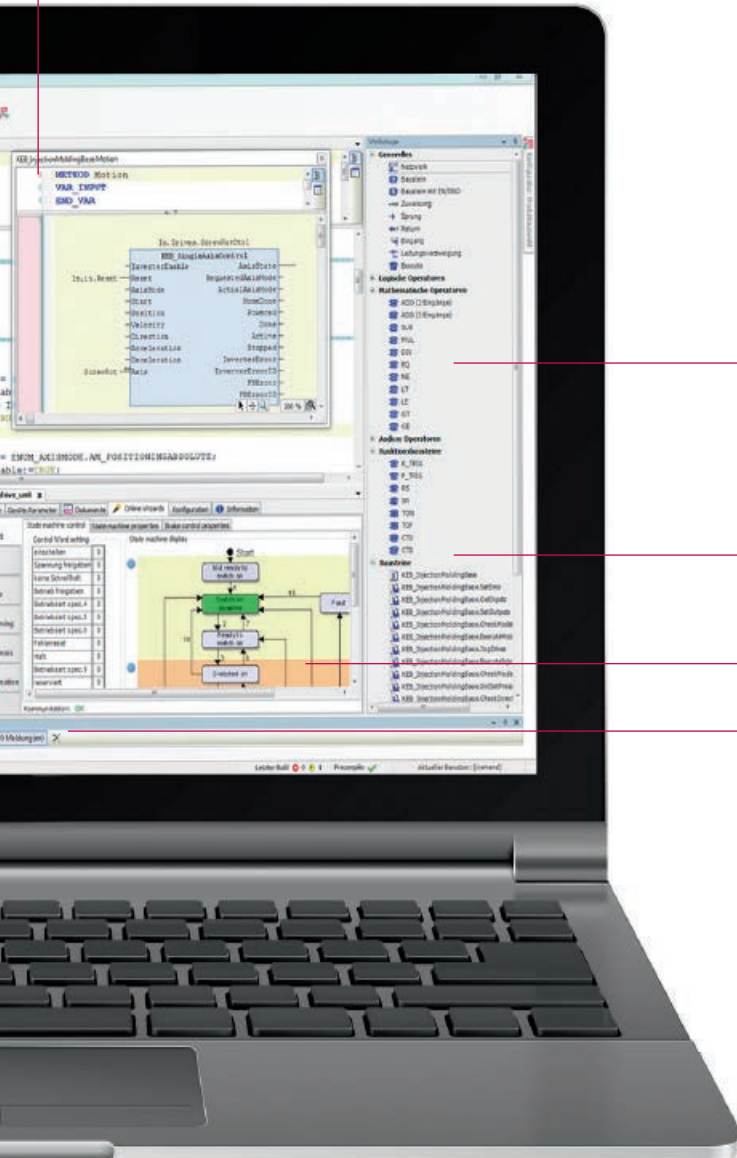

HIGHLIGHTS

- IEC 61131-3 application development
- Device and library database
- Product configuration
- Start-up and diagnosis assistant
- COMBIVIS studio HMI integration
- Document database

AUTOMATION WITH STANDARDS

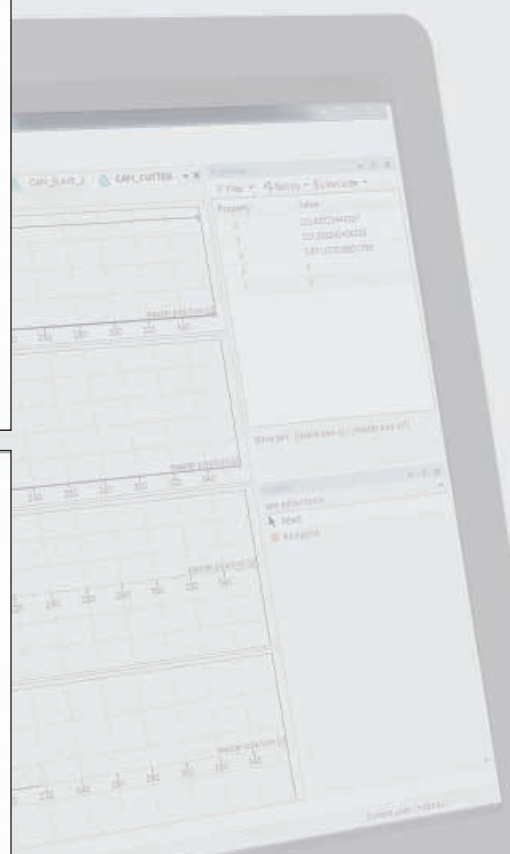
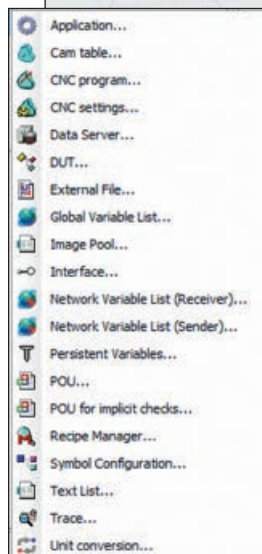
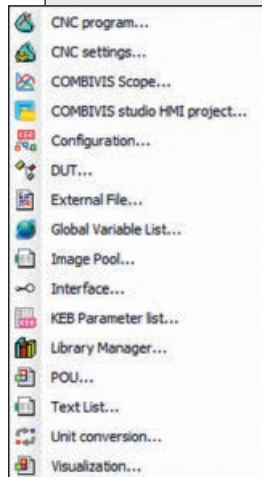
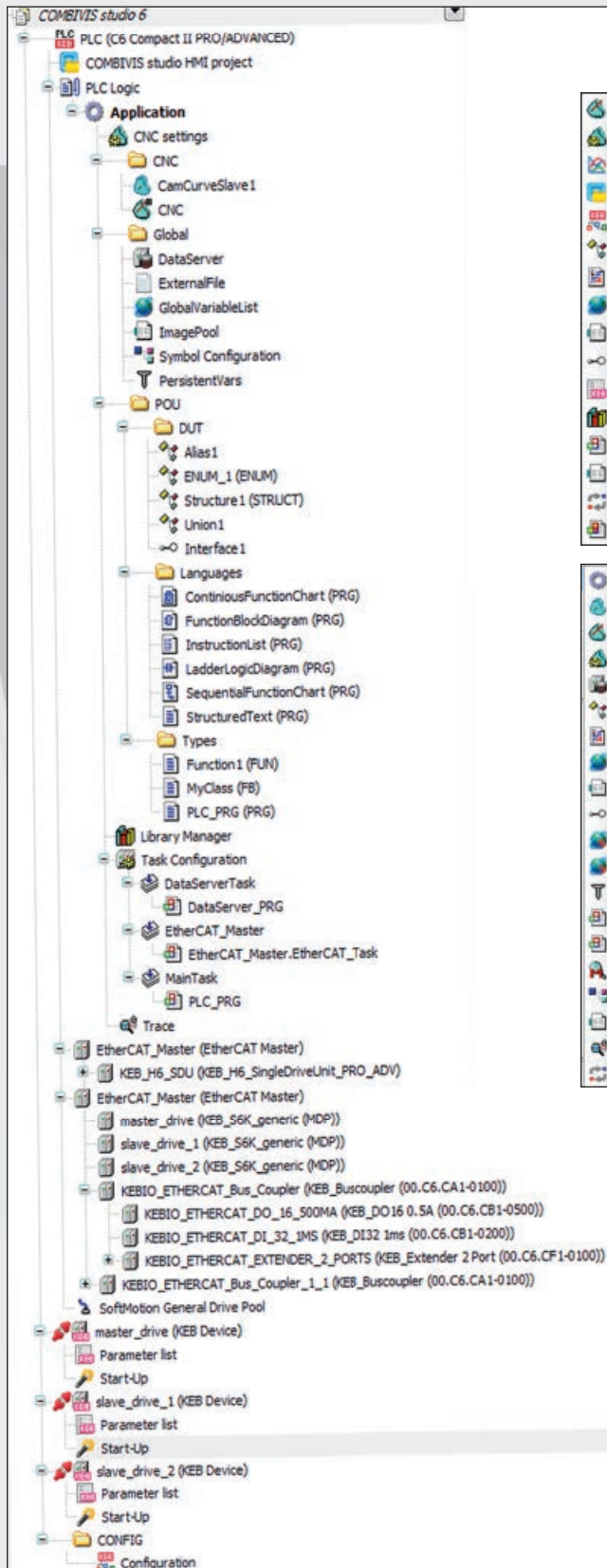

COMBIVIS studio 6 was developed so that even complex tasks could be programmed with ease. For example, simply right-clicking with the mouse adds objects, selects object properties and changes their settings. Using the software, users are able to work with standard development environments without further investment. These environments include the robust .NET framework.

Because KEB uses the same basic framework as Microsoft Visual Studio, worldwide language support, a standardised user interface, data access and Internet applications are already integrated. Working with the standardised languages of IEC 61131-3 clears the way for reusing previously developed code in future projects.

Because PLC Open Motion Control is used as the motion design standard, compatible devices which support clearly defined movement function blocks can be used. This continuity creates the basis for programming codes which are truly manufacturer-independent. The concept is flanked by faster engineering due to shorter integration and the reuse of already programmed codes.

Designed for industrial automation, COMBIVIS studio 6 offers everything users need for programming control systems - including know-how protection. Our software securely encrypts the project codes running on the devices so that no one can read the process knowledge behind them at a later date.

For efficient, time-saving engineering, again source code must be archived in a way which allows later processing to re-use the original library and compiler versions without time-consuming searching. For example, when, during future maintenance and upgrades, a technician needs direct access to the control system on site, the password-protected archive will be directly available in the device memory.

The platform applies a user-friendly project navigator for this work, which allows simple access to multiple devices and the definition of data exchange between these. Directories for organizing all objects, user-defined toolbars, keyboard shortcuts and standard Windows functions such as Search and Replace, are just some examples of this user-friendly development environment...



IEC 61131-3: AUTOMATION WITH STANDARDS

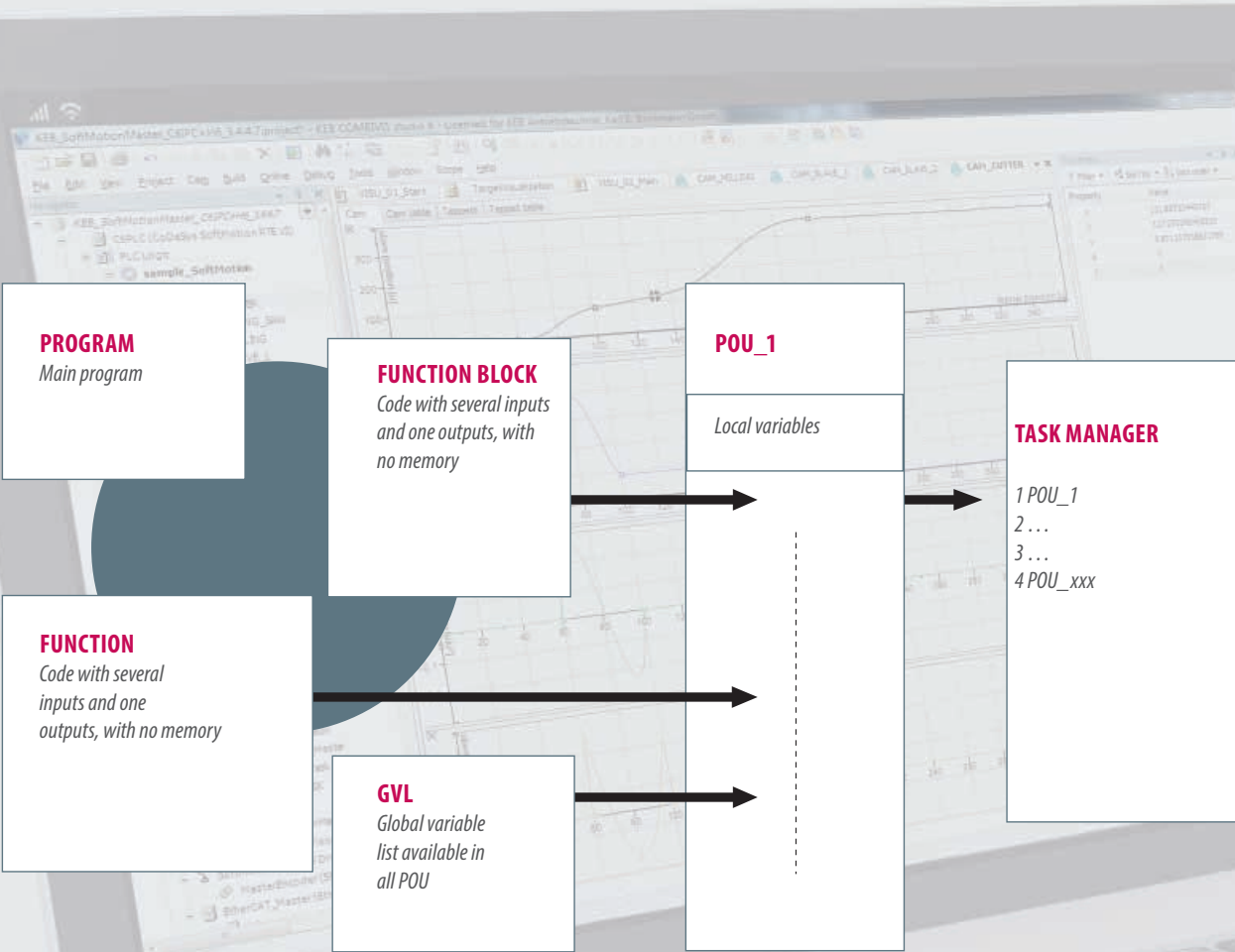

IEC 61131-3 EDITORS

The development level of COMBIVIS studio 6 offers flexible programming possibilities, complete on-line and off-line functions, compilers and components for configuration, visualisation and diagnosis. Thanks to user feedback, all editors are designed practically for simple and time-saving use. The KEB software uses the international standardised programming languages of IEC 61131-3 as a basis:

- Ladder Diagram (LD)
- Function Block Diagram (FBD)
- Instruction List (IL)
- Continuous Function Chart (CFC)
- Sequential Function Chart (SFC)
- Structured Text (ST).

In both on-line and off-line mode, the code can be switched between LD, FBD and IL at the press of a key - and is then converted automatically. Functions, actions and methods are supported and can be programmed in a different language from the higher-level program organisation unit (POE). Function blocks and commands can be accessed directly or via drag and drop from a toolbox.

In addition, COMBIVIS studio 6 offers intelligent input assistants, automatic fill-in functions and expanded IntelliSense functionality. Context-sensitive commands are available in development of the application by right-clicking with the mouse or by automatic production of language concepts. There are no POE limits within the platform - only the hardware resources set the limits.



HIGHLIGHTS

- The six most common programming languages worldwide
- Object-orientation at high language level
- Extensive toolboxes and standard libraries
- Modern Smartcoding functions

STRUCTURED TEXT (ST)

Thanks to the high-level language concept, Structured text (ST) of IEC 61131-3 is mainly recommended for programming loops, state machines and process sequences. If programmers are already familiar with languages such as "C", "PASCAL" and "BASIC", they quickly become familiar with ST because the editor offers functions already known from other high-level language tools.

For example, if an IF code block must be produced, the editor automatically adds the necessary END_ and includes the code place in the block, so that the next code line can be entered. If the programmer places the cursor on the IF keyword, the associated END_IF is automatically highlighted which makes programming of long nested conditions much easier. In addition, code blocks can be flipped open and closed by simply clicking on the "-" or "+" symbols on the left next to the initial instruction.

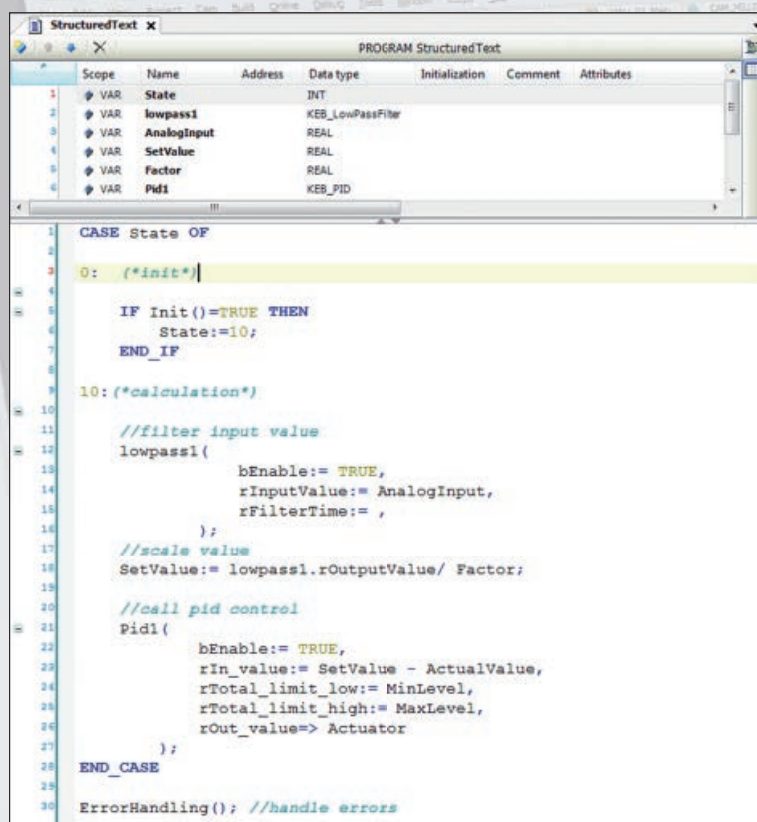

Scope	Name	Address	Data type	Initialization	Comment	Attributes
1	VAR State		INT			
2	VAR lowpass1		KEB_LowPassFilter			
3	VAR AnalogInput		REAL			
4	VAR SetValue		REAL			
5	VAR Factor		REAL			
6	VAR Pid1		KEB_PID			

```
1 CASE State OF
2
3 0: (*init*)
4
5   IF Init()=TRUE THEN
6     State:=10;
7   END_IF
8
9 10: (*calculation*)
10
11   //filter input value
12   lowpass1(
13     bEnable:= TRUE,
14     rInputValue:= AnalogInput,
15     rFilterTime:= ,
16   );
17   //scale value
18   SetValue:= lowpass1.rOutputValue/ Factor;
19
20   //call pid control
21   Pid1(
22     bEnable:= TRUE,
23     rIn_value:= SetValue - ActualValue,
24     rTotal_limit_low:= MinLevel,
25     rTotal_limit_high:= MaxLevel,
26     rOut_value=> Actuator
27   );
28 END_CASE
29
30 ErrorHandling(); //handle errors
```

Structured Text (ST)



HIGHLIGHTS

- Compact program code
- Programming of loops, state machines, process sequences
- All advantages of a modern high-level language

INSTRUCTION LIST (IL)

The Instruction list (IL) in IEC 61131-3 is one of the best-known programming languages because it has been used since the very beginning of automation. IL is a simple language based on an Accumulator-Load-Save model. In each process, first via the LD command, a value is loaded into the accumulator and then the desired process is retrieved.

This result is then written to the accumulator and can be stored in a variable via the ST command. The IL Editor supports all IEC 61131-3 operators, irrespective of whether the processes have one or more inputs and outputs. As in the other standard languages, commands, negations, jumps and set/reset commands are available.

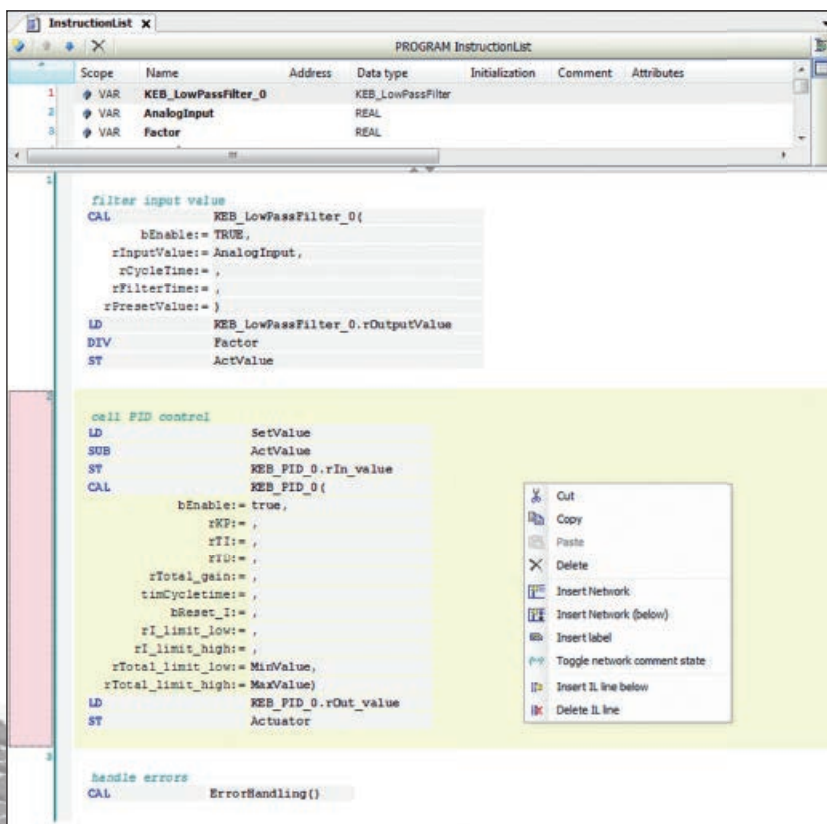

Instruction list (IL)



HIGHLIGHTS

- Machine-level assembler language
- Register commands and jumps
- Retrofit applications

FUNCTION BLOCK DIAGRAM (FBD)

The graphic editor of the Function block diagram language (FBD) is a combination of a step-like Ladder diagram and a compact function block diagram. If the user inserts a new element, the connecting lines are reated automatically. The FBD toolbox also allows programming by drag-and-drop.

Inputs can be defined or negated without additional function blocks for rising or falling edges. Outputs support set, reset and jump configurations. As in the LD editor, an activation input (IN/INO) can be added to the function block so that this is only executed if desired.

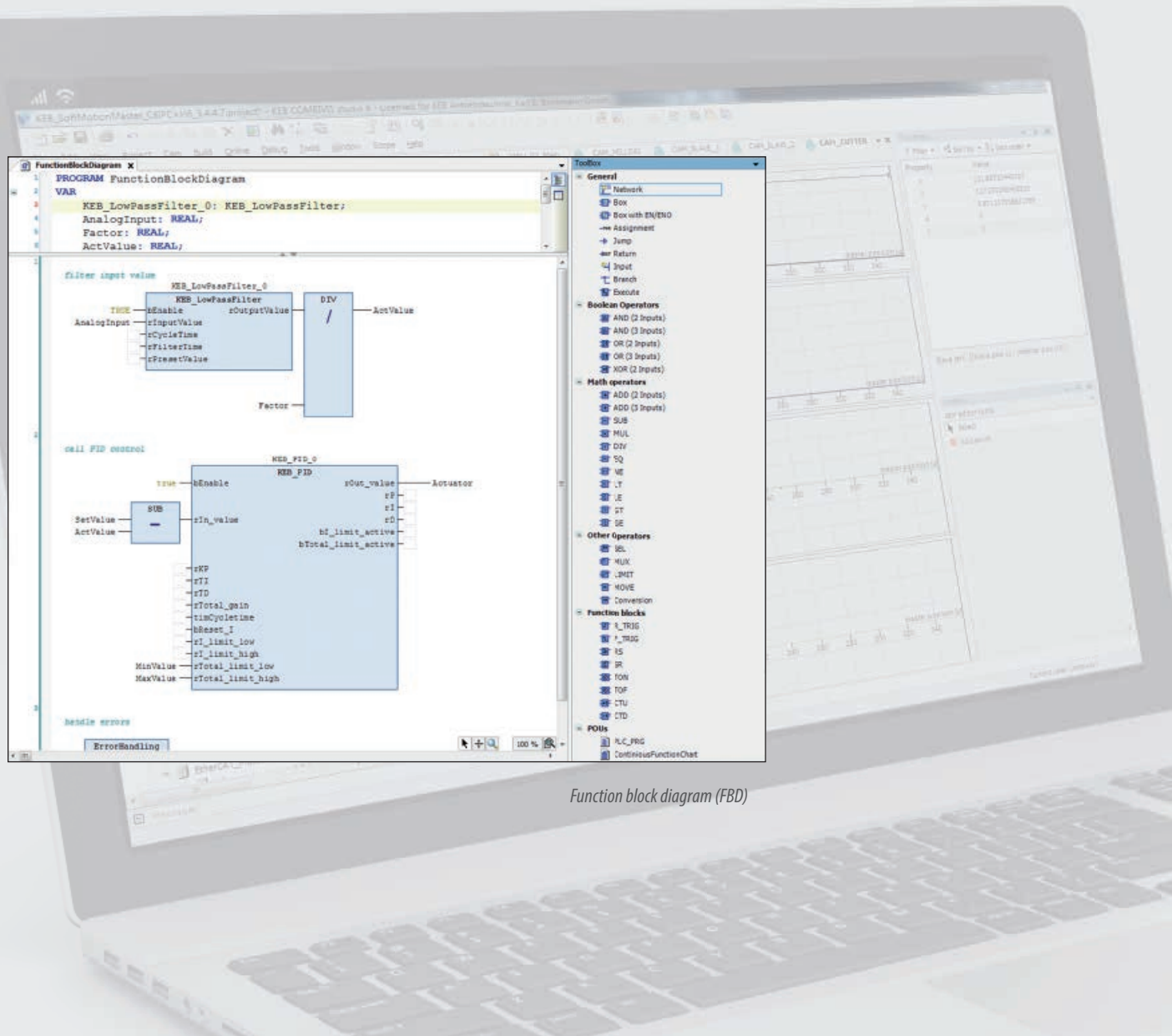

Function block diagram (FBD)



HIGHLIGHTS

- Programming by drag-and-drop
- Clear graphic design
- Compact function block depiction

LADDER DIAGRAM (LD)

Also known as contact logic or relay logic, Ladder diagram (LD) shows the code as electrical circuits. The easy-to-follow depiction of contacts and relays makes LD popular with control system programmers in particular. Boolean expressions are shown by the connection of relay contacts with coils from the “Power Rail” on the left to the “Common Rail” on the right.

A function-rich toolbox divided into Boolean, mathematical and logic operators, allows the programmer to use the KEB control system as a standard PLC - but with the performance ability of a programmable automation controller.

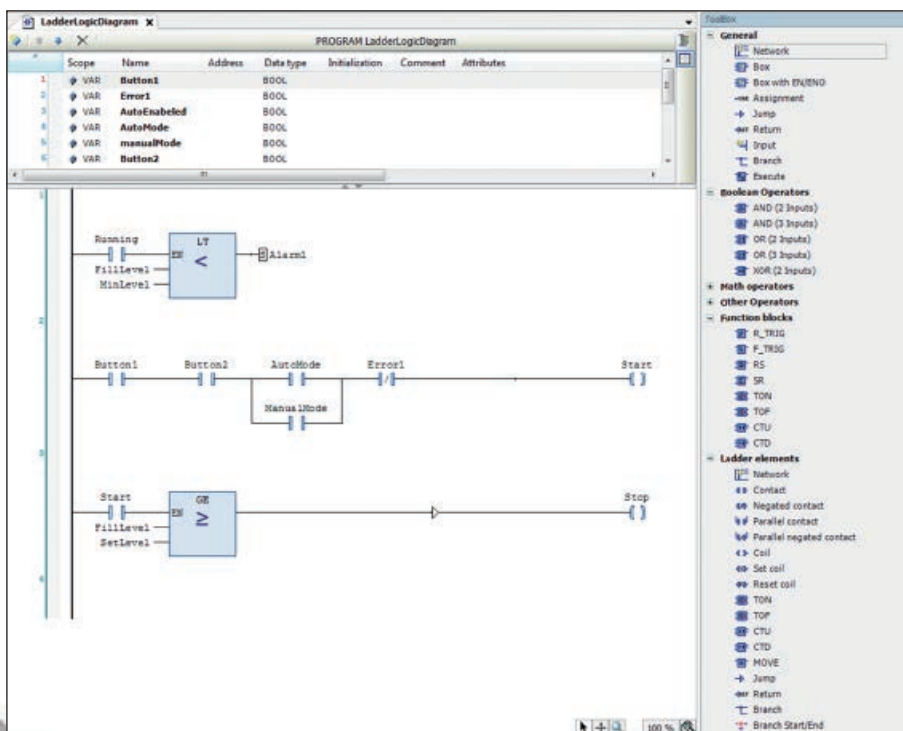

Ladder diagram (LD)



HIGHLIGHTS

- Graphic, network-oriented
- Boolean terminology and switch conditions
- Perfect for I/O handling

SEQUENTIAL FUNCTION CHART (SFC)

As a graphic language, Sequential function chart (SFC) in practice takes the form of a flow diagram. The tasks of a programming sequence are clearly broken down and shown as individual steps or blocks of program code. Defined actions are performed in the steps as long as the step is active within a program run-through.

Sequential function chart is used to define transitional conditions which must be resolved during the transition from one step to the next. Several steps can be performed in parallel or in alternative branches. The programming language can be selected independently between step and transition. KEB's SFC editor supports all instructions defined by the IEC standard for programming steps in sub-programs and transitions.

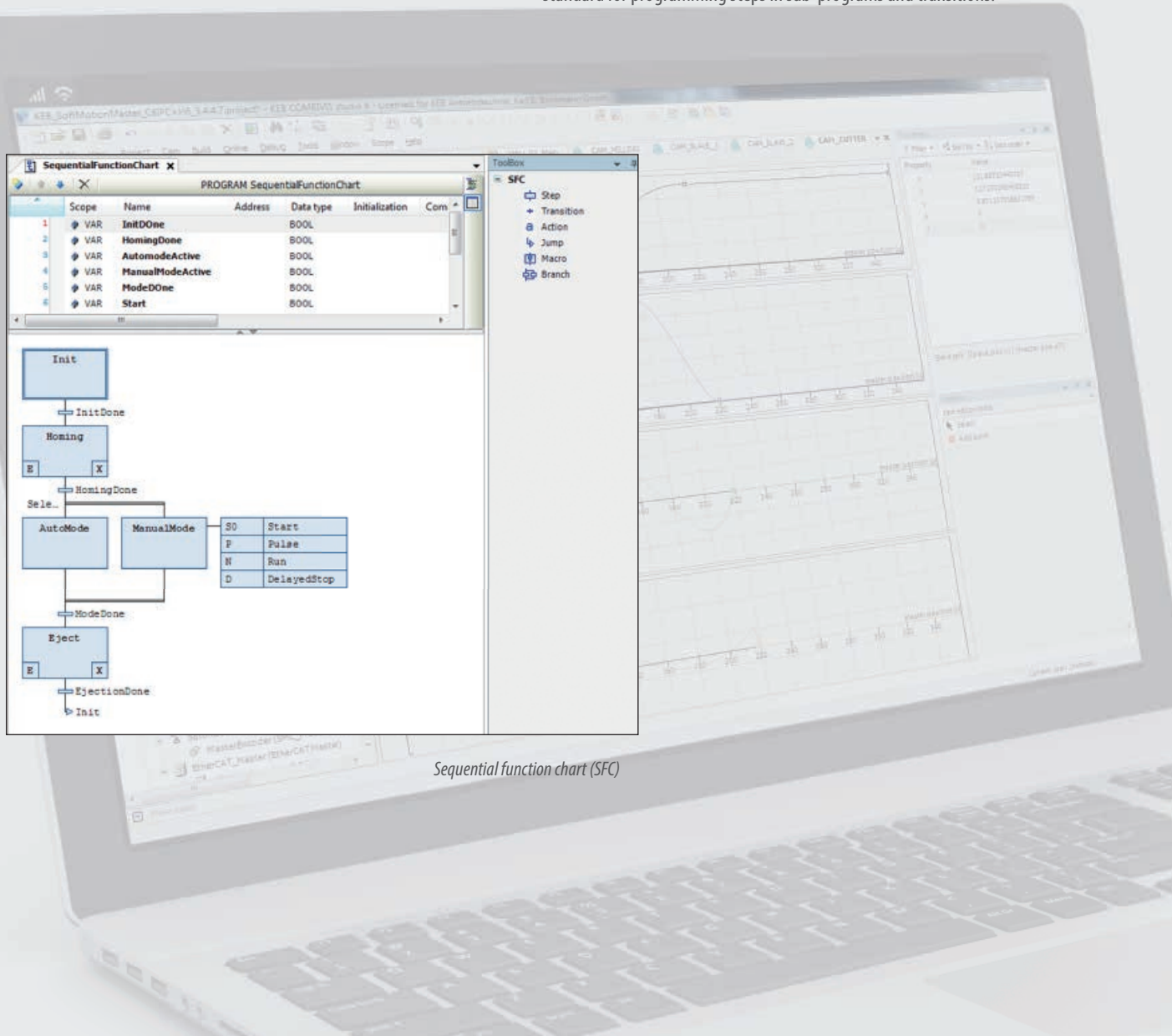

Sequential function chart (SFC)



HIGHLIGHTS

- Graphic state machines
- Definition of steps and transitions
- Programming of source codes of subprograms possible in any language

CONTINUOUS FUNCTION CHART (CFC)

Continuous function chart (CFC) is primarily a different implementation of the Function block diagram (FBD). In comparison to other step-based editors, the CFC user can also program continuous connections, for example feedback loops. The connection between inputs, operators and outputs are not automatic but the result of individual programming. The execution sequence can be adapted so that the user always retains complete control of the program.

This is indicated by small green figures in the top right-hand corner of each function block. The toolbox contains common tools such as comments, set/reset outputs, negation and jumps. In general, as a graphic language within IEC 61131-3, CFC lays the foundation for developers to depict their code in the best visual form. Automatic instance recognition and connections between preselected pins are also available.

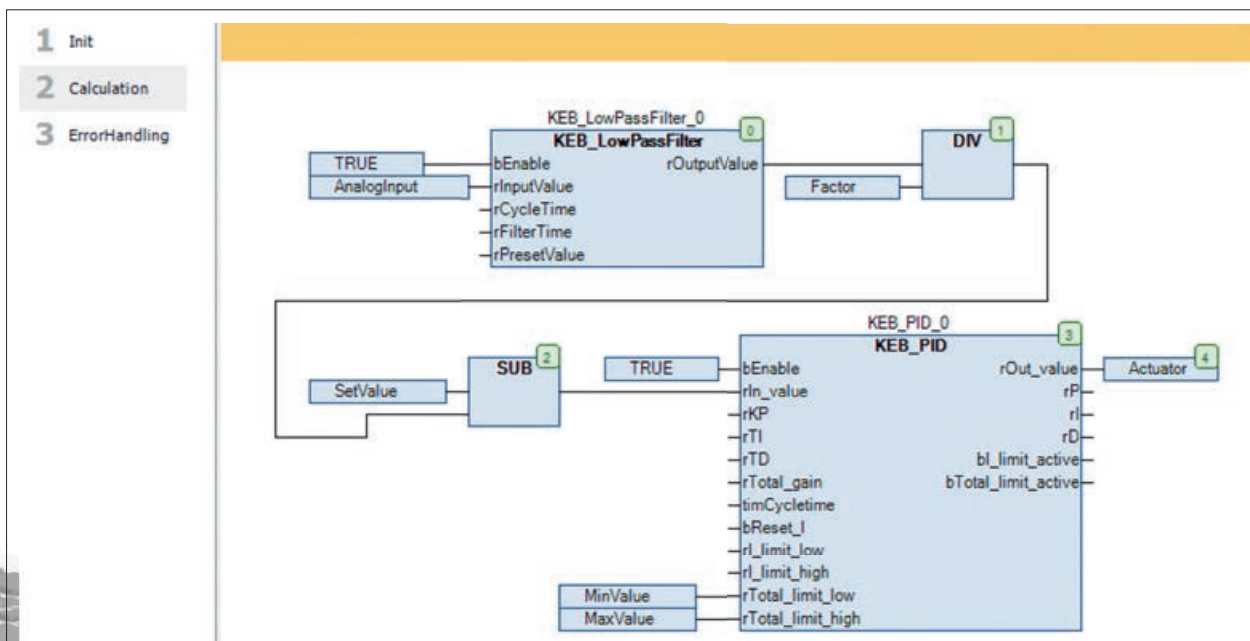

Continuous function chart (CFC)



HIGHLIGHTS

- Flexible graphic layout over entire drawing surface
- Cross connection and feedback options
- Perfect for regulator structures and interlinked modules

SMART CODING

KEB's COMBIVIS studio 6 automation platform offers the programmer numerous assistance systems. For example, the input and auto-declaration assistant shows the modules currently available and inserts these in compliance with the syntax. Thanks to functions such as auto-formatting, indentation, automatic code completion and syntax highlighting, KEB shortens the engineering times and at the same time makes it easier for beginners to learn IEC 61131-3 programming.

Highlighting errors before compiling, with the display of tool tips for error correction, is particularly helpful here.

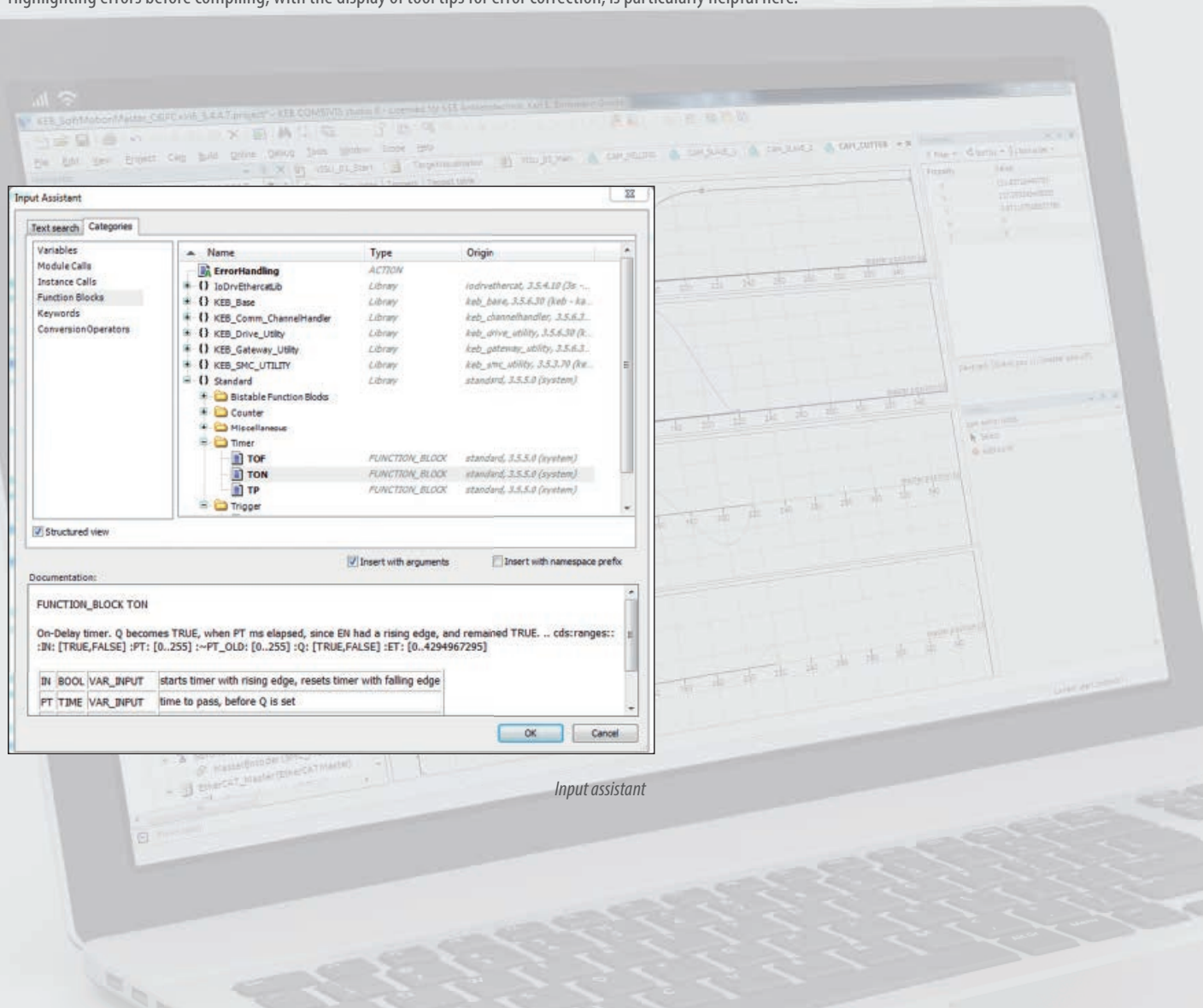

Input assistant



HIGHLIGHTS

- Input assistant with automatic declaration, completion and formatting
- Static analysis
- Syntax and error highlighting
- Refactoring
- Project comparison

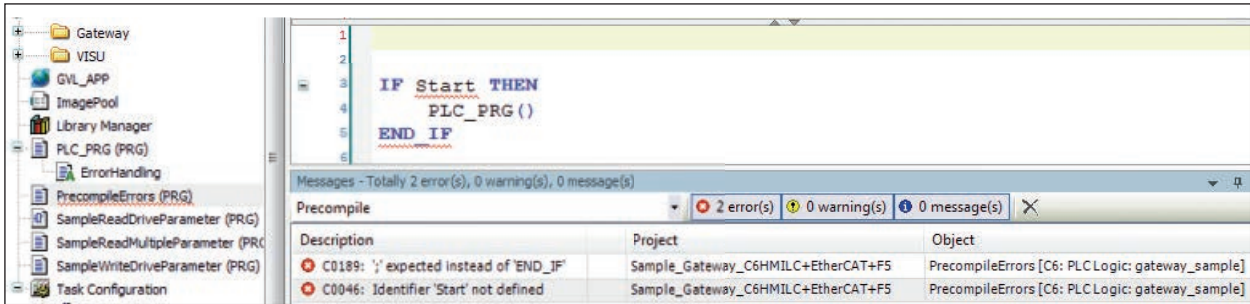

Error Highlighting

Via static analysis, the project can be checked for unused variables or duplicated memory access at any time. Refactoring makes it easier to change object-related module names and update programming standards at a later date.

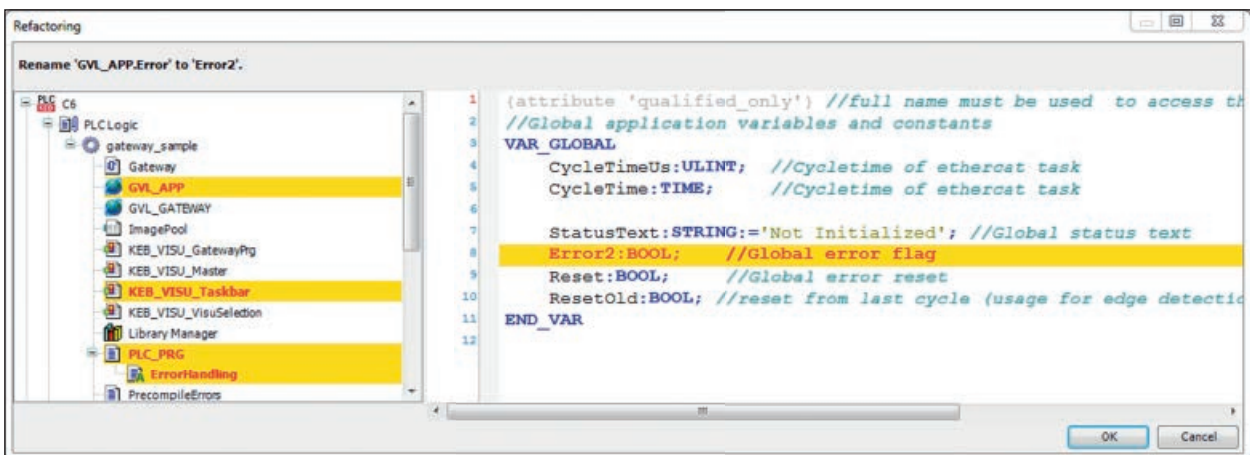

Refactoring

DEBUGGING AND WATCHING

In order for the programming developed in engineering to function securely in practice, intensive test routines are necessary. The function scope of COMBIVIS studio 6 includes, in parallel to user-friendly programming tools, powerful tools for debugging and start-up. Even in structurally sophisticated projects with a high number of subprograms and variables, rapid diagnosis and error correction is possible thanks to the debugging and watching function. Programmable stop points allow step-by-step sequence analysis.

The Call stack shows the retrieval order of different program parts. Sequence control allows the variable values for the runtime to be displayed simultaneously for each code line. If a variable is used in several program parts, the cross reference list helps switch directly between all points of use and also shows the access type, line number and declaration location.

The screenshot displays the 'Watch 1' window on the left, listing various expressions and their values. The 'Flow Control' window on the right shows a code snippet with line numbers 4 through 19. The code includes comments and variable assignments, such as 'Cnt[24181] := Cnt[24180]+1;' and 'IF Cnt[24183] >= CntMaxIntern:1000 THEN //Check limit'. A dropdown menu is visible next to 'setError' on line 13.

Cross Reference List

Name: bPowerDrives

POU	Variable	Access	Type	Scope	Address	Location	Comment
GVL_STATUS	bPowerDrives	Declaration	BOOL	Global		Line 6	
INIT_ENTRY	bPowerDrives	Write	BOOL	Global		Line 1, Column 1	
MOTION	bPowerDrives	Read	BOOL	Global		Line 16, Column 1 (Impl)	
MOTION	bPowerDrives	Read	BOOL	Global		Line 93, Column 1 (Impl)	
MOTIONMASTER	bPowerDrives	Read	BOOL	Global		Network 1 / Operand 'bPowerDrives' (Impl)	
READYTOSTART_ENTRY	bPowerDrives	Write	BOOL	Global		Line 1, Column 1	
RESETERRORS_ACTIVE	bPowerDrives	Write	BOOL	Global		Line 4, Column 1	



HIGHLIGHTS

- Read, write and assign values on-line
- Programmable stop points
- Sequence control
- Project comparison
- Call stack
- Cross reference list
- Event logger
- User-defined watching window
- Binary, decimal and hexadecimal switching
- Multichannel trends with trigger function

The trace function is designed for further analysis of multichannel diagrams in a ring memory with cycle precision. This creates the basis for comparing displayed nominal and actual values, or optimising run profiles with simultaneous depiction of position, speed, acceleration and jump.

Arbitrary variable states can also be used as a trigger condition. Each channel is scaled automatically or manually. The value tables can be exported and imported for further processing or back-up.

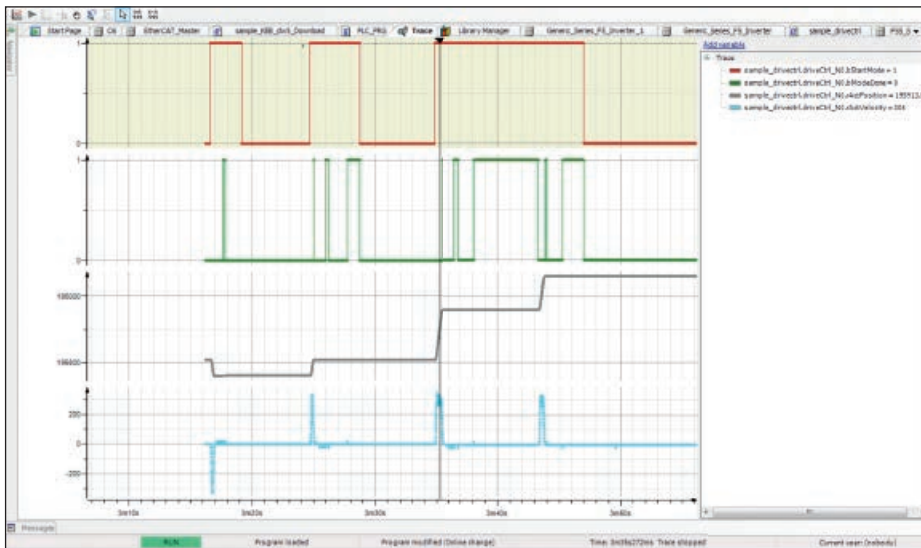

Trace

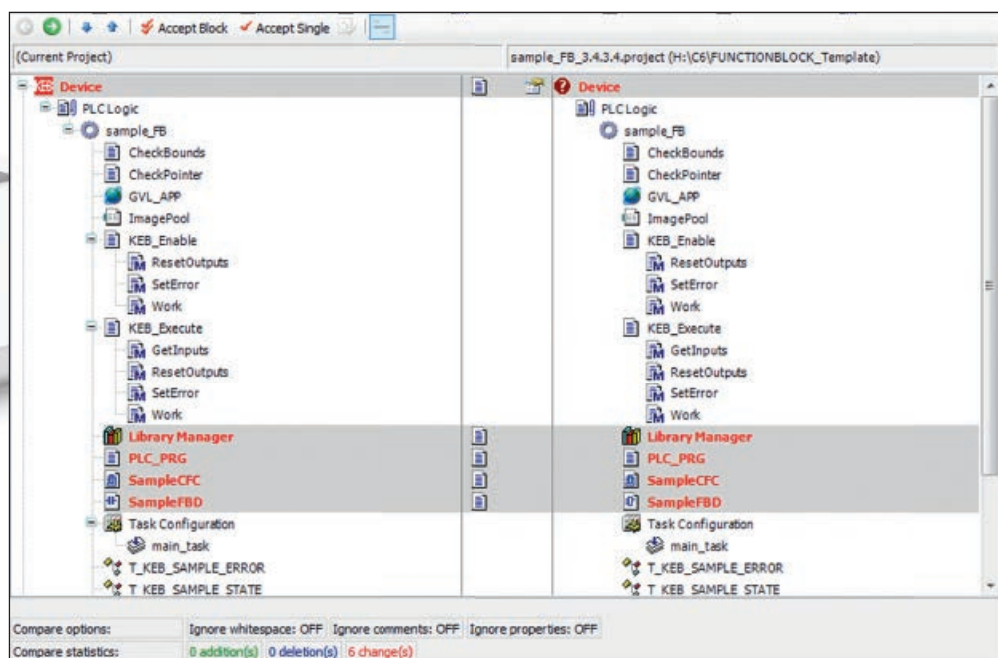

Project comparison

COMBIVIS studio 6

SIMULATION

Early testing and error location, instead of only beginning code debugging on start-up in the customer's system: because the real hardware is not usually available during programming, simulation tools are more important than ever. They create the basis for concentrating on the performance of the machine during start-up, instead of on the reliability of the software. COMBIVIS studio 6 therefore provides several simulators.

One of these is tailored for PLC logic in which variable values and source code behaviour can be tested and validated. COMBIVIS studio 6 also offers modern tools for simulation of the axis movement on the same PC on which the IDE is located. So the programmer has the opportunity to test not only the PLC logic but also the machine behaviour - even when the motor and communication system are not connected.

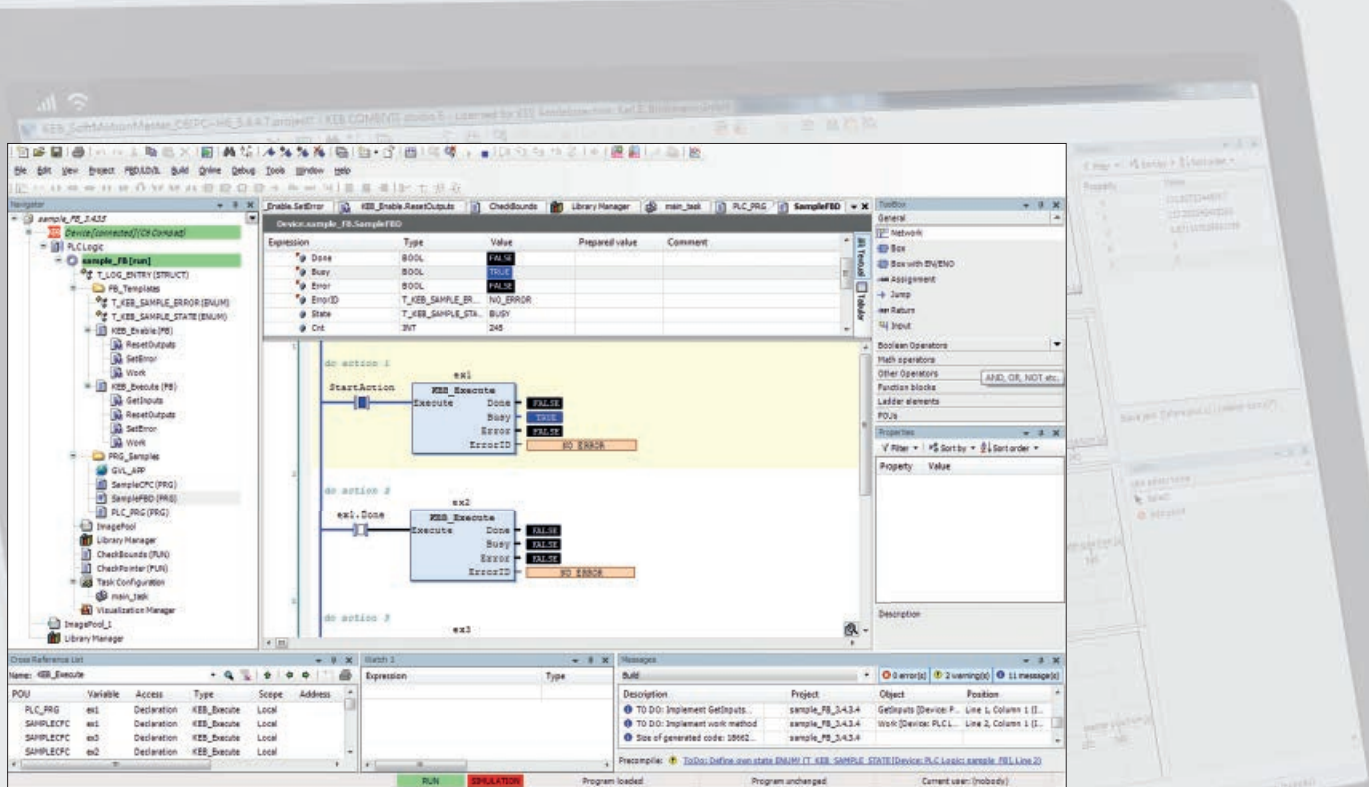

Online depiction

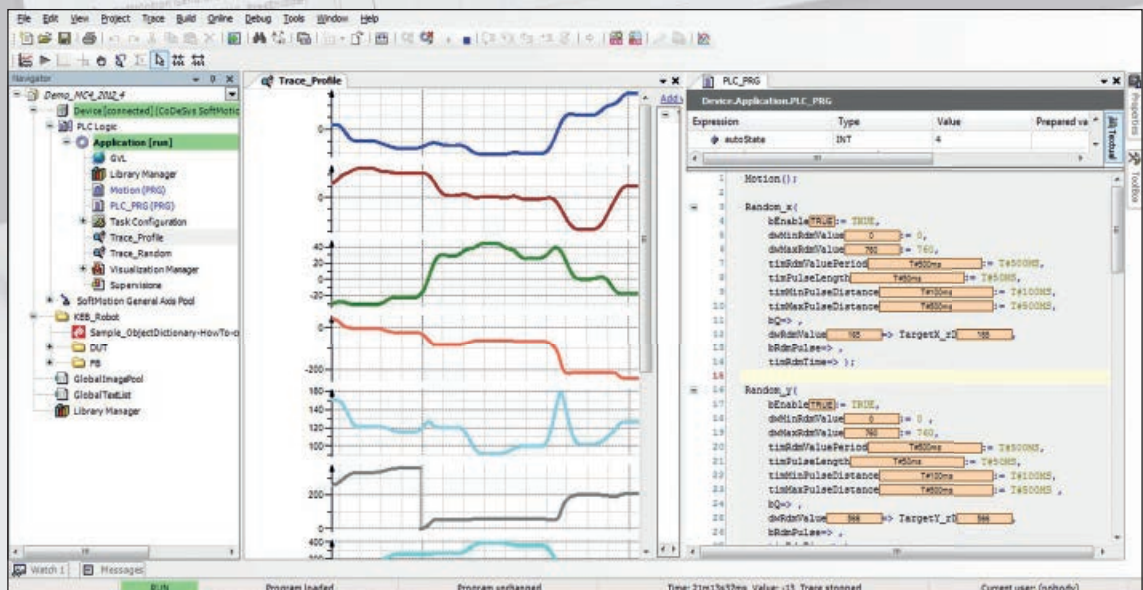

Trace recording

ASSISTANTS

On-line and off-line assistants are a firm component of COMBIVIS studio 6 - above all to make the engineering easier and quicker. The Motor configuration assistant for example allows access to the KEB motor database, and databases of other manufacturers or programmers. Also third party databases can easily be shared with other COMBIVIS studio 6 users. In addition, the programmers can produce complete process data mapping configurations using the Process data start assistant.

A second example of an efficiency-improving assistant is the Anti-cogging assistant, which was developed using KEB's full experience in the field of movement guidance. The background: in many cases, because of the internal structure and magnet alignment, cogging torque can occur in permanent magnet motors which is transmitted to the control loop and leads to instability or loss of precision. Using the Anti-cogging assistant, the user can effectively eliminate cogging torque in permanent magnet motors.

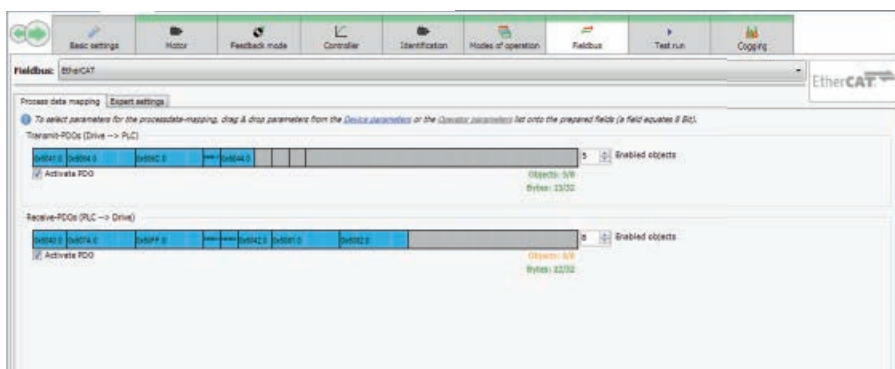

Process data mapping

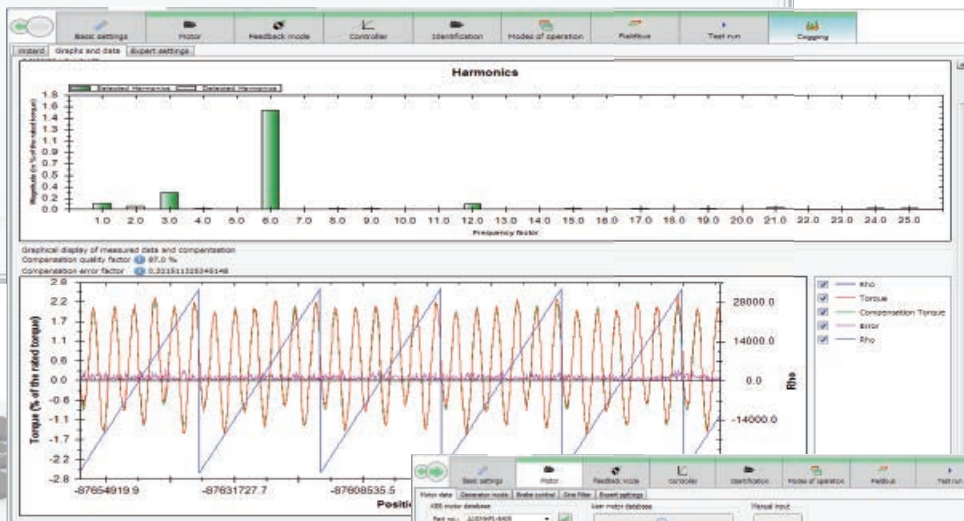

Anti-cogging

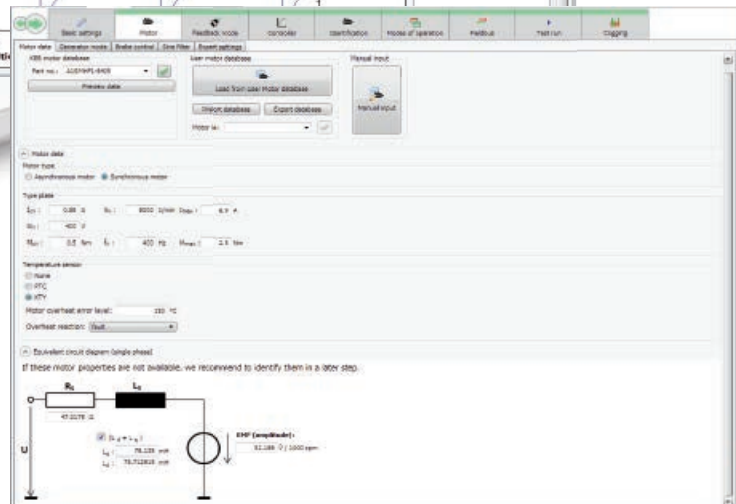

Motor database configurator

COMBIVIS CONFIGURATOR

The COMBIVIS Configurator is a tool for simple modelling of KEB automation systems. Various assistants and the intuitive graphic user interface ensure comfortable and rapid working. The configuration produced can be used in various ways after completion. Firstly it can be integrated 1:1 into a technical documentation or the parts list for a bid. Secondly, COMBIVIS or COMBIVIS studio projects can be generated from this. The configurator also simplifies access to the technical data and documentation of all devices from the KEB world of drive and automation.

PROJECT GENERATION

TECHNICAL DATA



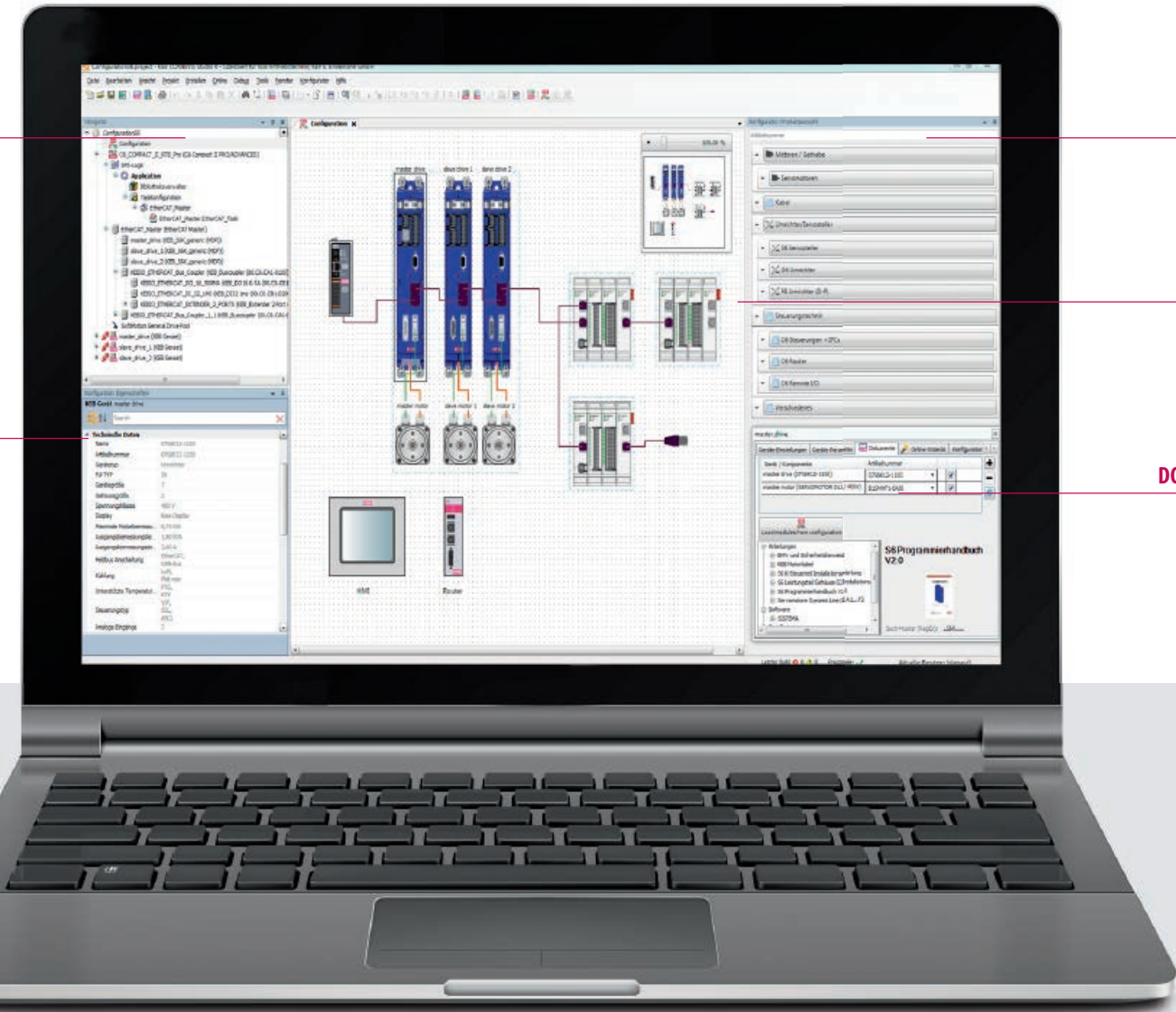

TOOLBOX

DESIGNER

DOCUMENTS



HIGHLIGHTS

- Access to current product database
- Intuitive assistant for product selection
- Access to technical data and documentation
- Display of all interfaces and connection components
- Extensive export function for parts lists
- Automated project generation

COMBIVIS STUDIO HMI: INTEGRATED VISUALISATION

With the aim of making professional visualisation as simple as possible, COMBIVIS studio HMI offers an extensive template library, powerful tools, and rapid and direct access to the process variables of the associated controller. At the same time, complex projects call for the facility for parallel processing of control and visualisation projects by several developers, beyond the limits of purely integrated solutions.

By linking visualisation and control projects, COMBIVIS studio 6 allows automated variable and driver exchange and parallel processing in our own SCADA designer COMBIVIS studio HMI.

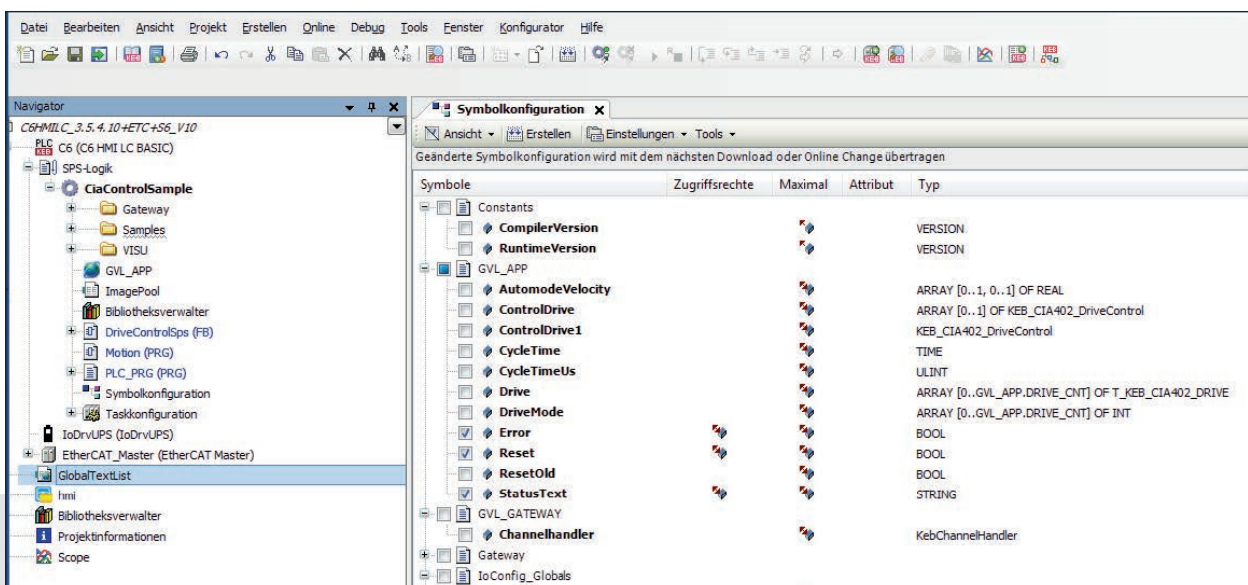

CONTROL



HMI



HIGHLIGHTS

- Automated driver and variable exchange
- Parallel development of HMI and control projects
- One HMI and multiple control sources
- Higher-level archiving possibilities

DOCUMENT DATABASE - ALWAYS UP-TO-DATE

Two clicks to documentation: The KEB document database gives the user a versatile and flexible knowledge database. Individually selected content is then also available off-line, for example during start-up. The database furthermore informs users of program updates and new content which can be updated automatically if required.

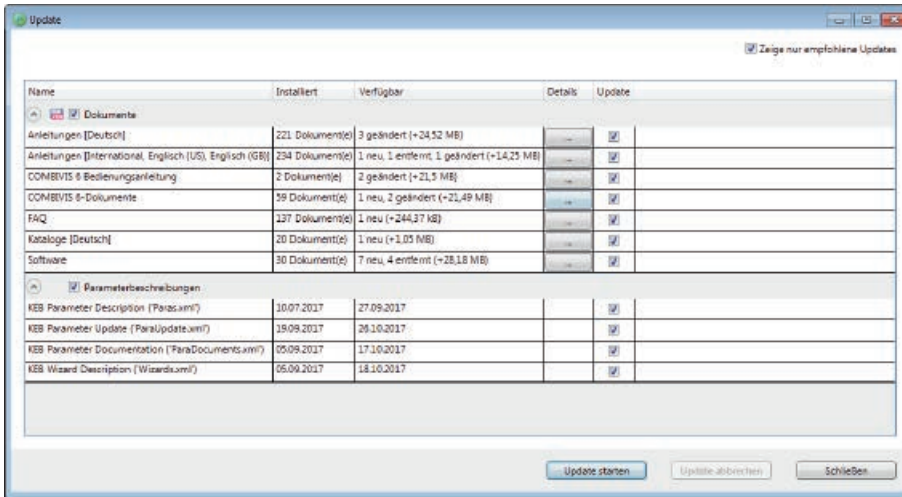

Simply right-clicking on a parameter immediately reveals the underlying detailed description. In addition all documents and files belonging to the product can be listed.

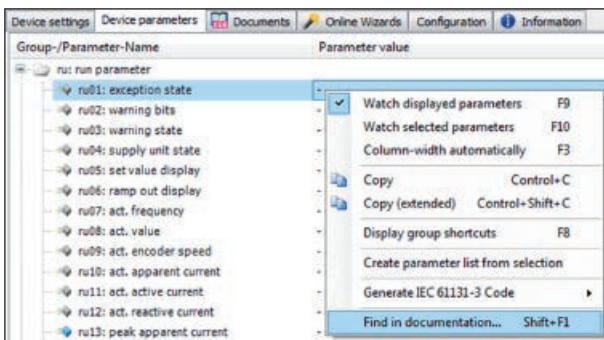

The faults are coded according to the following table:

ru01	Fault text	Description	st01
0	no exception	No error	0x0000
3	ERROR overcurrent PU	Overcurrent detection at the power circuit has triggered (e.g. short circuit, power module defective)	0x5400
4	ERROR overcurrent analog	exceeded over current level on the control card (e.g. incorrect setting of the controller or the torque limiting characteristic)	0x2300
5	ERROR over potential	Overvoltage in DC link (z.B. deceleration ramp too small, braking resistor not connected, braking transistor defective)	0x3210
6	ERROR under potential	Undervoltage in DC link	0x3220

1. Step

2. Step



HIGHLIGHTS

- Automatic online update
- Individual selection of off-line content
- Direct search function by parameter documents

COMBIVIS 6: START-UP, DIAGNOSIS AND OPTIMISATION OF DRIVES

Version 6 of the well-known KEB parameterisation diagnosis tool COMBIVIS 6 offers new tools for easier start-up and optimisation of drives. Assistants guide the user intuitively through the basic set-up of a drive. In expert view, extensive additional settings also create the basis for further fine tuning, to adapt the drive more closely to the respective application. Assistants are available for:

- Start-up
- Motor
- Encoders
- Encoderless regulated operation
- Drive control
- Safety
- Fieldbus analysis
- Cogging compensation

COMBIVIS 6 also contains a 16-channel oscilloscope, back-up functions for parameter back-up, and rapid online/off-line comparison.

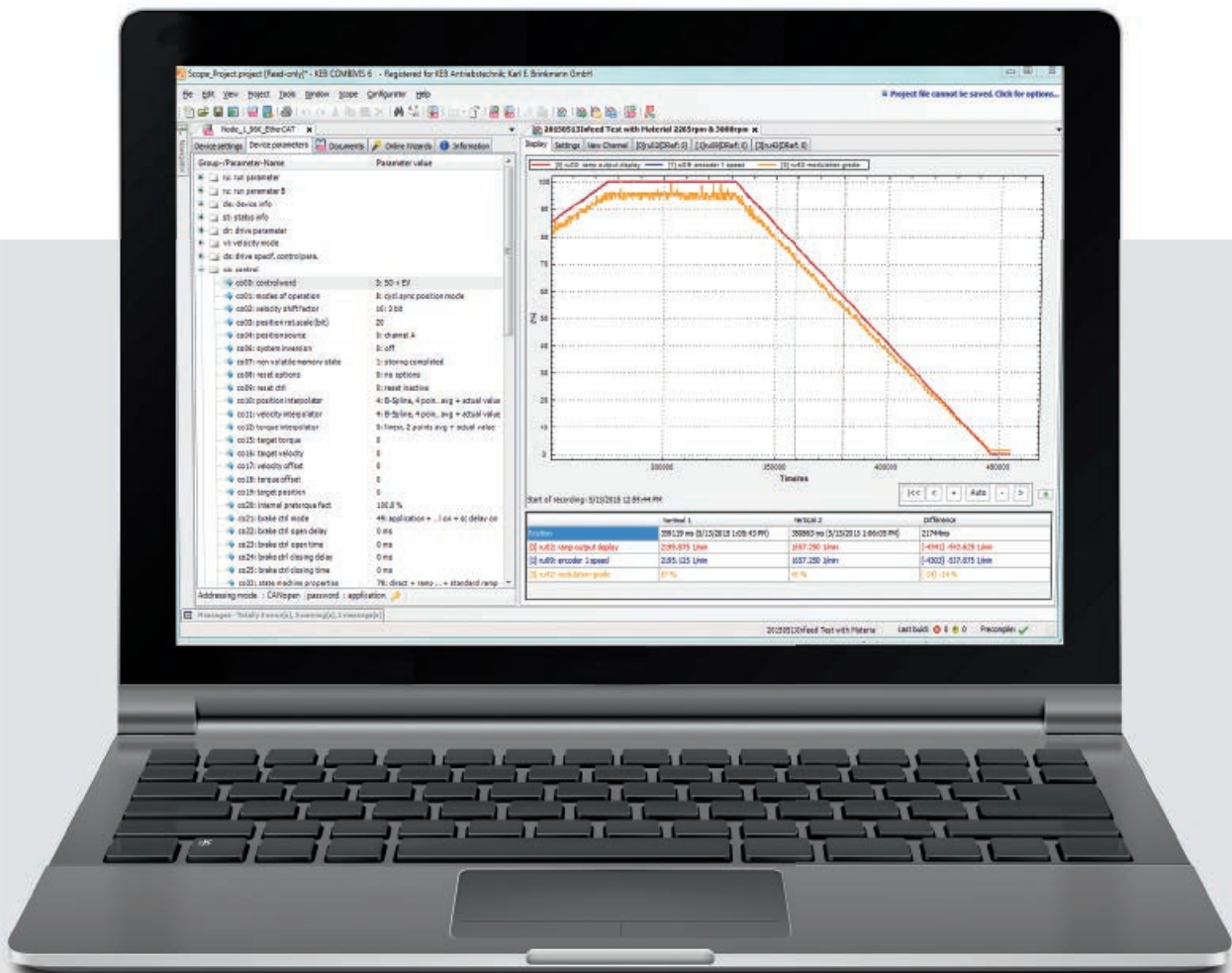

KEB CHANNEL HANDLER - MULTI-FIELDBUS GATEWAY

It's always good to understand each other. The KEB channel handler overcomes potential language barriers as the gateway provides the translation between the Ethernet world and the various fieldbus telegrams. The idea is to be able to simply connect Ethernet-based controllers with fieldbus devices - independent of fieldbus and topology.

The KEB channel handler clears the way for routing through numerous network layers to allow comfortable access to all subscribers of an automation system.

For example, without additional hardware, the software converts Ethernet queries into fieldbus telegrams with the correct node address. This creates the basis for diagnosis or parameterisation. Also, modular IEC 61131-3 components can be embedded in the PLC program in parallel to the application.

Because the parameter channel is generally used for the translation, the contact functions even during a synchronous process data communication in multi-axis applications.



HIGHLIGHTS

- Direct access to drive parameters by the network and fieldbus topology
- Multi-fieldbus gateway for EtherCAT®, CAN open, HSP5, Ethernet, serial RS232 /RS458, Profinet, Profibus, Interbus, Powerlink
- Flexible software solution
- Access even in synchronous operation

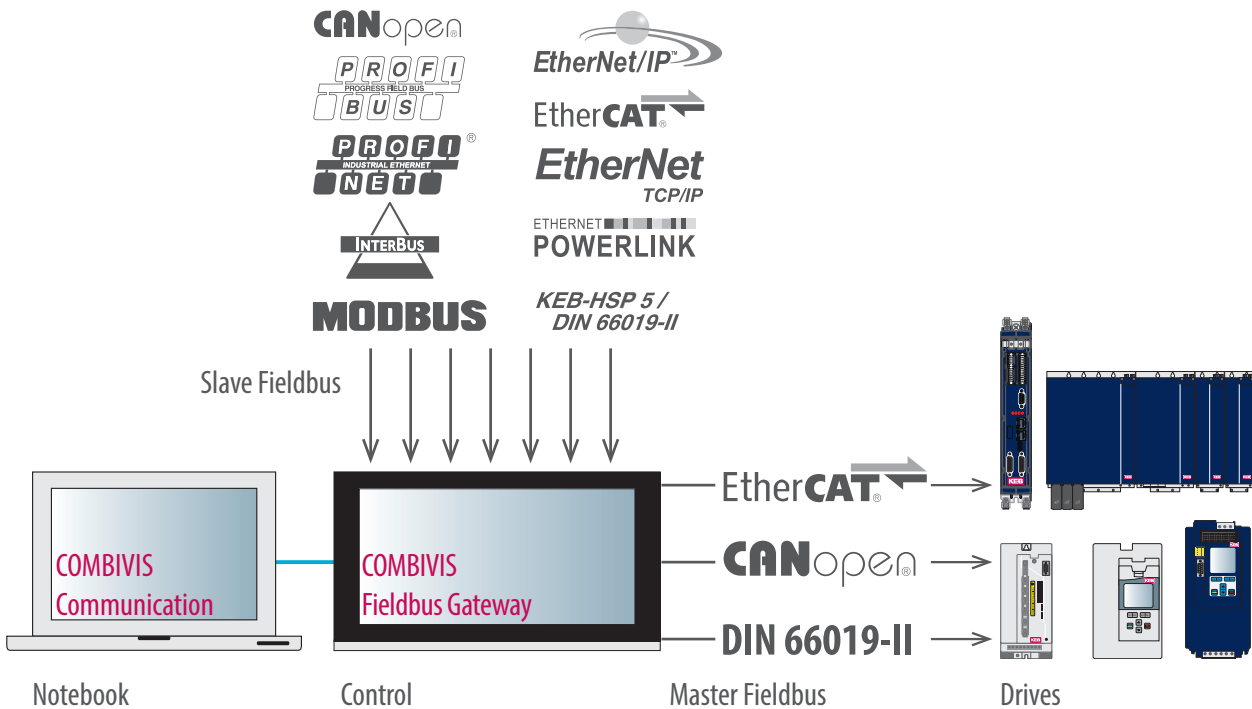



KEB



COMBIVIS studio 6 SAFETY

To complete the automation concept, KEB offers a fully integrated safety solution based on the development environment CODESYS SAFETY in the COMBIVIS studio 6 automation platform. This total solution allows freely programmable development for applications with safety standards IEC 61508 SIL3 and DIN EN ISO 13849-1 PL_e.

To allow maximum flexibility, based on existing EtherCAT® topology and without additional wiring, KEB offers the safety protocol Fail Safe over EtherCAT® (FSoE).



COMBIVIS studio 6 SAFETY



FUNCTIONAL SAFETY (FS)

Functional safety is one of the key topics of automation technology. As a result of the Machinery Directive and the Product liability law, the machine and plant construction industry is facing a new situation.

In general, functional safety must be taken into account in automation from the control system, at KEB this has led to development of whole system solutions in which safety functions are extensively integrated.

One consequence is that safety plays a key role in all components of a modern machine. In order to ensure that safety is not achieved at the cost of handling, suitable operating concepts are required to ensure that safe machines also remain competitive.



HIGHLIGHTS

- Integrated modular safety concept
- Safety over EtherCAT® (FSoE)
- Cross communication between PLC and safety PLC
- On-line monitoring of secure and insecure data
- SIL3 to IEC 61508
- PLe to DIN EN ISO 13849

SAFETY CONCEPT

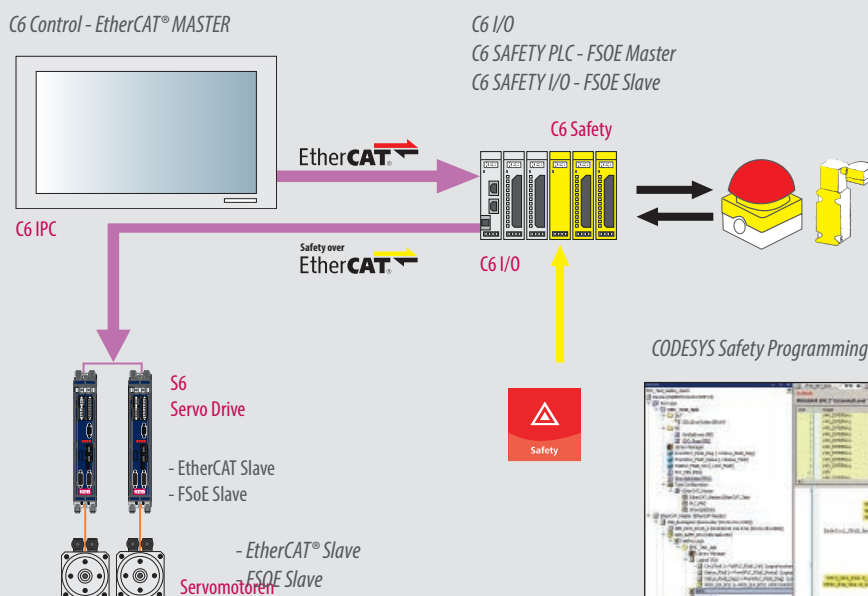

CODESYS Safety Programming in COMBIVIS studio 6

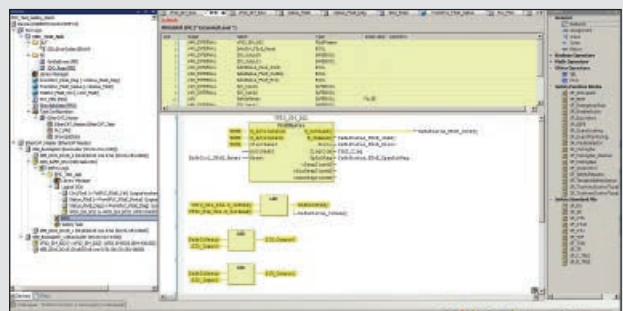

KEB SAFETY SYSTEM

We have expanded the C6 I/O module system. Thanks to safe inputs and outputs, the KEB automation platform can now be used for motion control applications with sophisticated safety requirements. Another notable point is that separate wiring of safety circuits is no longer required thanks to the integrated safety I/Os. Safe signals are transmitted together with the standard signals to the C6 Safety control system in the EtherCAT® protocol. This integration is based on the TÜV-certified safety protocol FSoE (Fail Safe over EtherCAT®). The KEB Safety System fulfills SIL 3 of IEC 61508.

FSoE: SAFETY OVER ETHERCAT

In parallel with the EtherCAT® development, a special protocol for functional safety has also been produced. The protocol and implementation of Safety over EtherCAT® (FSoE) are TÜV-certified and comply with Safety Integrity Level 3 (SIL3) to IEC 61508. Safety over EtherCAT® has been standardised internationally in IEC 61784-3-12 since 2010. Safety over EtherCAT® does not impose any restriction on transmission speed and cycle time, since EtherCAT® is used as a single-channel communication medium. The transport medium is regarded as the “Black Channel” and not included in the safety consideration.

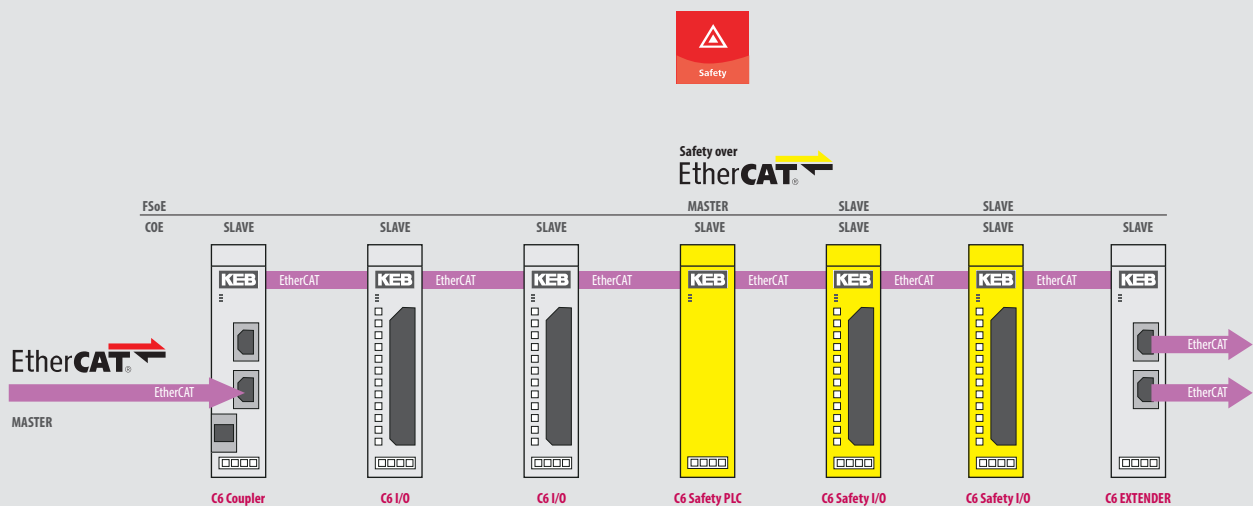



SAFETY PLC: CONTROL SYSTEM TECHNOLOGY WITH INTEGRATED SAFETY

Thanks to the flexible software architecture in which safety functions are an integral part of the user software, different safety functions can be freely programmed in the Safety PLC of KEB using the standardised languages of IEC 61131-3 (Codesys). The architecture of the Safety PLC is prepared for certification to the highest safety standards (SIL 3 to IEC 61508, PLe to DIN EN ISO 13849).

By design, the safety controller is adapted to the real-time environment of EtherCAT® and can be expanded universally in conjunction with KEB's modular I/O system. The decentralised structure is designed for direct installation in machines and plants without additional wiring complexity - and at the same time with little space requirement and rapid installation.

For the user, the Safety PLC meets all the conditions for implementing a safety concept without further certification expense. This includes the possibility of equipping existing plants with modern safety functions in a short time.

SAFETY I/O: CREATES MORE POSSIBILITIES

With the Safety I/O modules, KEB lays the foundations for extending the safety chain and integrating more tasks in the automation environment.

Modular terminal systems as inputs and outputs form the interfaces for signals or process parameters. Within the FSoE safety protocol, a Safety I/O module is now available which integrates safety chain tasks in the existing modular top-hat rail terminal system.

Safety I/Os fulfill SIL 3 to DIN EN ISO 61508, or Performance Level e (PLe) of DIN EN ISO 13849. In combination with the Safety PLC, the module can be used for the following safety functions:

- 4 x emergency off switch
- 4 x contact emitter
- 2 x light grid
- 2 x one-hand operation
- 2 x independent output functions



STANDARD PROGRAMMING WITH CODESYS SAFETY

The C6 Safety PLC is programmed with a certified plug-in which is fully integrated in the KEB COMBIVIS studio 6 development environment. The safety controller constitutes a sub-node of the standard controller.

This includes the application, task and global variable lists, POEs and logic I/Os. The entire system is programmed with the FBD Safety Editor in IEC61131-3 and certified modules to PLC Open Safety.

The software also offers additional functions for securing the safety function. These include change tracking, safe signal flow, safe versioning (pinning), separation of safe mode and debug mode.

Developers can use an extensive library in CODESYS Safety. Prepared function modules make work easier and engineering faster - and hence more economic.

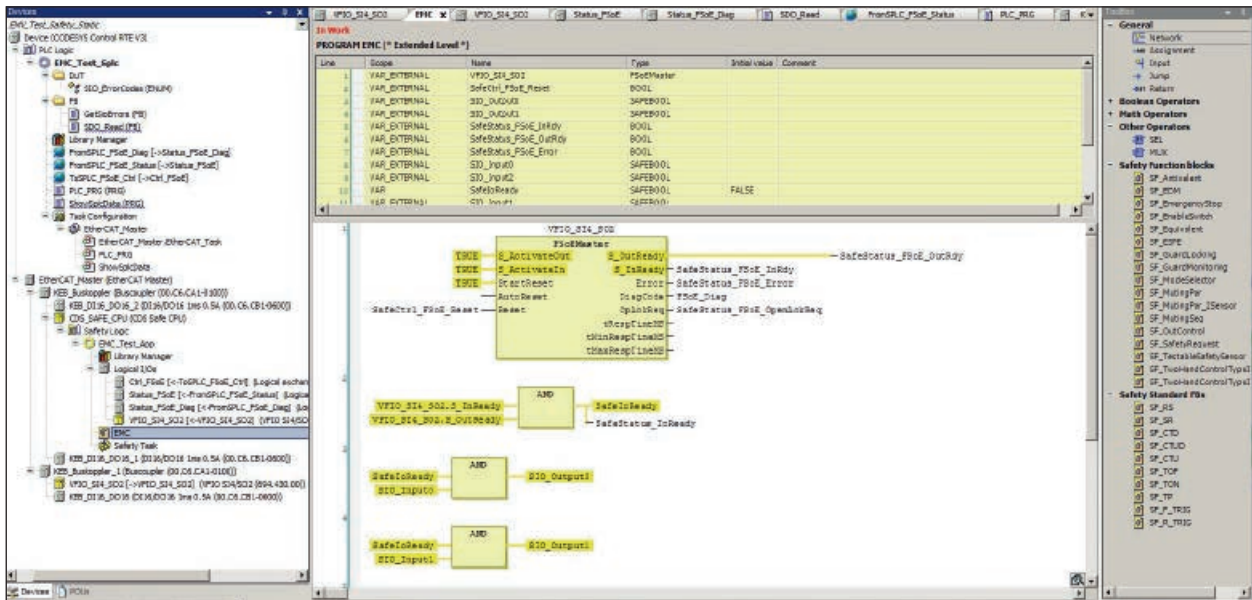

Safety-Editor



HIGHLIGHTS



- Integrated Safety-FBD Editor for programming
- Library for internal Safety Software modules such as emergency off, protected door monitoring, two-hand control etc.
- Configurator for Safety over EtherCAT® (FSoE)
- Data exchange with standard control
- Safe Download function with automated diverse compile checking



EDITOR FOR THE KEB DRIVE SAFETY MODULE

With the safety module editor, KEB offers users in the COMBIVIS 6 engineering environment a tool for configuration and analysis of the safety modules. The functions and values necessary for an application can be set off-line in order to be transmitted to the module on completion in just a few clicks. A useful feature for series applications or in service, is that the parameter lists produced with the safety module editor can be called at any time and transmitted again to further modules. A checksum ensures that the data has been correctly received. The data access itself can be freely configured and secured with password-dependent user rights.

- Part of the COMBIVIS 6 development environment
- Safe transfer of configuration data
- Rapid parameter list download for series machine construction
- Scalable user rights with six different password levels
- Status and error messages:
 - global status
 - status of safety functions
 - error status
 - status of inputs and outputs
 - current rotation speed
 - current position
 - system time and date

The screenshot shows the 'KEB Sicherheitsmodul' configuration window. It includes a user management section with 'Einloggen', 'Ausloggen', and 'Benutzereinstellungen' buttons. The user is logged in as 'Eingeloggte Benutzer-ID: 2' with 'Eingeloggter Benutzer-Level: 7: Volle Benutzerrechte'. The 'Sichere Parameter' section shows 'Sicherheitsmodul Version: 1.1.3.0' and 'Manuelle Auswahl' button. Below, there are 'Download', 'Upload', and 'Im/Export' buttons. The main area displays a table of parameters for a 'KEB Safety Device' (Parameter version: 1.1.3.0, Geräte-CRC: 0x2BF12546).

Parameter	Wert	Einheit
Filterzeiten der Sicherheitseingänge		
Filterzeit der STO-Eingänge	0.100000	s
Filterzeit der SBC-Eingänge	0.100000	s
Filterzeit der Funktion1-Eingänge	0.100000	s
Filterzeit der Funktion2-Eingänge	0.100000	s
Filterzeit der Ripple-Eingänge	0.100000	s
Taktsignal Eingangskonfiguration		
Testsignal-Periodendauer	10.000000	s
Testpulslänge	0.001000	s
Auswertung des Testsignals für die STO-Eingänge	aus	
Auswertung des Testsignals für die SBC-Eingänge	aus	
Auswertung des Testsignals für die Funktion1-Eingänge	aus	
Auswertung des Testsignals für die Funktion2-Eingänge	aus	
STO Eingangskonfiguration		
Toleranzzeit der STO-Eingänge	0.100000	s
Status der STO-Eingänge	äquivalent	
SBC Eingangskonfiguration		
Toleranzzeit der SBC-Eingänge		
Status der SBC-Eingänge		
Funktion1 Eingangskonfiguration		
Belegung der Funktion1-Eingänge		
Toleranzzeit der Funktion1-Eingänge		
Status der Funktion1-Eingänge		
Funktion2 Eingangskonfiguration		
Belegung der Funktion2-Eingänge		
Toleranzzeit der Funktion2-Eingänge		
Status der Funktion2-Eingänge		

A context menu is open over the 'Im/Export' button, showing options: 'Sichere Konfigurationsdaten exportieren', 'Sichere Konfigurationsdaten importieren', 'Parameterliste für Download erzeugen' (highlighted), 'Sichere Konfigurationsdaten aus Parameterliste importieren', and 'Default-Werte laden'.

Safe parameterisation

Produce parameter list

Node_1_H6_single_drive_unit KEB Sicherheitsmodul [Node_1_H6_single_drive_unit] X

Sichere Parametrierung Status Protokoll

Sicherheitsmodul Status

Allg. Sicherheitsstatus: 264706: Sicherheitsoperation freigegeben + Konfiguration Ok + Hochstarten des Sicherheit

Fehlerstatus: Kein Fehler

Letzter Fehler/Warnhinweis: Kein Fehler

Geberdrehzahl: 0,3750 1/min

Position (Umdrehungen): 0.0

H6 Istlagewert: -1

I/O Status: Eingangskanal 1: STO.1 + Ripple.1 + FUNC2.1
 Eingangskanal 2: STO.2 + Ripple.2 + FUNC2.2
 Ausgangskanal 1: VTRO.1 + VTRO.2 + Ripple Out.1
 Ausgangskanal 2: VTRU.1 + VTRU.2 + Ripple Out.2

Aktualisierungs-Einstellungen

Steuerkarten Parameter

Name	Online Wert
de41: safety type	2
de42: safety software version	1.1.3.0
de43: safety software date	20150330
sb29: safety mod. status word	258: Modu

Sicherheitsmodul LED

Blinken starten Blinken stoppen

Echtzeit-Uhr

Datum & Zeit Sicherheitsmodul:
01.09.2015 08:39:12

Datum & Zeit bearbeiten

Node_1_H6_single_drive_unit KEB Sicherheitsmodul [Node_1_H6_single_drive_unit] X

Sichere Parametrierung Status Protokoll

Kategorien: Fehler Sicherheitsfkt. Neue Konfig. Konfig. Fehler Einschalten Ausschalten

Index	Typ	Datum & Zeit	Details
0	0: Fehler	31.07.2015 15:36:13	536871249: Fehler: + Cpu 2 + Die Fehlerzeit für den Funktion2 Eingang ist abgelaufen.
1	0: Fehler	02.07.2015 07:40:02	884: Warnung: + Cpu 2 + STO Eingang gesetzt. Das Runterladen der neuen Konfig
2	0: Fehler	16.06.2015 11:00:10	884: Warnung: + Cpu 2 + STO Eingang gesetzt. Das Runterladen der neuen Konfig
3	0: Fehler	15.06.2015 12:14:39	536872321: Fehler: + Cpu 2 + Fehler in der Konfiguration des Sicherheitsmoduls. Di
4	0: Fehler	12.06.2015 13:51:53	884: Warnung: + Cpu 2 + STO Eingang gesetzt. Das Runterladen der neuen Konfig
5	0: Fehler	11.06.2015 14:47:13	536871265: Fehler: + Cpu 2 + Fehlerzeit für den STO Eingang ist abgelaufen. Der f
6	0: Fehler	11.06.2015 14:25:03	536872321: Fehler: + Cpu 2 + Fehler in der Konfiguration des Sicherheitsmoduls. Di
7	0: Fehler	06.02.2015 16:48:36	536872321: Fehler: + Cpu 2 + Fehler in der Konfiguration des Sicherheitsmoduls. Di
8	0: Fehler	06.02.2015 16:47:22	536872321: Fehler: + Cpu 2 + Fehler in der Konfiguration des Sicherheitsmoduls. Di
9	0: Fehler	06.02.2015 16:46:21	536872321: Fehler: + Cpu 2 + Fehler in der Konfiguration des Sicherheitsmoduls. Di
10	0: Fehler	06.02.2015 15:24:27	868: Warnung: + Cpu 2 + Die Geräte-Seriennummer ist nicht in Ordnung. Die neue
11	0: Fehler	06.02.2015 11:55:25	882: Warnung: + Cpu 2 + Runterladen der neuen Konfigurationsdaten fehlgeschlag
12	0: Fehler	01.02.2015 15:04:26	884: Warnung: + Cpu 2 + STO Eingang gesetzt. Das Runterladen der neuen Konfig
13	0: Fehler	27.01.2015 16:26:37	884: Warnung: + Cpu 2 + STO Eingang gesetzt. Das Runterladen der neuen Konfig
14	0: Fehler	06.01.2015 13:36:36	536871265: Fehler: + Cpu 2 + Fehlerzeit für den STO Eingang ist abgelaufen. Der f
15	0: Fehler	06.01.2015 11:43:54	536870995: Fehler: + Cpu 2 + Fehlerzeit für den Ripple Eingang ist abgelaufen. Der
16	0: Fehler	06.01.2015 11:29:35	1715: Warnung: + Cpu 2 + Fehler im externen Datenspeicher. Ein Busfehler wurde
17	0: Fehler	06.01.2015 11:29:35	1073743266: Kritischer Fehler: + Cpu 2 + Fehler im Sicherheitsausgang 1. Der gese
18	0: Fehler	06.01.2015 11:17:11	1715: Warnung: + Cpu 2 + Fehler im externen Datenspeicher. Ein Busfehler wurde
19	0: Fehler	06.01.2015 11:17:11	1073743266: Kritischer Fehler: + Cpu 2 + Fehler im Sicherheitsausgang 1. Der gese
0	4: Übernahmezeitpunkt der neuen Konfiguration	02.07.2015 07:40:31	Benutzer-ID: 2
1	4: Übernahmezeitpunkt der neuen Konfiguration	16.06.2015 12:07:38	Benutzer-ID: 2
2	4: Übernahmezeitpunkt der neuen Konfiguration	16.06.2015 12:01:17	Benutzer-ID: 2
3	4: Übernahmezeitpunkt der neuen Konfiguration	16.06.2015 11:56:54	Benutzer-ID: 2
4	4: Übernahmezeitpunkt der neuen Konfiguration	16.06.2015 11:44:28	Benutzer-ID: 2
5	4: Übernahmezeitpunkt der neuen Konfiguration	16.06.2015 11:37:07	Benutzer-ID: 2
6	4: Übernahmezeitpunkt der neuen Konfiguration	16.06.2015 11:00:26	Benutzer-ID: 2
7	4: Übernahmezeitpunkt der neuen Konfiguration	16.06.2015 10:58:43	Benutzer-ID: 2

Status of safety module

Safety module protocol



HIGHLIGHTS

- Part of COMBIVIS 6
- Safe transfer of configuration data
- Setting for series cases by parameter list download
- User rights with six different password levels



Wuchtanlage Status
15:00:40

Einstellungen Unwuchtsmessung

Kalibrieren

Soll Drehzahl [rpm] Restunwucht [gmm]

Unwuchtdaten

Position	Wert [gmm]	Winkel [°]
-1	0.1	316

Korrekturdaten

Position	Bohrtiefe [mm]	Bohrwinkel [°]
1	0.5	0.0

Akt. Soll Bohrtiefe mm

Meldung Letzte Position erreicht, Schutzhaube kann geöffnet werden

KEB

KEB



CONTROL RUNTIME FUNCTIONALITY



CONTROL Basis for PLC and motion control functionality. This symbol is placed by the hardware available.



BASIC Basic function scope for the KEB automation platform (IEC 61131-3 Standard and KEB Basic libraries).



PRO Professional function scope for the KEB automation platform (cam discs, electronic gears, angle synchronization).



ADVANCED Advanced function scope for the KEB automation platform (CNC functionality, G-Code, prepared movements).

CONTROL RUNTIME

BASIC FUNCTIONALITY



The entry-level product for the KEB range of control systems is CONTROL Runtime Basic. Even at the basic level, the real-time program core guarantees the deterministic behaviour with a jitter in the μs range. This clears the way for true multitasking without program-induced restrictions.

Deterministic communication channels such as EtherCAT® or CANopen today offer the possibility of using decentralised drive hardware simultaneously as remote I/O points. Also, digital cam switchgear can be achieved via the incremental encoder positions, without additional hardware.

KEB's basic solution is generally suitable for movement controllers in which the tasks are divided over controller and drives.

KEB_TappetGenerator	
-bEnable	bOutput
-rActPosition	bError
-rStartpoint	sErrorText
-rEndpoint	rPretriggerOffset
-timOutOnTime	
-rPositionPeriod	
-timCycleTime	
-timPretriggerTime	
-rVelocity	



HIGHLIGHTS

- Editors, functions and libraries are already fully available, right from the basic version
- Function modules for movement and control of drives shorten the engineering
- Standard equipment: versatile communication facilities from control to field level

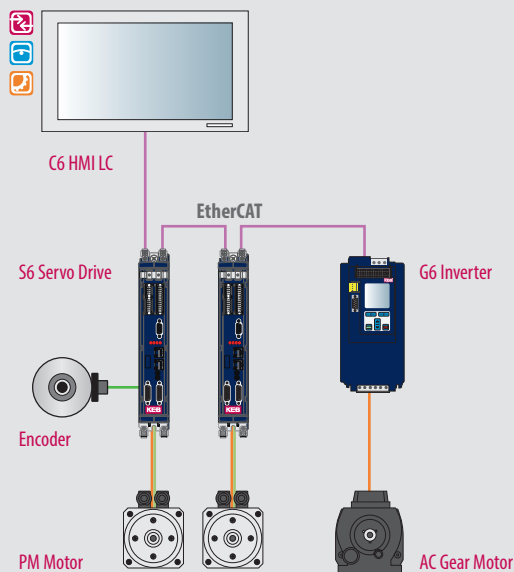

More comfort is provided by simple function block interfaces with which the desired movements of the KEB drives can be programmed more easily. Both movements and administrative tasks can be operated with one module. These program function blocks can be executed in cyclic or acyclic communication mode, since the motion profiles are produced within the KEB drives. Because of the continuity within the KEB engineering software, the axis data is available throughout a project.

- Point-to-point positioning
- Rotation speed control
- Rotation speed and torque control in encoderless operation with ASCL (*) and SCL (**)
- Motor control with feedback

keb_drivectl_f5a	
☐ KEB_CH_REF	bInitDone
☐ ProcessData_REF	DriveState
☐ KEB_Drive_REF	bError
iTargetNode	iErrorID
dwIncrementsRot	bDriveError
rRatio	iDriveStatusID
rUnits	RequestedDriveMode
bEnable	ActualDriveMode
bEnableVoltage	rActVelocity
bEnableQuickStop	rActPosition
bReset	bQuickStopActive
DriveMode	bLimitActive
bStartMode	bBusSynchronActive
rMaxVelocity	bHomingDone
rVelocityProportion	bPositionReached
Direction	bVelocityReached
rPosition	bModeDone

KEB_CIA402_DriveControl	
☐ DriveRef	FbError
Enable	FbErrorID
SwitchOn	DriveError
EnableVoltage	ActualState
NoQuickStop	ActualMode
EnableOperation	RequestedMode
FaultReset	ModeActive
Mode	VelocityActualValue
Halt	PositionActualValue
NewSetPoint	InternalLimitActive
RelativeMode	TargetValueIgnored
StartHoming	FollowingError
HomingMethod	SynchActive
TargetPosition	TargetReached
TargetPositionSync	SetPointAckn
TargetVelocity	HomingError
ProfileVelocity	HomingDone
EndVelocity	HomingState

* KEB-specific drive functions for regulated operation of three-phase motors without encoder feedback.

** KEB-specific drive functions for regulated operation of PM motors without encoder feedback.

CONTROL RUNTIME

BASIC FUNCTIONALITY



Libraries, communication drivers and all fundamental features of COMBIVIS studio 6 are already available in the BASIC level. Because communication with other systems is still one of the decisive topics in automation, the KEB control system is designed to be open and flexible in all directions from Ethernet communication to the established fieldbus.

KEB supports users in programming with tools and prepared function modules - for basic functions in the same way as for sophisticated applications.

- Complex PID regulators,
- Ramp generators
- Drive functions
- FTP and web servers
- Temperature regulators
- File handling

KEB CONTROL TECHNOLOGY SPEAKS DIRECTLY TO THE FOLLOWING FIELDBUS PROTOCOLS:

EtherCAT[®]

CANopen[®]

ETHERNET
POWERLINK

EtherNet/IP[®]



PROFI
PROGRESS FIELD BUS
BUS

KEB-HSP 5 /
DIN 66019-II

EtherNet
TCP/IP

MODBUS

PROFI[®]
INDUSTRIAL ETHERNET
NET

KEB_DW5_DOWNLOAD	
KEB_CH_REF	bDone
bEnable	bDelayActive
sFileName	iErrorID
iTargetNode	dwLine
	sError
	wAddress
	wMode
	iSet
	diValue

KEB_PID	
bEnable	rOut_value
rIn_value	rP
rKP	rI
rTI	rD
rTD	bi_limit_active
rTotal_gain	bTotal_limit_active
timCycletime	
bReset_I	
rI_limit_low	
rI_limit_high	
rTotal_limit_low	
rTotal_limit_high	

KEB_SMTP_SEND_MIME	
bEnable	bDone
bReset	bError
sGateway	uFileBytesLeft
sSendTo	sServerResponse
sSendFrom	diResult
sSubject	
pMessage	
diMessageSize	
sFilePath	
sFilename	

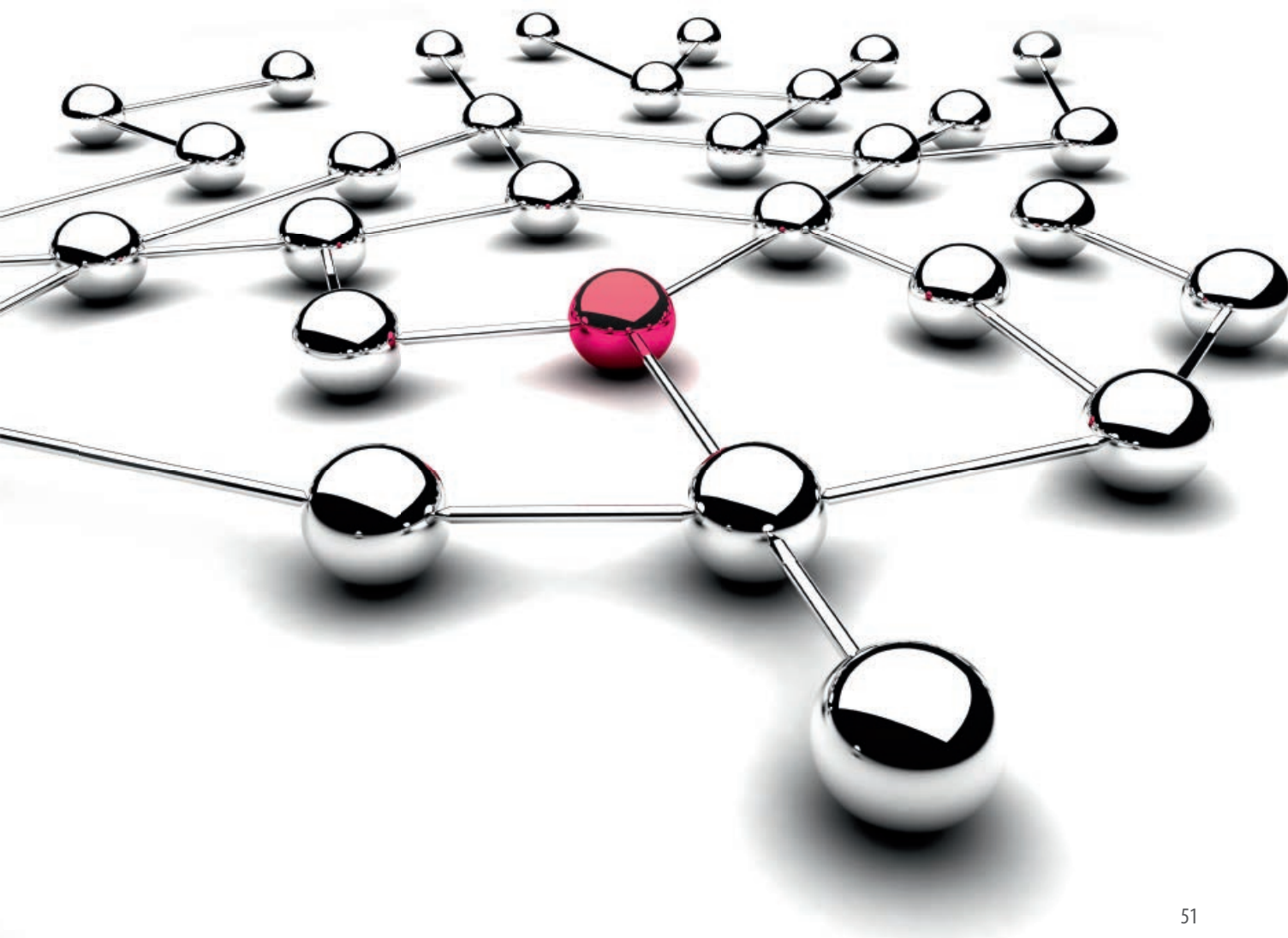

CONTROL RUNTIME

PRO FUNCTIONALITY



As an extended solution, CONTROL Runtime PRO is also based on the programming standards IEC 61131-3 and PLC Open. The controllers and their interfaces to the drive regulators work with open, manufacturer-independent commands which correspond to the definitions of the PLC Open user organisation. The result is maximum flexibility in the choice of devices and code portability even if different manufacturer platforms are used on the controller side.

In the PRO solutions, the system transfers the movement profiles of all axes via the deterministic communication bus. In this way the number of possible profiles is unlimited and the profile itself can be changed in one movement cycle with a short reaction time. KEB offers an efficient solution for current and future machine developments.



HIGHLIGHTS

- Motion control in real-time
- Adaptation of the movement task on the fly
- Simple conversion into application units
- Axis control libraries create order

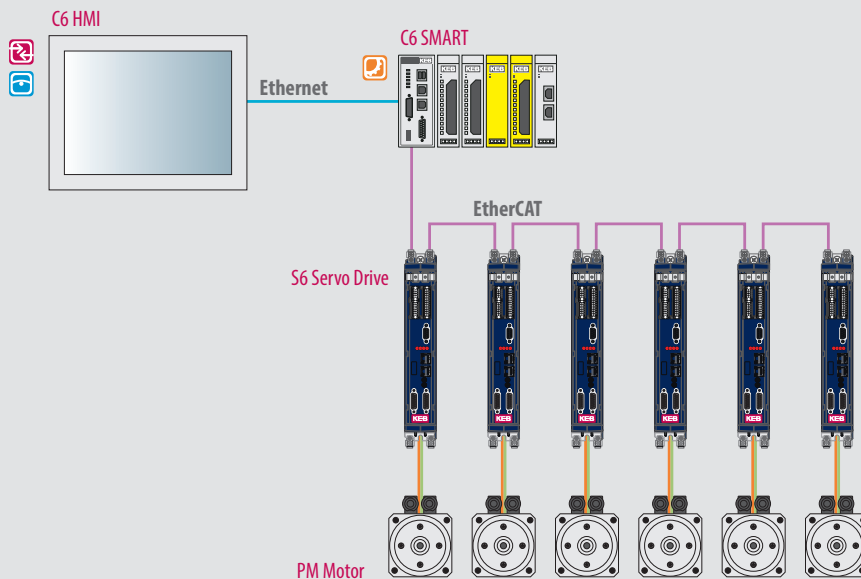

Beyond the basic level, CONTROL Runtime PRO offers additional libraries and graphic tools for the implementation of complex mechanical movement functions. What the tools produce is managed within the PLC program. So the setup of a machine can be changed very easily on a product change by recipe management.

Consequently, the time required for unproductive changeover is reduced. Another detail of the PRO Version: with the Abstract Drive Interface, KEB provides technology which can control various hardware types (drives, axes, hydraulics) in a project in one and the same way.

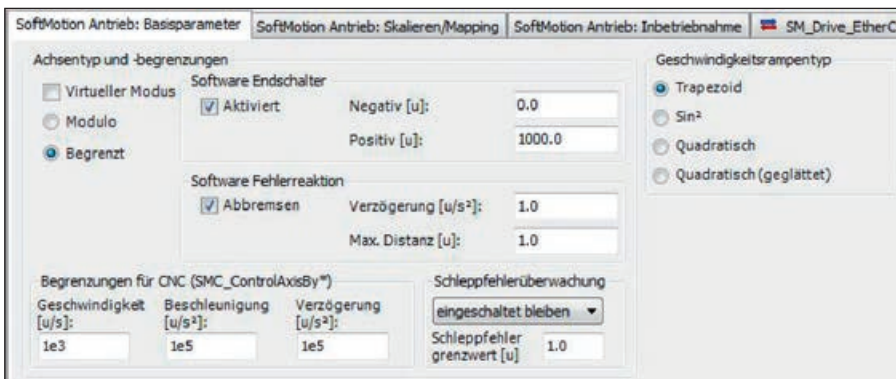

Axis configuration

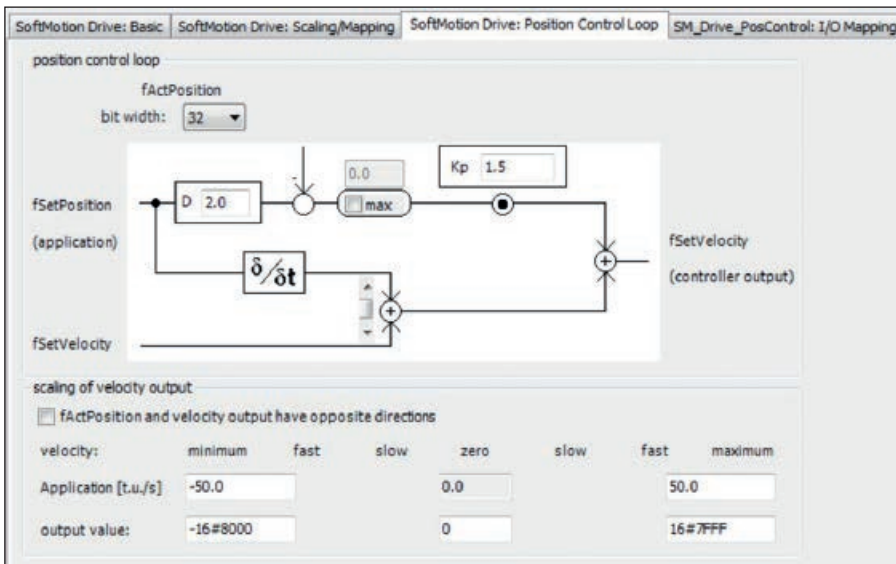

Configuration of external actuators

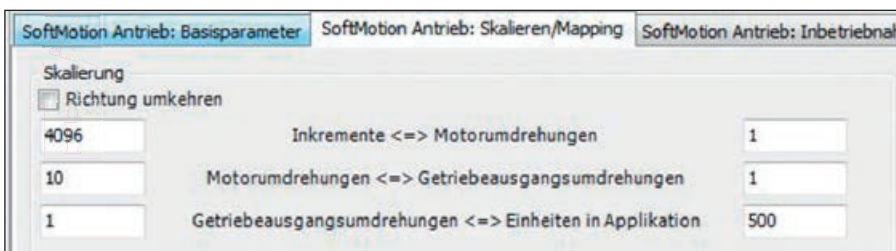

Axis scaling

PRO FUNCTIONALITY



DRIVE LIBRARIES

In automation, libraries serve the purpose of storing content so that it can be used again in a similar way for other projects, with very little to zero adaptation cost. The library areas of COMBIVIS studio 6 are therefore designed so that drives can be integrated more quickly or movement profiles programmed more efficiently.

The KEB Axis Utility library thus constitutes a proven means for greatly reducing project development time. The axis control solutions range from simple speed or positioning modes to complex synchronised movement tasks, such as cam discs, electronic gears or angle synchronisation.

Thanks to the combination of languages of IEC 61131-3 and integrated input aids, programmers can simply add an axis, select the movement behaviour and monitor the axis status - all with one function block.

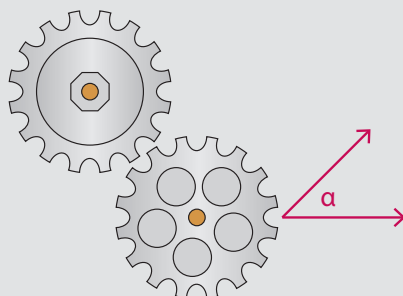
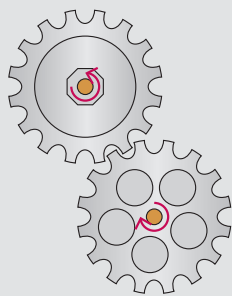

KEB_SingleAxisControl	
InverterEnable	AxisState
Reset	RequestedAxisMode
AxisMode	ActualAxisMode
Start	HomeDone
Position	Powered
Velocity	Done
Direction	Active
Acceleration	Stopped
Deceleration	InverterError
Axis	InverterErrorID
	FBError
	FBErrorID
	ActPosition
	ActVelocity

KEB_GearAxisControl	
InverterEnable	AxisState
Reset	RequestedAxisMode
AxisMode	ActualAxisMode
Start	HomeDone
Position	Powered
Velocity	Done
Direction	Active
Acceleration	Stopped
Deceleration	InverterError
RatioNumerator	InverterErrorID
RatioDenominator	FBError
Master	FBErrorID
Axis	ActPosition
	ActVelocity

KEB_PhasingAxisControl	
InverterEnable	AxisState
Reset	RequestedAxisMode
AxisMode	ActualAxisMode
Start	HomeDone
Position	Powered
Velocity	Done
Direction	Active
Acceleration	Stopped
Deceleration	InverterError
PhaseShift	InverterErrorID
Master	FBError
Axis	FBErrorID
	ActPosition
	ActVelocity

CAM EDITOR

The graphic editor of COMBIVIS studio 6 gives users a powerful tool with which they can produce and digitally manage cam profiles. System developers appreciate the layout options most. These extend from linear or spline interpolators to loss compensation for cam switchgear.

Cam profiles are stored in table form and can be changed in real-time via the IEC function blocks. So developers can store many cam profiles directly in the control system for retrieval at any time.

KEB_CamAxisControl	
InverterEnable	AxisState
Reset	RequestedAxisMode
AxisMode	ActualAxisMode
Start	HomeDone
Position	Powered
Velocity	Done
Direction	Active
Acceleration	Stopped
Deceleration	EndOfProfile
Periodic	Tappets
MasterAbsolute	SlaveStartPosition
SlaveAbsolute	InverterError
MasterOffset	InverterErrorID
SlaveOffset	FBError
MasterScaling	FBErrorID
SlaveScaling	ActPosition
StartMode	ActVelocity
TappetHysteresis	
CamTable	
Master	
Axis	

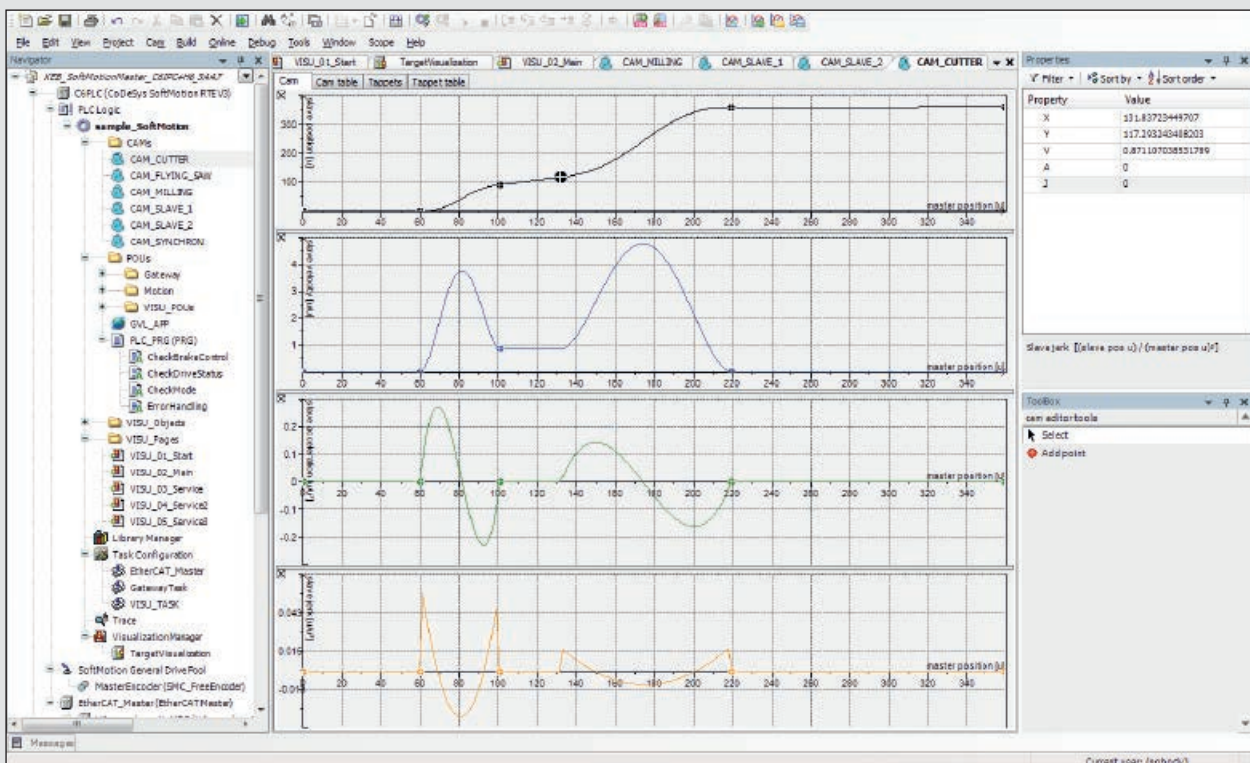
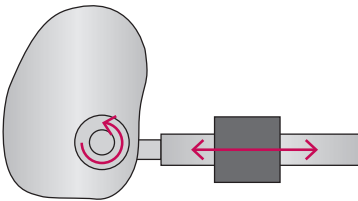

Cam disc editor

CONTROL RUNTIME

ADVANCED FUNCTIONALITY



If CNC functions are required in an application, CONTROL Runtime ADVANCED is used. This extension to the PRO solution contains CNC transformation libraries and the CNC language interpreter to DIN 66025 (G-code).

The CNC library contains function blocks in order to use internally stored NC files for the project, or load external NC files (ASCII/.txt files). The combination of KEB control and ADVANCED functionality allows more complex tasks to be processed, with over 30,000 ISO code process lines, while simultaneously retaining the standard SPS flexibility. Predefined graphics templates also allow the simulation of movements and entire applications.

In general, CONTROL Runtime ADVANCED has no fixed performance limits. The limiting parameters therefore are only the computing performance of the control system and the transmission speed of the bus system.

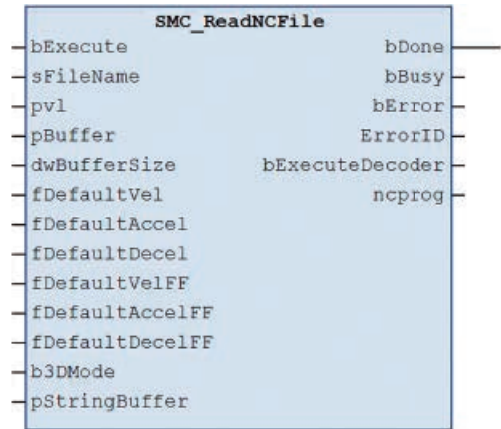

HIGHLIGHTS

- CNC G-code to DIN66025
- Higher function scope with low programming complexity
- Numerous movement, safety functions and transformations included

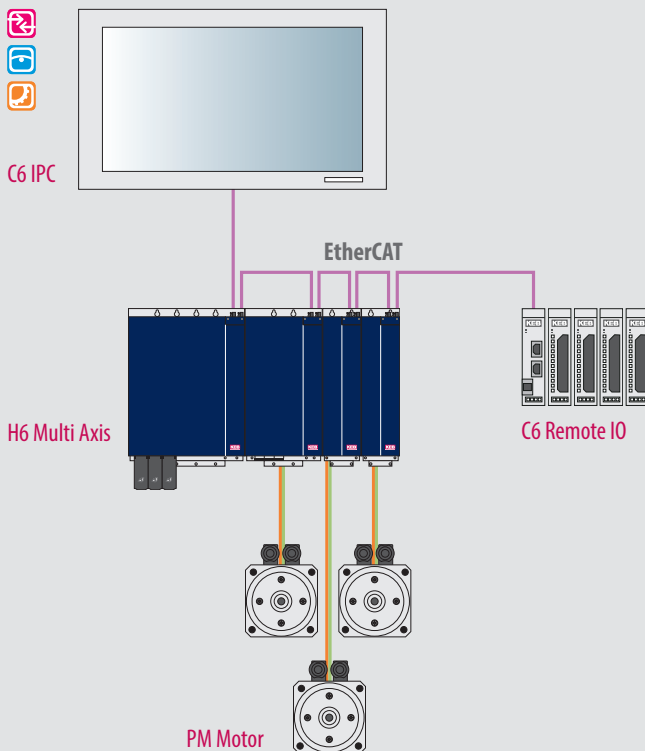

Powerful CNC coordinate transformations: The CNC program is translated into the true mechanical configuration in real-time for all points of the three-dimensional Cartesian axes. For companies who want to integrate their own robot movement in the machine project, we recommend the CNC Transformer library.

The advantage of seamless integration is the absence of a separate communication connection between robot control and IPC - which ultimately improves the machine performance and synchronization.

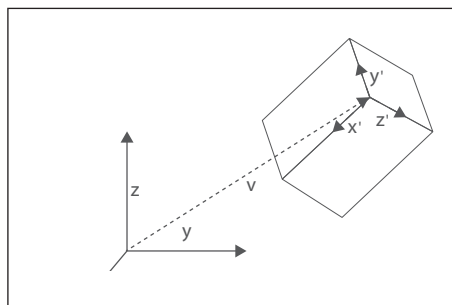

With CONTROL Runtime ADVANCED, the motion behind a movement are less relevant for writing the CNC program. Users can therefore concentrate more on developing the best overall mechanical and electronic solution for their application. The KEB solution supports the following movement:

- Five-axis transformation
- Two- and three-dimensional gantry systems with functions for cutting, tool correction and stationary axes
- Scara systems with two and three arms
- Parallel systems as bipod and tripod with vertical or rotary axes
- Robot movement with four and six axes

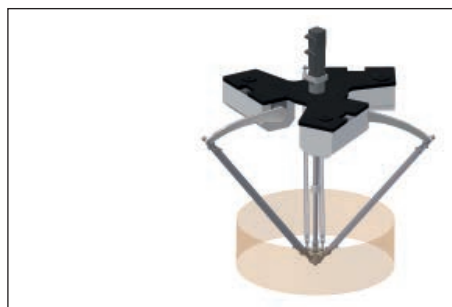

The five-axis transformation allows control of a kinematic consisting of the following elements: three linear XYZ spatial axes for positioning a toolhead freely in space, and two further axes for rotating and tilting the tool head.

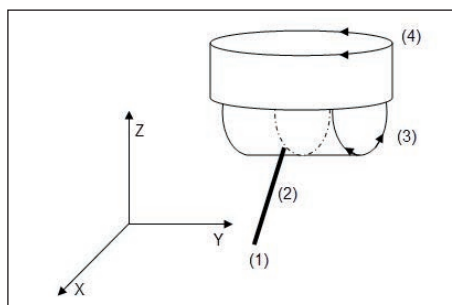

Transformation of an articulated arm robot with six rotary axes and degrees of freedom (DoF). The three orientation axes of the robot arm intersect at a single point, the wrist centre point.

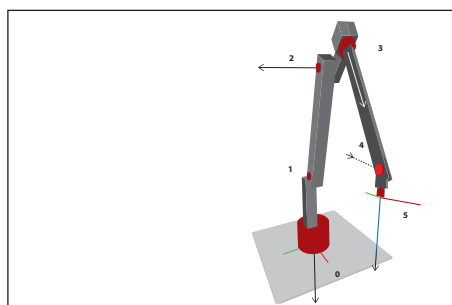

CONTROL RUNTIME

ADVANCED FUNCTIONALITY



INPUT OF EXTERNAL DATA

and files (TXT and DXF)

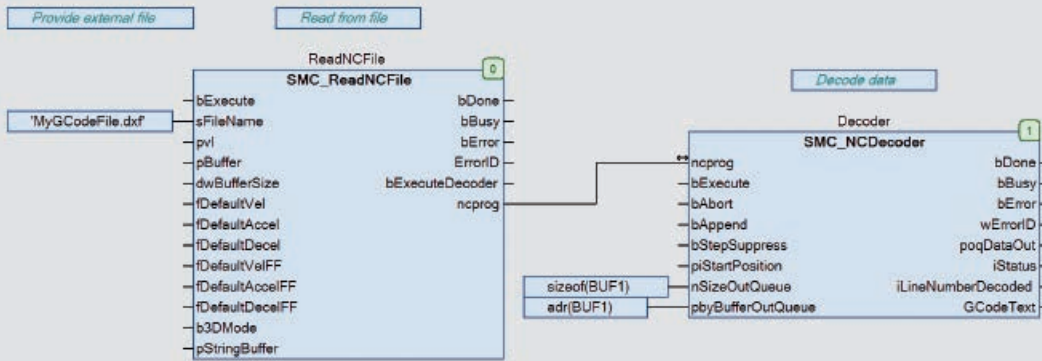

SAFETY FUNCTIONS

to prevent external faults

CNC EDITOR

With the CNC Editor to DIN 66025, COMBIVIS studio 6 offers a 3D-motion tool. With this, users can use movement profiles with trusted G-code workpiece files, and also TXT, DXF and CAD files for controlling movement profiles. The KEB software tool can treat the G-code path as part of the compiled code, or process a buffered external file which can in turn be edited in real time - a great advantage in longer processes.

Programming aids consist of a number of assistants for avoiding loops, for calculation of round or smooth paths, working with polynomials of the 3rd or 5th order, rotation speed limitation, 3D scaling, rotation and splitting.

The engineering approach of KEB makes the implementation of CNC tasks as simple as possible while retaining high flexibility because the individual modules can easily be exchanged.

INTERPOLATION

and profile generator

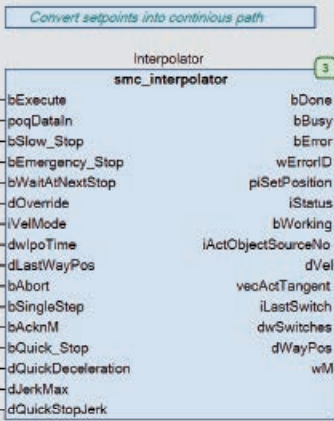

MOVEMENTS

in large numbers



DRIVE CONTROL

Drive position reference

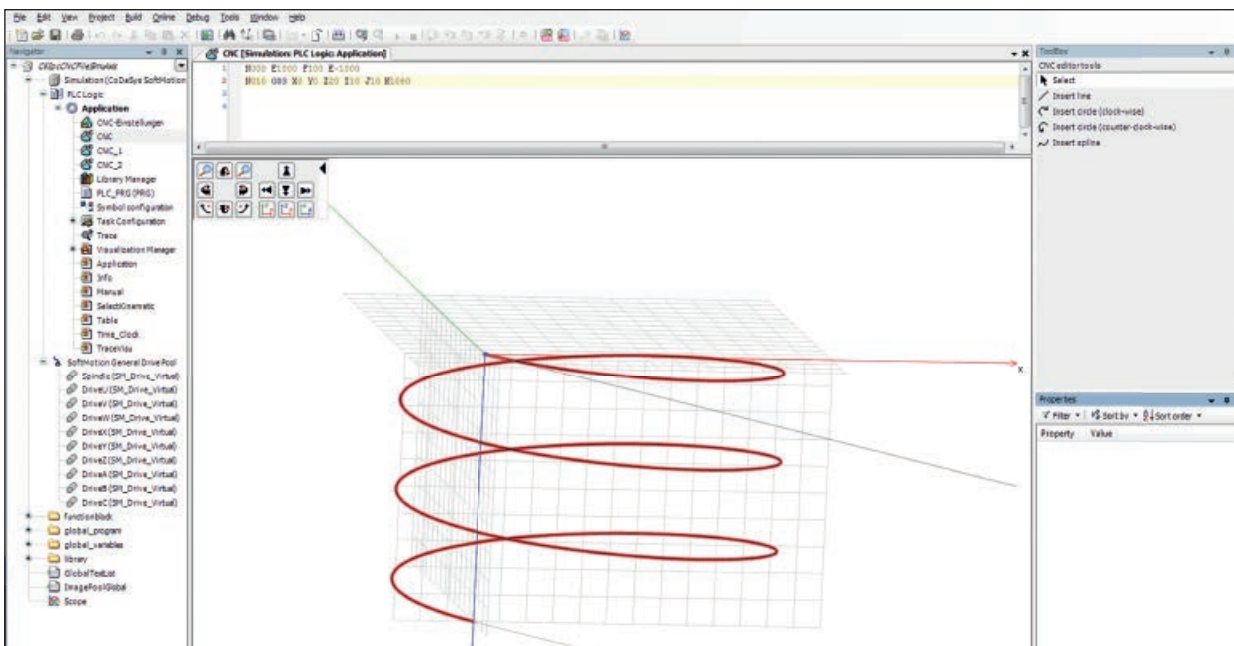
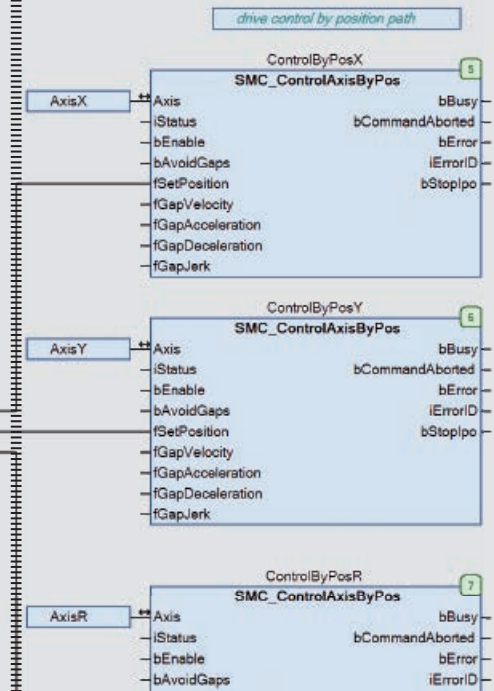

CONTROL RUNTIME

SIMPLIFIED CONFIGURATION OF ROBOT APPLICATIONS

KEB CONTROL Runtime ADVANCED enables the user to conveniently configure complex robot axis groups with an integrated editor. The user can select the desired kinematics, parameterize and connect with the physical robot axes. The robot function is processed with standardized function blocks according to PLCopen MotionControl Part 4

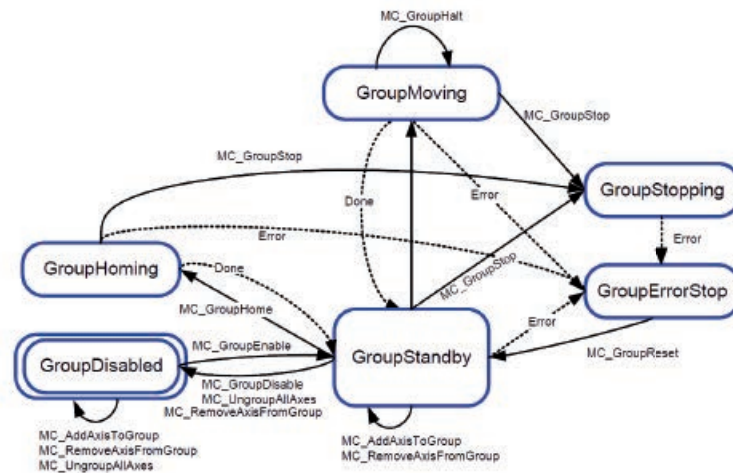

With CNC the exact observance of the path with the given speed is in the foreground. It is assumed that the machine can follow these guidelines, so that the resulting speeds, accelerations and moments are tolerated by the machine. For point-to-point (PTP) movements, path adherence is secondary. The movements in the axis space are defined by waypoints; between these points the movement is interpolated. The speed and acceleration limits of the axes are taken into account.

For continuous path movements (CP), the kinematics follows a programmed path. In contrast to the CNC, the speed, acceleration and jerk limits of the axes are taken into account. Under these conditions, the path is traversed as soon as possible. For PTP movements, the calculation of the movement takes only one cycle, so that movements can be planned or changed immediately. The calculation of CP movements is more complex and usually requires more than one cycle.

DYNAMIC TRACKING

The built-in tracking function allows movements to be programmed relative to a moving product coordinate system. The tracking ensures that the movement of the product is automatically superimposed with the movement relative to the product. In simple cases, the product is on a conveyor belt or rotary table and moves with it. But it is also possible that the product is moved by a second robot

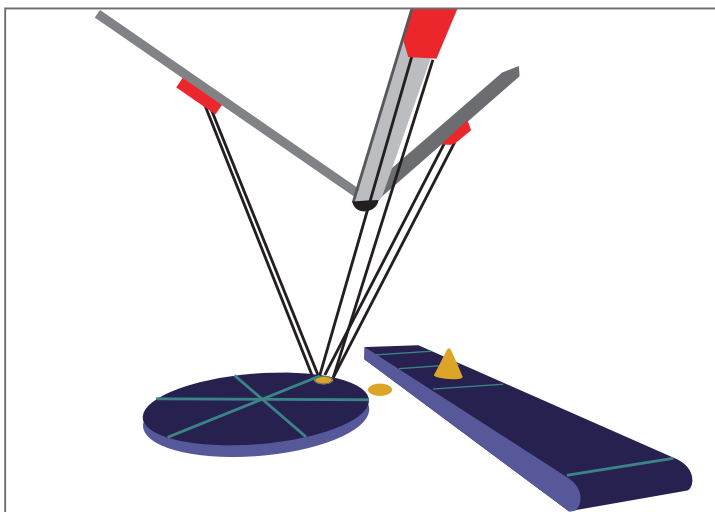

CONVENIENT PARAMETERIZATION OF AXIS GROUPS FOR PREDEFINED KINEMATICS IN A SEPARATE EDITOR

- Integrated motion planning with coordinate values for robot positions in different coordinate systems
- Function library with program blocks according to PLCopen Motion Part 4, such as: Eg MC_GroupEnable / Disable / Reset / ReadError, MC_MoveDirectAbsolute, MC_MoveDirectRelative, MC_GroupHalt, MC_GroupStop, MC_TrackConveyorBelt or MC_TrackRotaryTable
- Many supported kinematics with comfortable configuration, eg. Various portal robots (2/3/5 axes), bipod / tripod robots, scara robots
- Additional tool kinematics

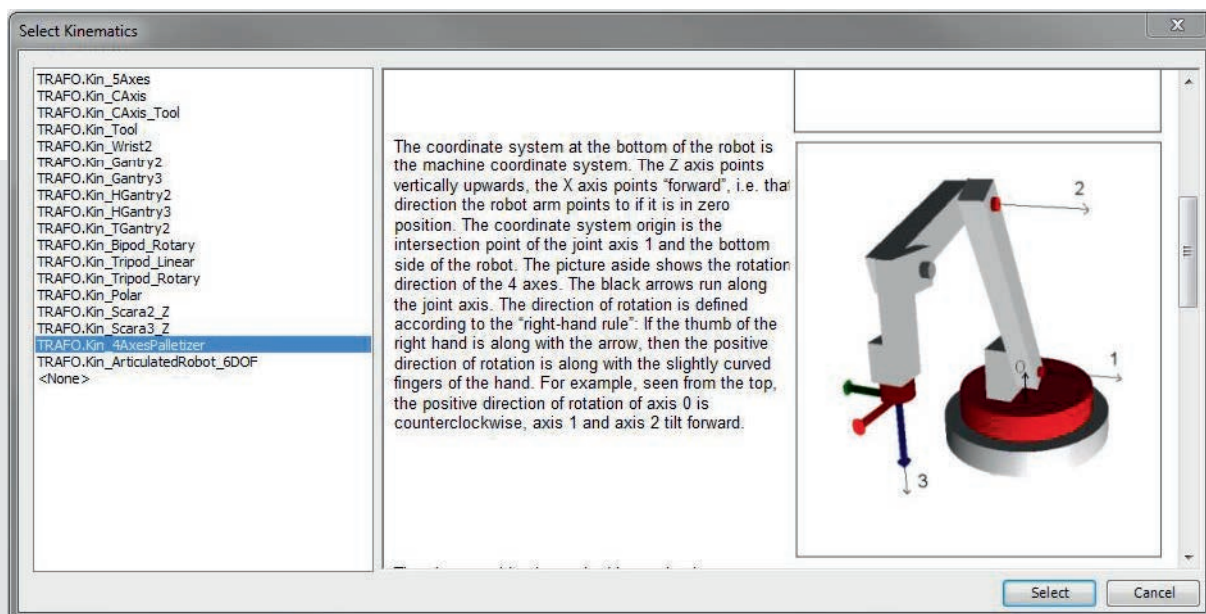

OVERVIEW LIBRARIES

APPLICATION

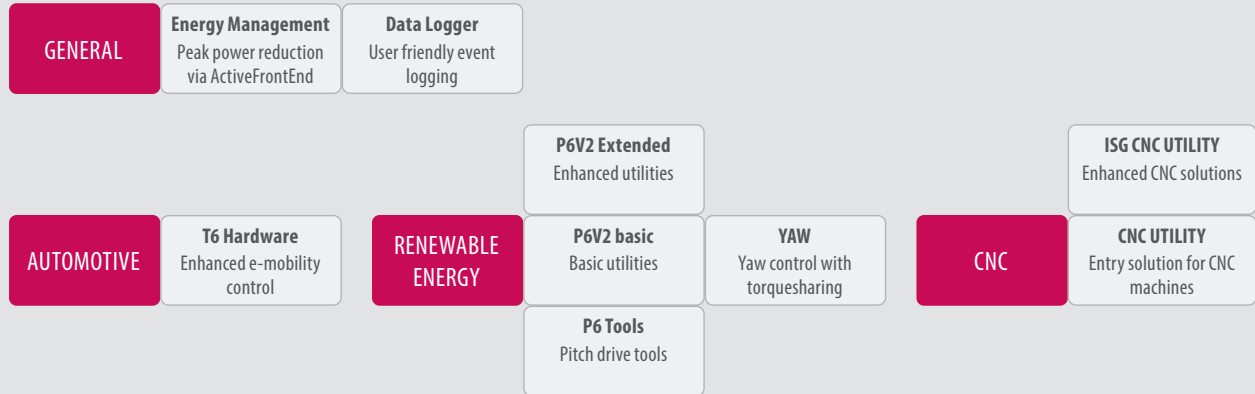

TOOLS

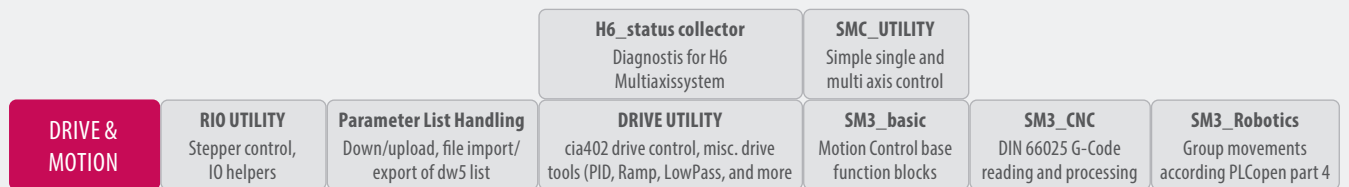

COM

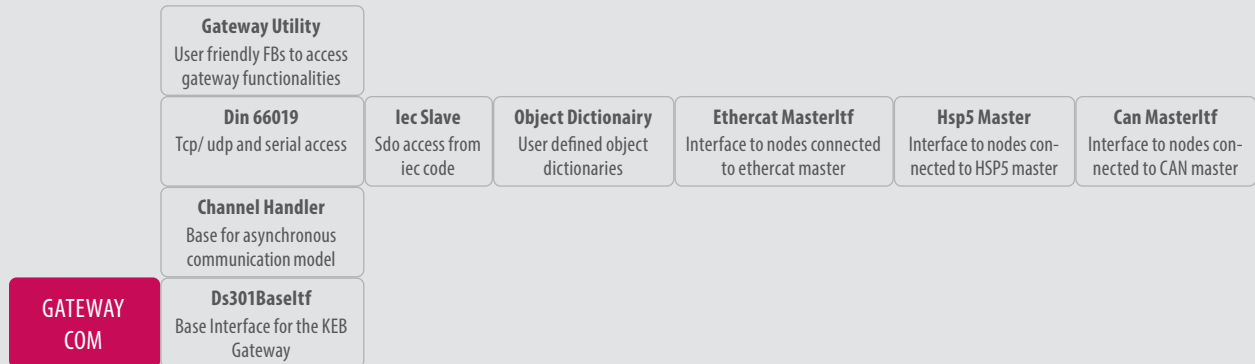

SYSTEM

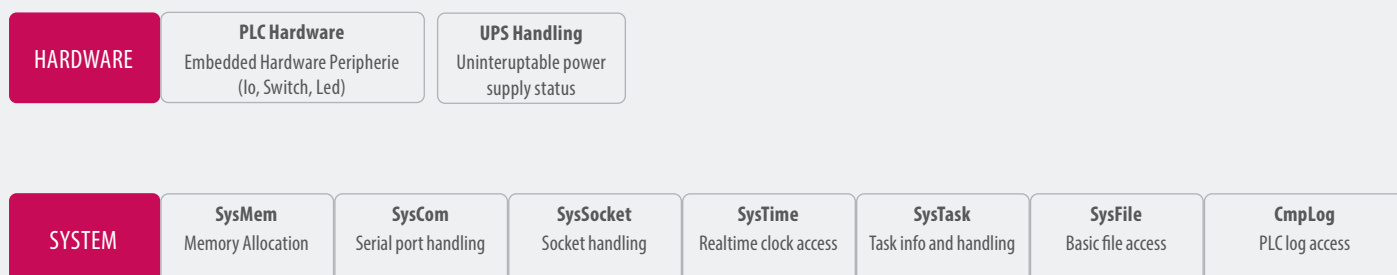

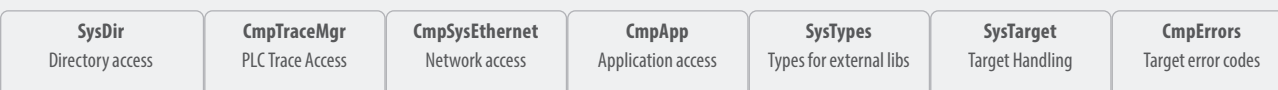
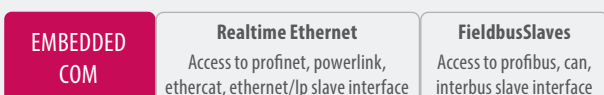
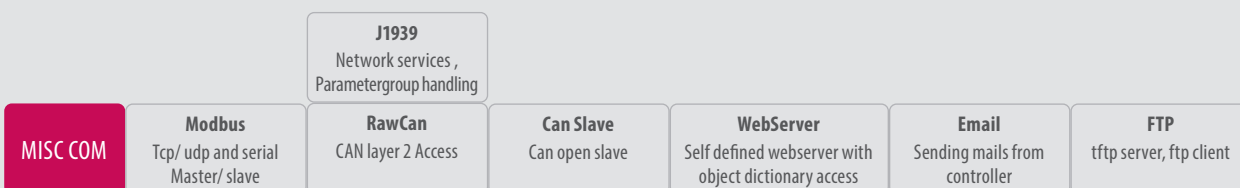
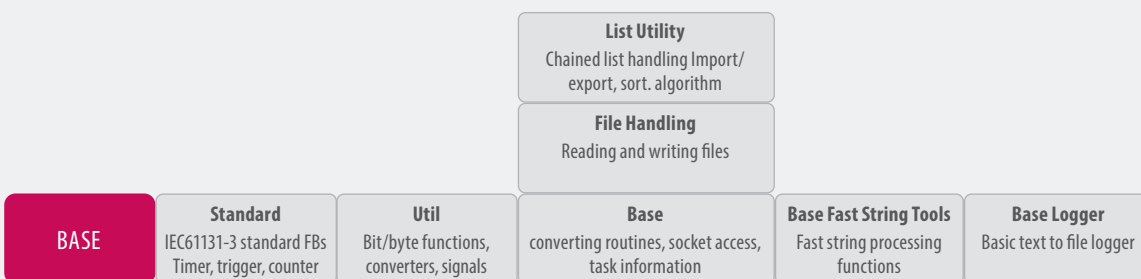

KEB RAWCAN

APPLICATION:

The **KEB_RawCan Library** allows an easy access to CAN Layer 2. This can be used for simple applications or for complex protocol developments.

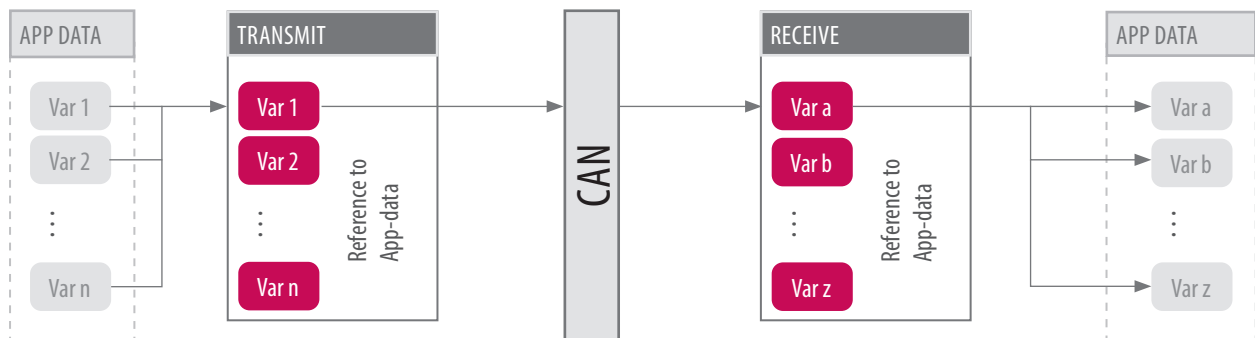

APPLICATION GROUP

- Application programming
- Communication and data processing
- CAN protocol development

REQUIREMENTS

- j1939 license installed on runtime



HIGHLIGHTS

- Direct links from CAN data to user data by the KEB_MappingManager
- Automatic datatype detection
- Simple function block design and usage

APPLICATION:

The **KEB_j1939 Library** allows the user to communication via the SEA J1939 CAN protocol. The modular design of the software allows the user to define what parameter groups shall be send or received by the j1939 stack.

PARAMETER GROUPS:

DM1, DM2, DM3, DM4, TD, PropA, PropB, CCVS, EEC1, EEC2, ET1, IC1, CustomPg8Byte, CustomPgNByte

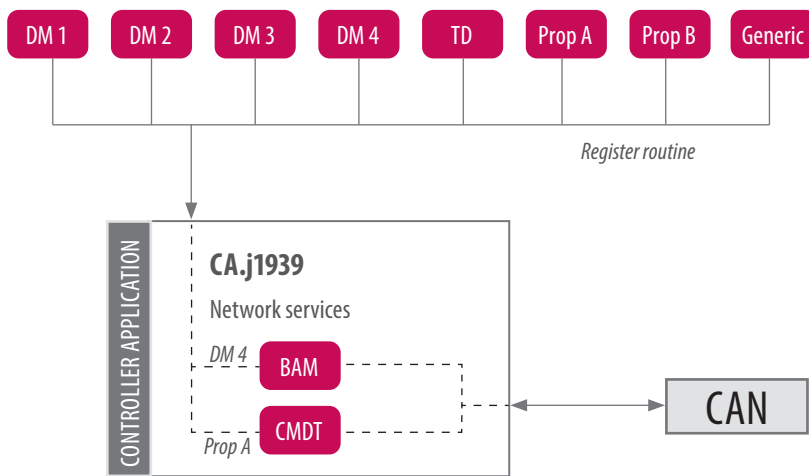

--- Automatic routing to correct network services

APPLICATION GROUP

- Application programming
- Communication and data processing

REQUIREMENTS

- j1939 license installed on runtime



HIGHLIGHTS

- Modular and extenable CA functionality
- DM1-4 with included error history function
- Transmit of up to 1785 Bytes in one parameter group
- Automatic detection of telegram size and the necessary network services CMDT/BAM

KEB_SMC_UTILITY

APPLICATION:

The **KEB_SMC_UTILITY** includes simple function block for the implementation of axis movement jobs. The axis control FB's get linked to the drive hardware and allows access to all single or multi axis functions.

SINGLE AXIS MODES:

VELOCITY, POSITIONING_ABSOLUTE, POSITIONING_RELATIVE, SET_POSITION, HOMING

MULTI AXIS MODES:

PHASING, GEARING, CAMING

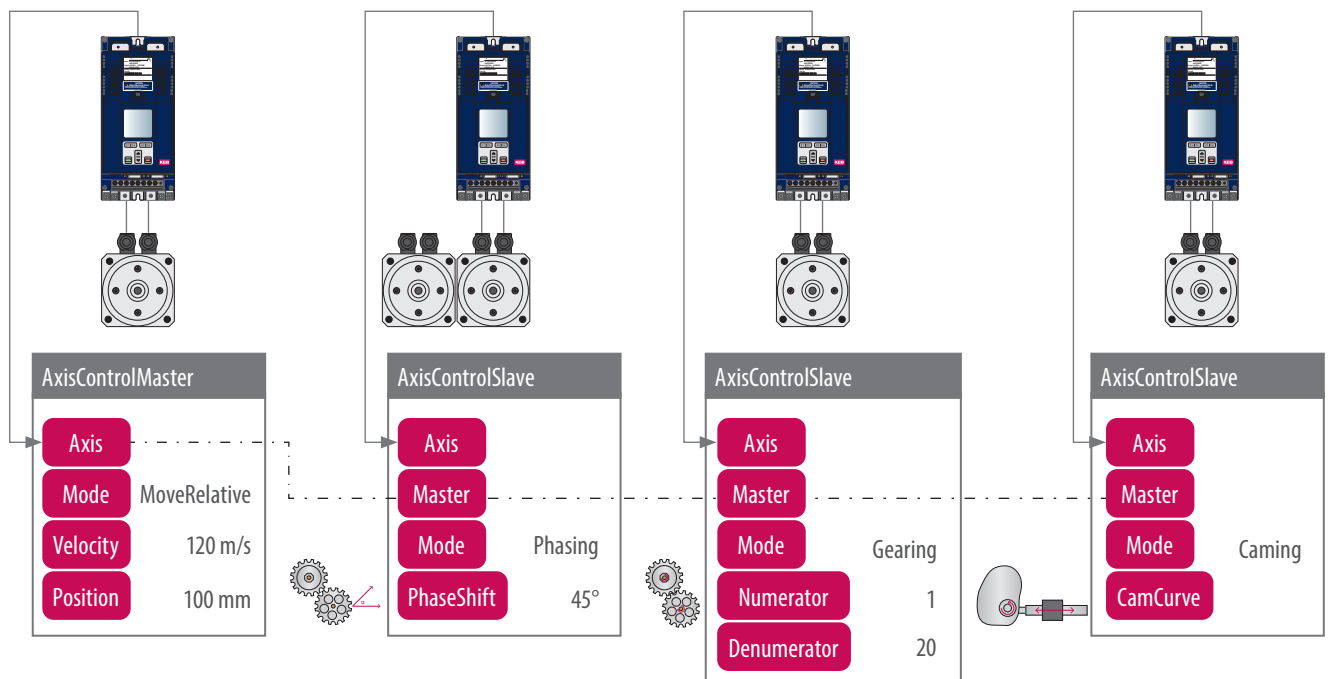

APPLICATION GROUP

- Application programming
- Motion design

REQUIREMENTS

- Included in COMBIVIS studio 6
-   Control PRO



HIGHLIGHTS

- Easy startup of single- and multi-axis applications
- Low programming effort for complex movements jobs

APPLICATION:

Allows the user the creation of a doubly linked list. This can be used to handle complex data types or function blocks in form of a list.

The list includes functions like add, delete, search, compare or sort of list objects. It also offers the possibility to import or export the list into the file system.

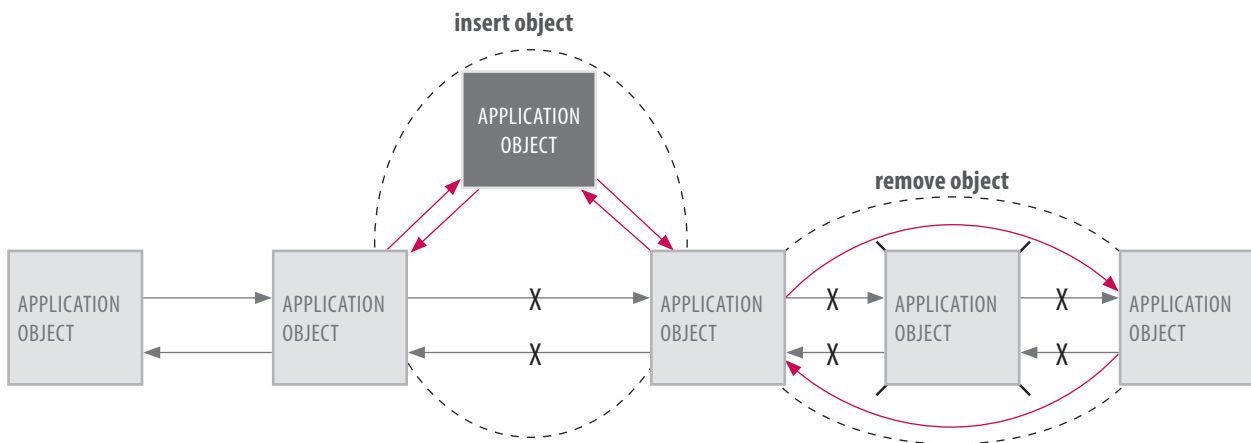

APPLICATION GROUP

- Application programming
- Creation of databases
- Simple and structured use of huge and complex data in any file format

REQUIREMENTS

- Included in COMBIVIS studio 6
- Control BASIC



HIGHLIGHTS

- Efficient sort algorithm
- Datatype independent
- Possibility of dynamic extension of the list
- Import and export function

KEB DRIVE_UTILITY

APPLICATION:

The **KEB_Drive_UTILITY** offers tools and function blocks for general drive handling. Drives can be handled by the KEB_CIA402-Control-FB in all modes defined inside the CIA 402. Additional FB's allow functions like torque sharing or angle synchronous movement. Also different controller, filter, parameter download or Ramp FB's are part of the tools.

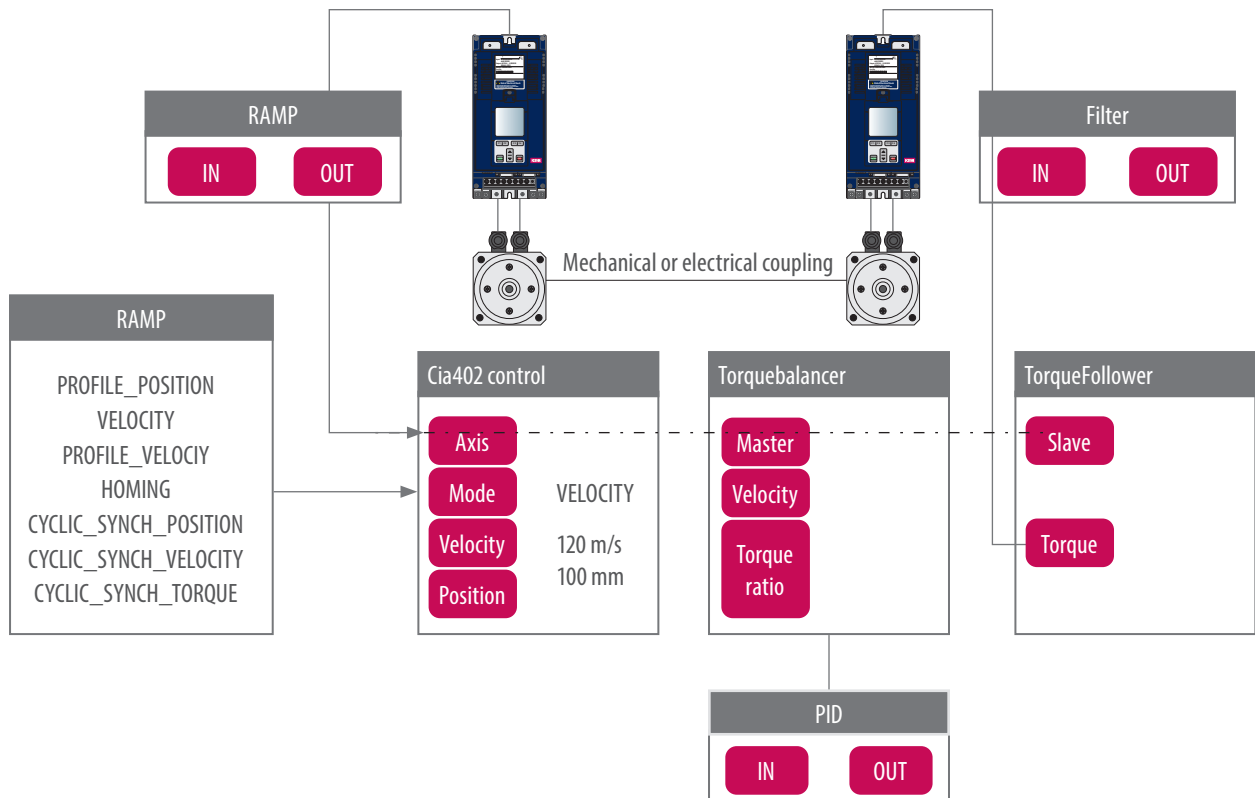

APPLICATION GROUP

- BASIC drive handling regarding CIA 402
- Flexible movement and controlling jobs

REQUIREMENTS

- Included in COMBIVIS studio 6
-  Control BASIC



HIGHLIGHTS

- Universal Cia402 drive handling
- Huge drive toolbox

APPLICATION:

The **KEB_Gateway_Utility** manages all asynchronous communication for all possible communication interfaces of the PLC. It allows the user a direct drive access with COMBIVIS and its startup wizards via the Ethernet port of the PLC. It also gives the possibility to tunnel the asynchronous commands from one fieldbus into a sub fieldbus (e.g.: from ProfiNet into Ethercat).

INTERFACES:

Ethernet, Serial, Ethercat, Can open, ProfiNet, Interbus, Powerlink, EthernetIP, HSP5, Din66019

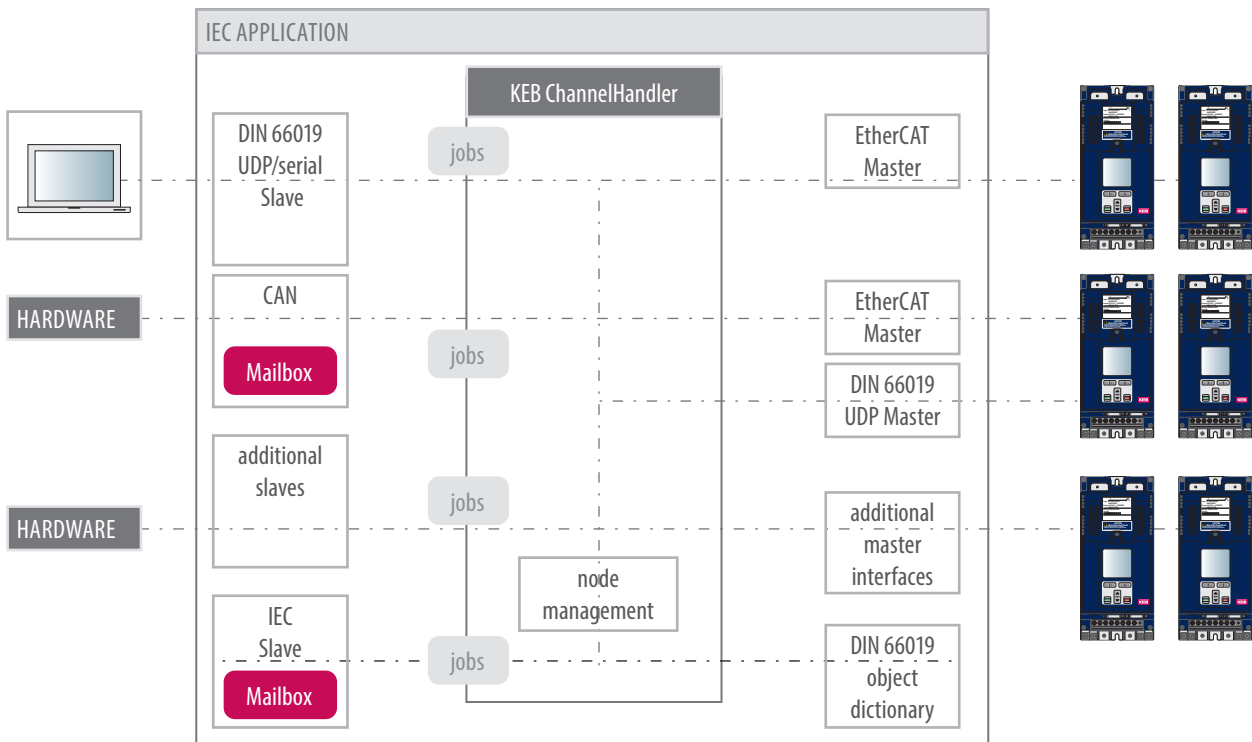

APPLICATION GROUP

- Startup and service
- Asynchronous communication

REQUIREMENTS

- Included in COMBIVIS studio 6
- Control BASIC



HIGHLIGHTS

- Universal communication gateway
- Standard function of the C6 controller

KEB DATALOGGING

APPLICATION:

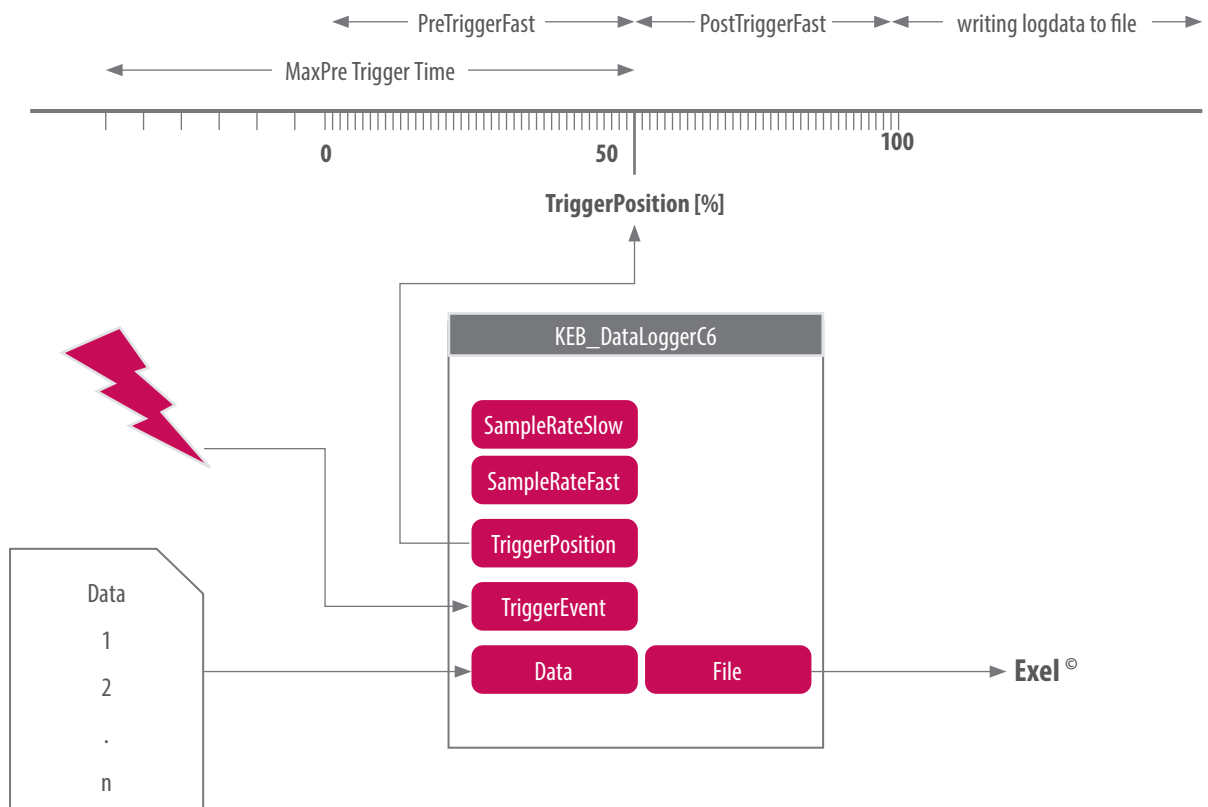

PLC variables of different data types can be logged cycle accurate with microsecond time stamp. The logger additionally enables the time range to record an event trigger in two temporal resolutions. Thus the amount of data for longer recordings can be reduced and at the same time the important area around an event can be recorded exactly. The data is automatically saved in a file ring memory.



APPLICATION GROUP

- Data and event logging
- Diagnosis

REQUIREMENTS

-   Control BASIC
- Datalogging library (demo pre-installed)



HIGHLIGHTS

- Flexible sampling settings
- Accurate plug&play event diagnosis

APPLICATION:

The library enables the server-client data exchange via Ethernet or serial interface. The diagnostic output can be used to quickly detect errors during configuration or data transmission.

Modbus TCP/ UDP / RTU client and server.

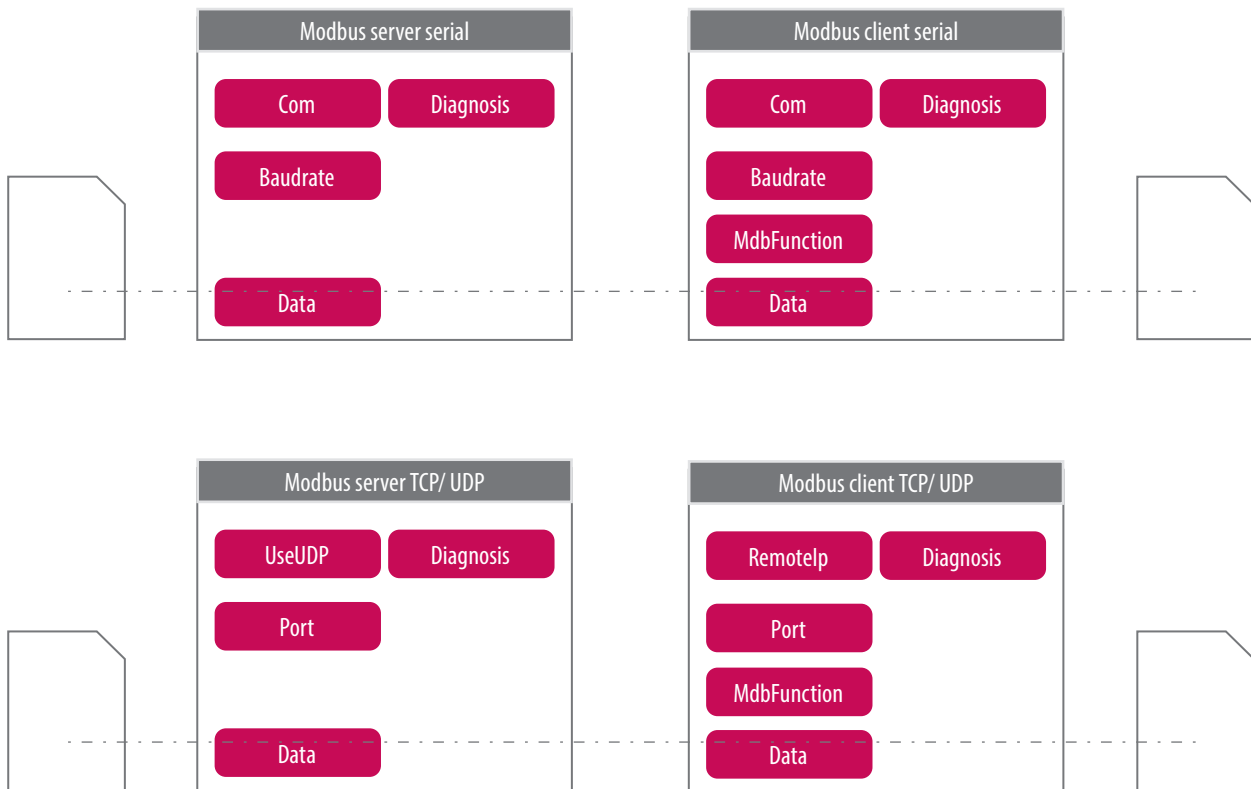

APPLICATION GROUP

- Applicators, M2M communication

REQUIREMENTS

- Included in COMBIVIS studio 6
- Control BASIC



HIGHLIGHTS

- Universal M2M communication
- Simple integration via IEC function blocks

APPLICATION:

The library supports the commissioning of KEB Stepper and BLDC Remote-IO-Drives by a FB with the most important settings and the AutoTune function. In connection with the KEB_Drive_Utility the drives can be operated according to the Cia402 standard.

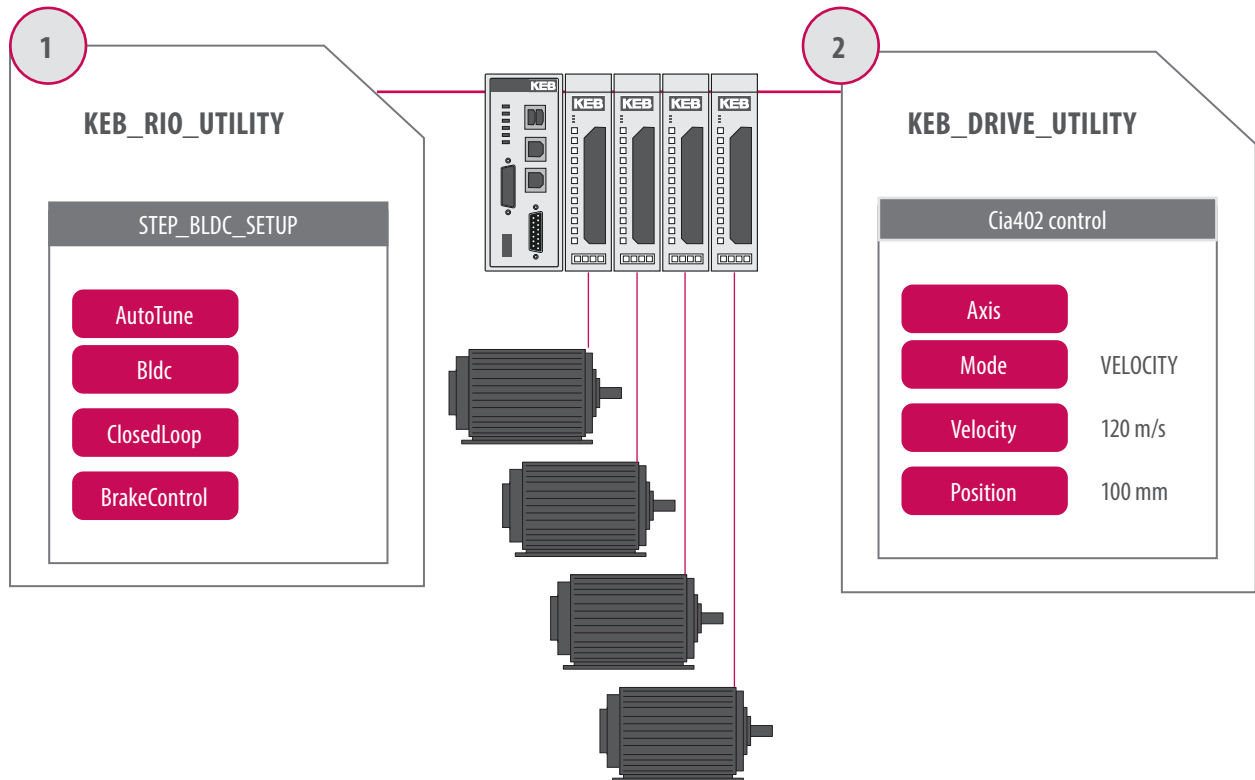

APPLICATION GROUP

- Stepper/BLDC drive commissioning

REQUIREMENTS

- Included in COMBIVIS studio 6
-  **B** Control BASIC with Stepper/BLDC Drive Module



HIGHLIGHTS

- Simple configuration by setting FB inputs

APPLICATION:

The **KEB Yaw_Library** provides a collection of modules for programming the yaw drives of a wind turbine. This considerably reduces the programming effort for such an application. Special algorithms for torque distribution over several motors minimize wear and mechanical stress on the drive train and tower of the wind turbine.

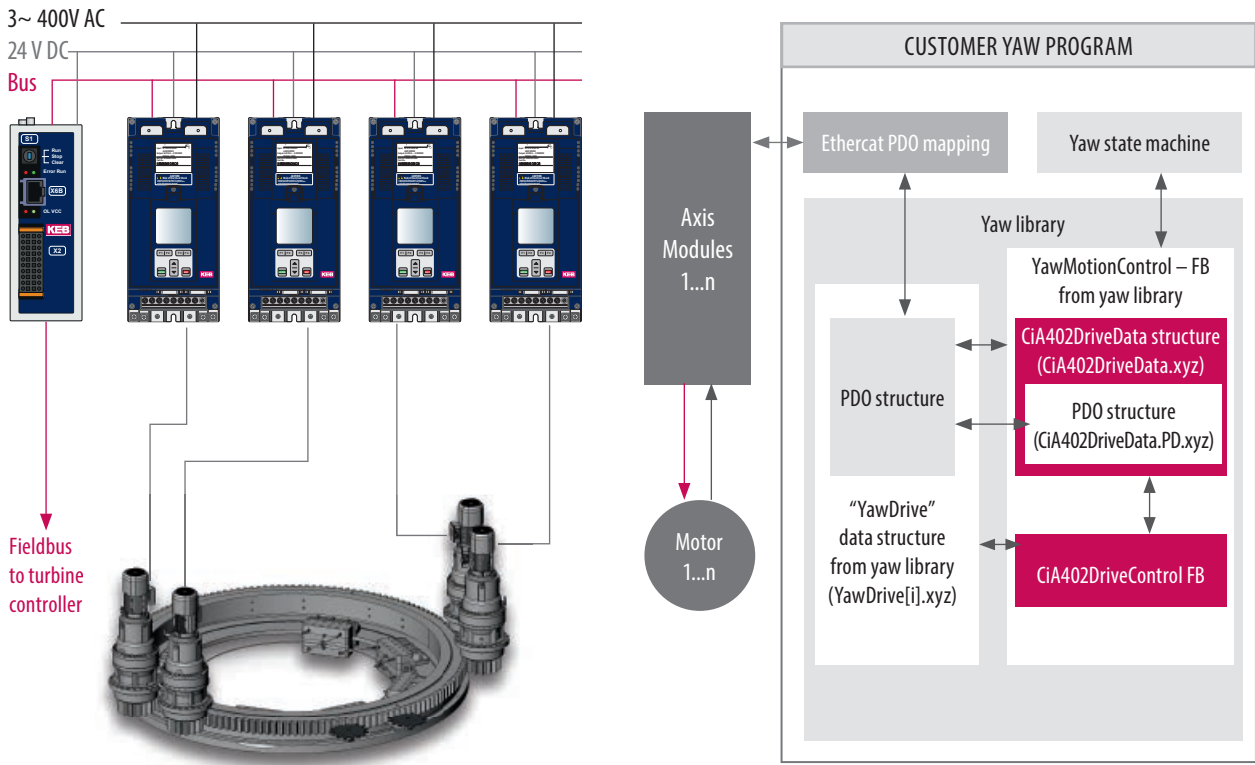

APPLICATION GROUP

- Programming of a multi-motor system for yaw adjustment
- of a wind power plant

REQUIREMENTS

- KEB control with installed license file



HIGHLIGHTS

- Drive control for the gentle movement of the wind turbine nacelle
- Special control method for uniform torque distribution to all motors
- Monitoring of gears and motor cables
- Error history and 56-channel data logger for recording any program variable
- Visualization of all relevant functions and drive data

KEB ENERGY_MANAGEMENT

APPLICATION:

The **KEB Energy_Management_Library** is used to control and monitor a KEB Active Front End (AFE) inverter in combination with an energy storage device (ultra capacitors) and electric drives or other consumers. Such a system allows the control and limitation of the power consumed from the mains or the power fed back into the mains. Power peaks during motor or generator operation of the drives are completely covered by the energy storage unit.

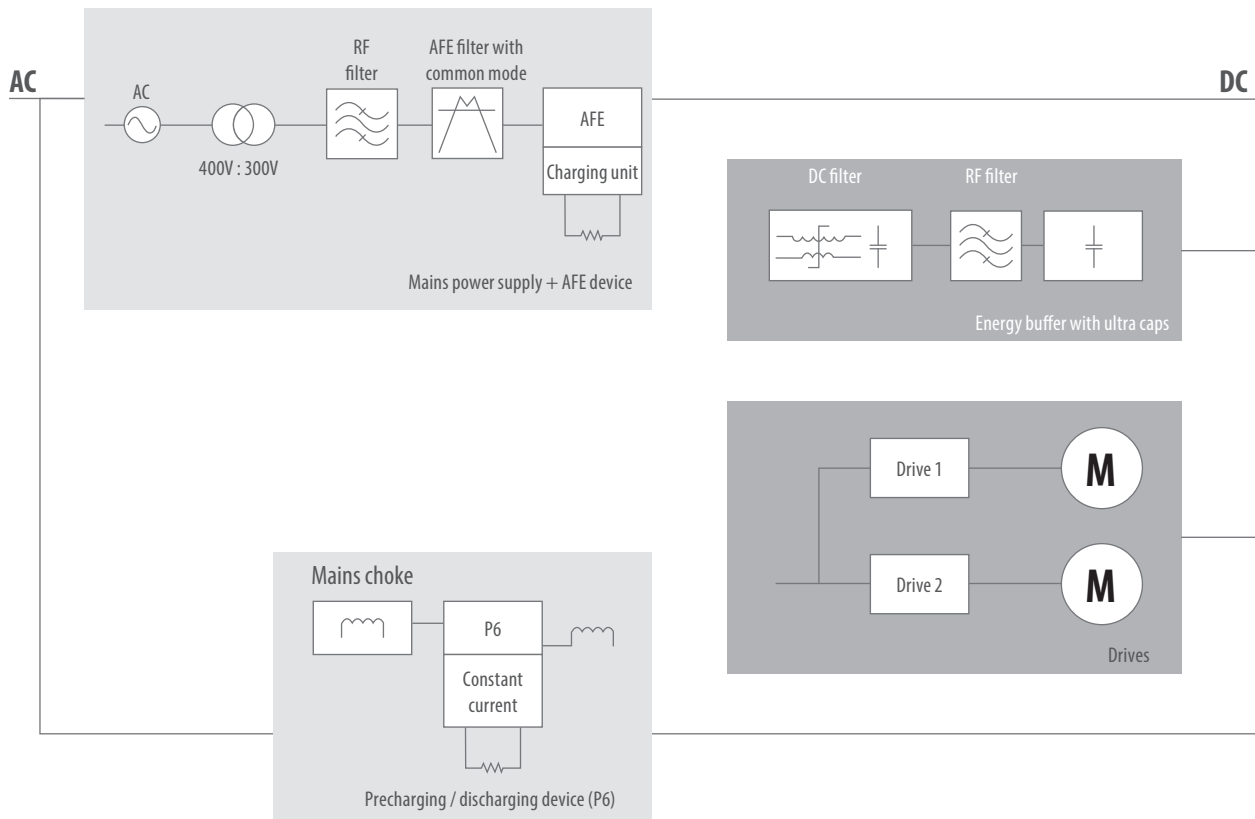

APPLICATION GROUP

- Energy management systems with storage; limitation from mains power peaks

REQUIREMENTS

- KEB control with installed license file



HIGHLIGHTS

- Control of the AFE inverter with limitation of mains power and mains current
- Control of charge / discharge of the energy storage device
- Control of the mains power factor ($\cos \varphi$)
- 56 channel data logger for recording any program variables
- Visualization of all relevant variables (voltage, current, power, energy)

APPLICATION:

The **KEB P6_Basic_Library** forms the basis for programming the pitch inverter KEB COMBIVERT P6. It allows easy use of basic P6 functions using the integrated IEC 61131 controller and significantly reduces programming effort.

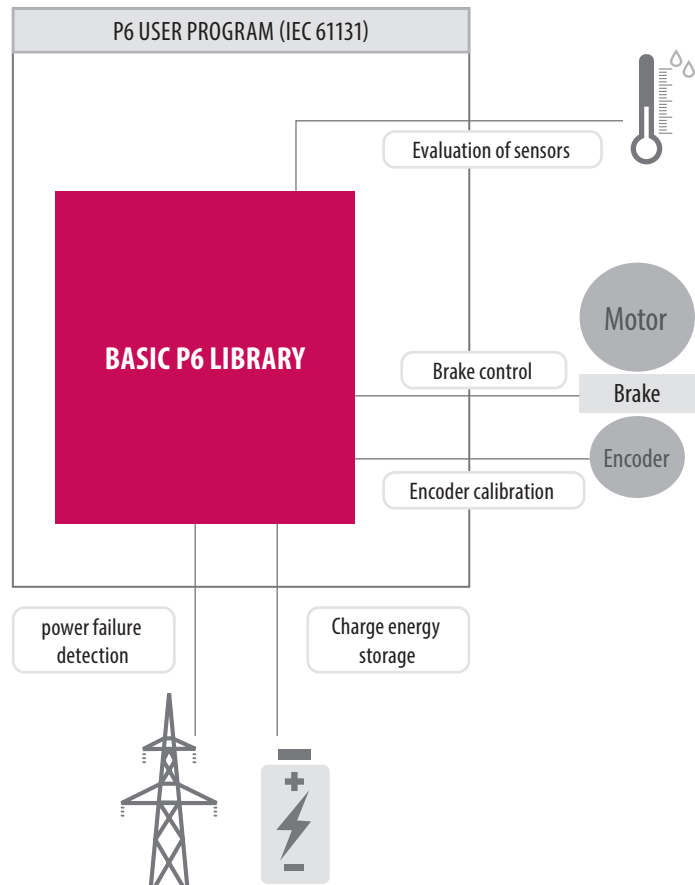

APPLICATION GROUP

- Application programming with P6 inverters
 - Pitch angle adjustment of wind turbines
 - Special applications e.g. in very cold environments or with the use of energy storage devices such as ultra capacitors

REQUIREMENTS

- KEB P6 inverter



HIGHLIGHTS

- Startup and communication monitoring between power section, control section and P6-PLC
- Cyclic reading and writing of all relevant drive parameters
- Control and monitoring of a 24 V brake or a high-voltage brake
- Encoder calibration and monitoring
- Control and monitoring of the built-in charging circuit for energy storage devices
- Evaluation of temperature, humidity and acceleration sensors
- Monitoring and acknowledgement of the certified safety drive
- Visualization templates for all function blocks

KEB P6V2_EXTENDED

APPLICATION:

The **KEB P6_ExtendedPitch_Library** provides a collection of blocks for programming a pitch application based on the KEB COMBIVERT P6 inverter. This considerably reduces the programming effort for such an application.

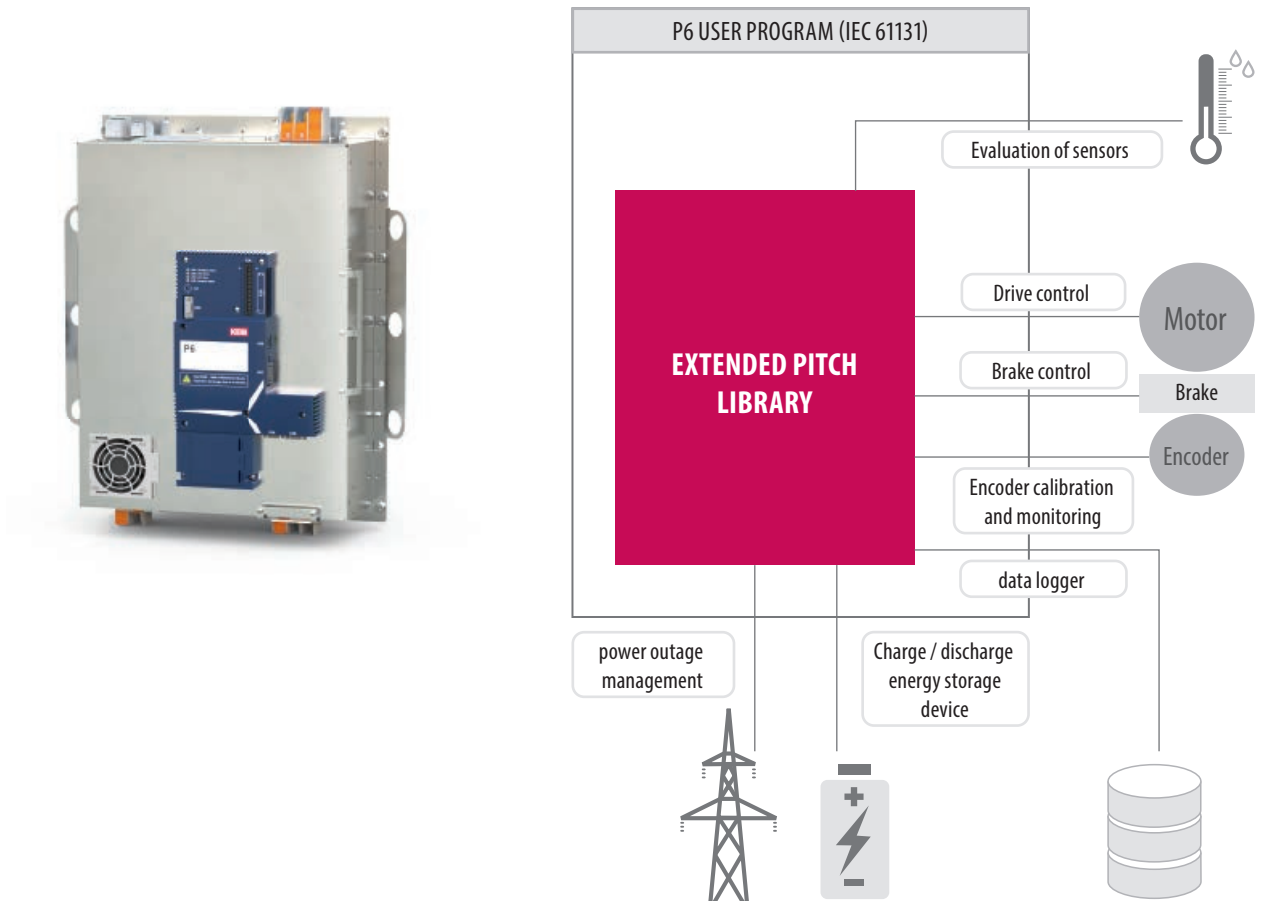

APPLICATION GROUP

- Programming the pitch angle adjustment of wind turbines with P6 converters

REQUIREMENTS

- KEB P6 inverter with installed license file



HIGHLIGHTS

- Contains all functions that are already available in the KEB P6_Basic_Library
- Additional modules for
 - Drive control (speed controlled, position controlled)
 - Motor and power failure monitoring
 - Charging and discharging ultra capacitors
 - 42-channel data logger and error history

APPLICATION:

The **KEB_PLM_UTILITY** contains basic function blocks based on the PackML State Machine. By extending this function blocks, the library allows the user to create a modular machine application based on PackML standards. This enables the user a fast and easy way to integrate jobs (machine processes) in his application and call them.

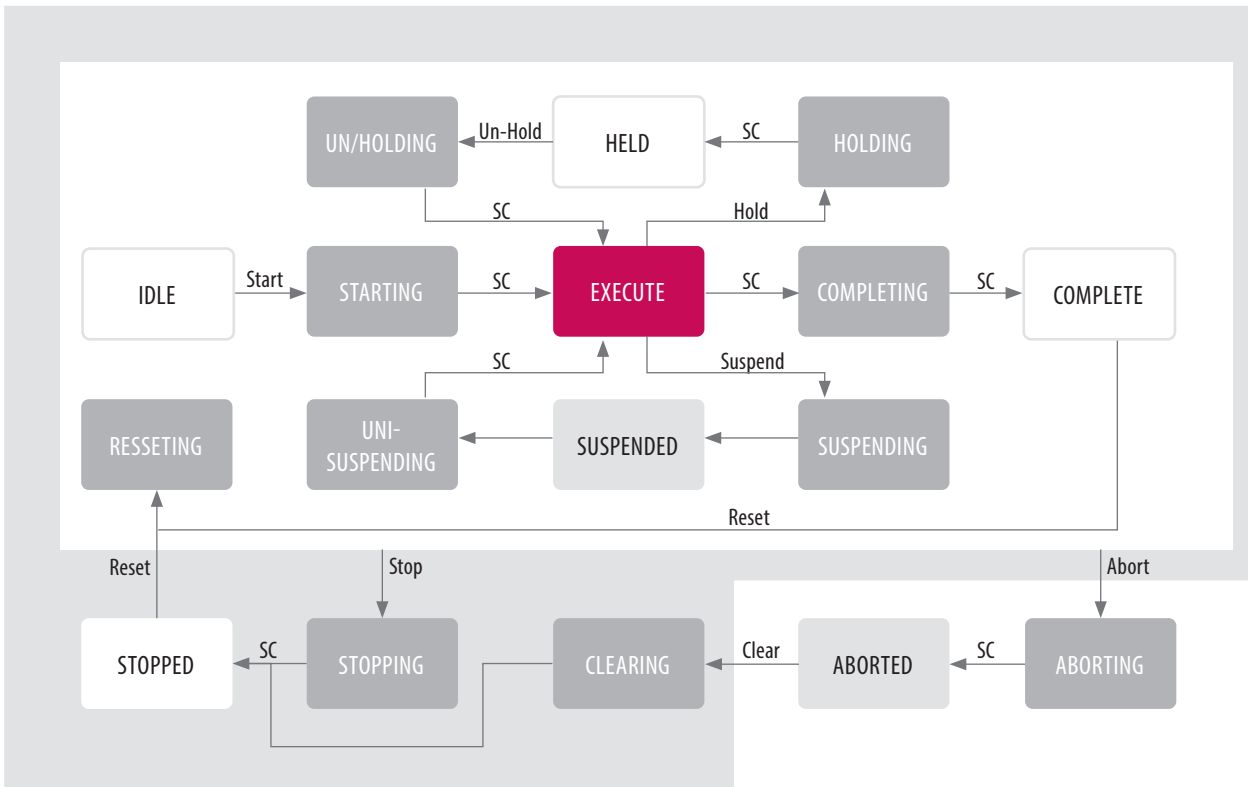

APPLICATION GROUP

- Modular PackML based application programming

REQUIREMENTS

- Control BASIC



HIGHLIGHTS

- Fast integration of PackML State Machine in machine modules
- Modular and future-proof software architecture thanks to standardized base function blocks

KEB BASE

APPLICATION:

This library contains function blocks for basis communication function via Ethernet by socket handling, DNS and NTP. The KEB_ MappingManager supports the user map the communicated data to application variables of any type. Several monitoring tools for example TaskInfo and SysTimeDiff allows the user to optimize the PLC application in term of cycletime.

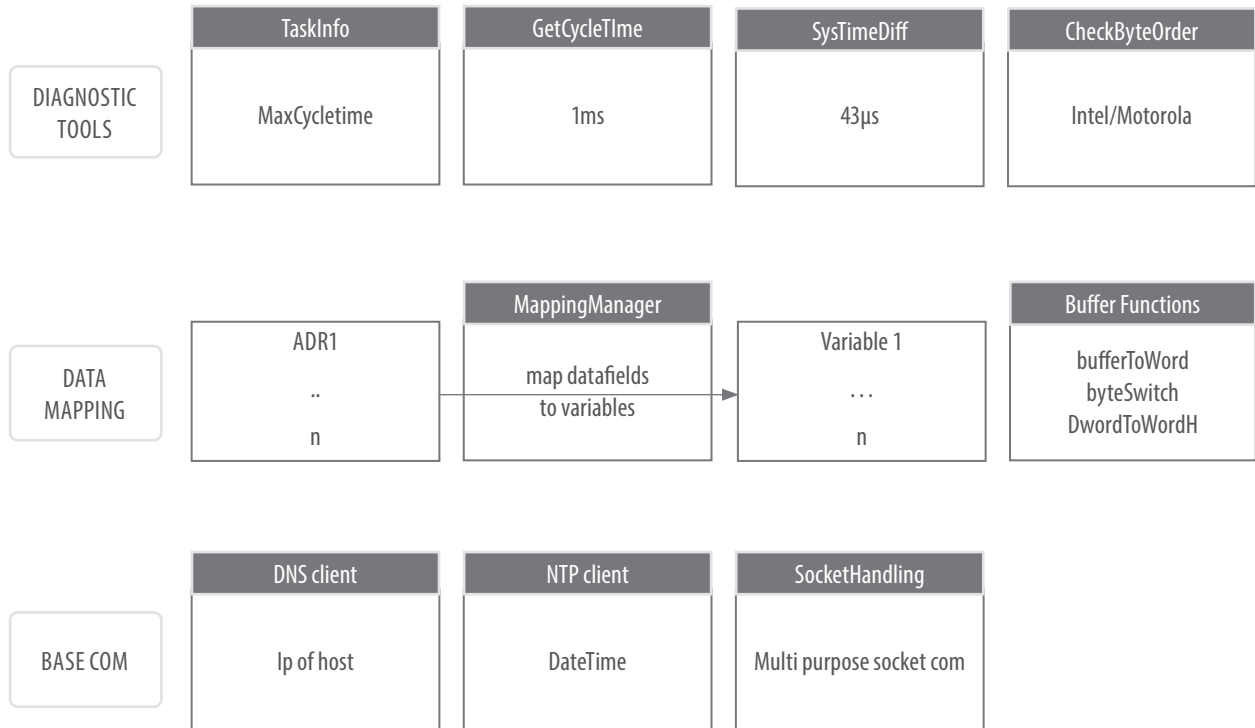

APPLICATION GROUP

- Communication and data management

REQUIREMENTS

-  Control BASIC



HIGHLIGHTS

- Socket communication, Data management and Cycle time diagnosis tools

APPLICATION:

The library allows sending emails with attachments from the IEC61131 application.

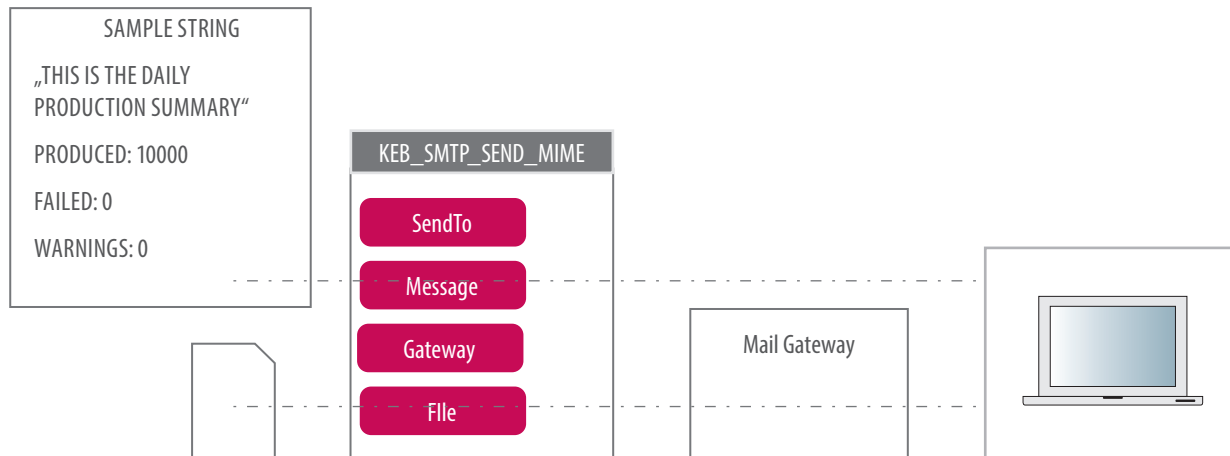

APPLICATION GROUP

- Communication and data processing

REQUIREMENTS

- Control BASIC



HIGHLIGHTS

- Status reports, messages and log files can be processed centrally without access to the PLC

KEB FTP

APPLICATION:

The library allows sending and receiving files from the IEC61131 application.

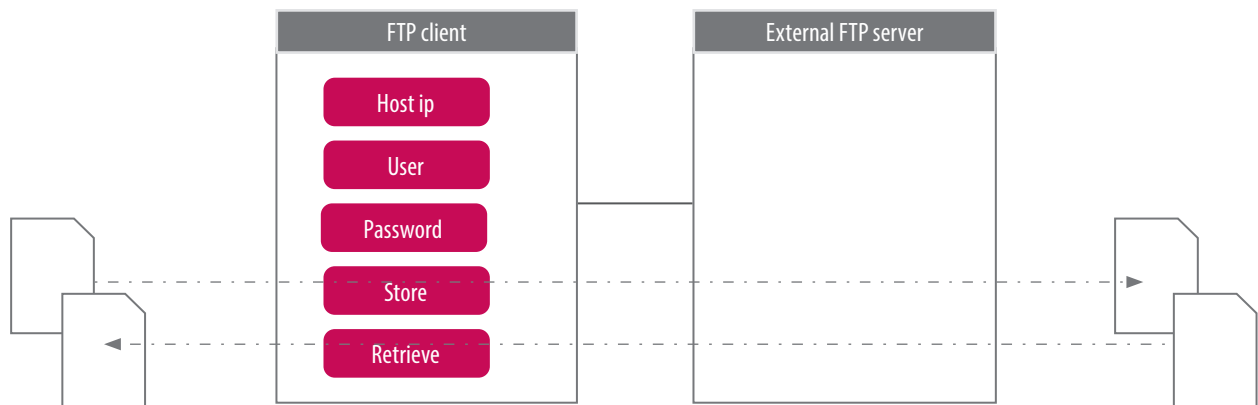

APPLICATION GROUP

- Communication and data processing

REQUIREMENTS

-  **B** Control BASIC



HIGHLIGHTS

- Simple possibility to exchange files

APPLICATION:

The **KEB_ISG_CncUtility** offers the user an easy handling of CNC applications. It starts from easy motion controls without cinematic transformations and ends at multiple channels with complex cinematic.

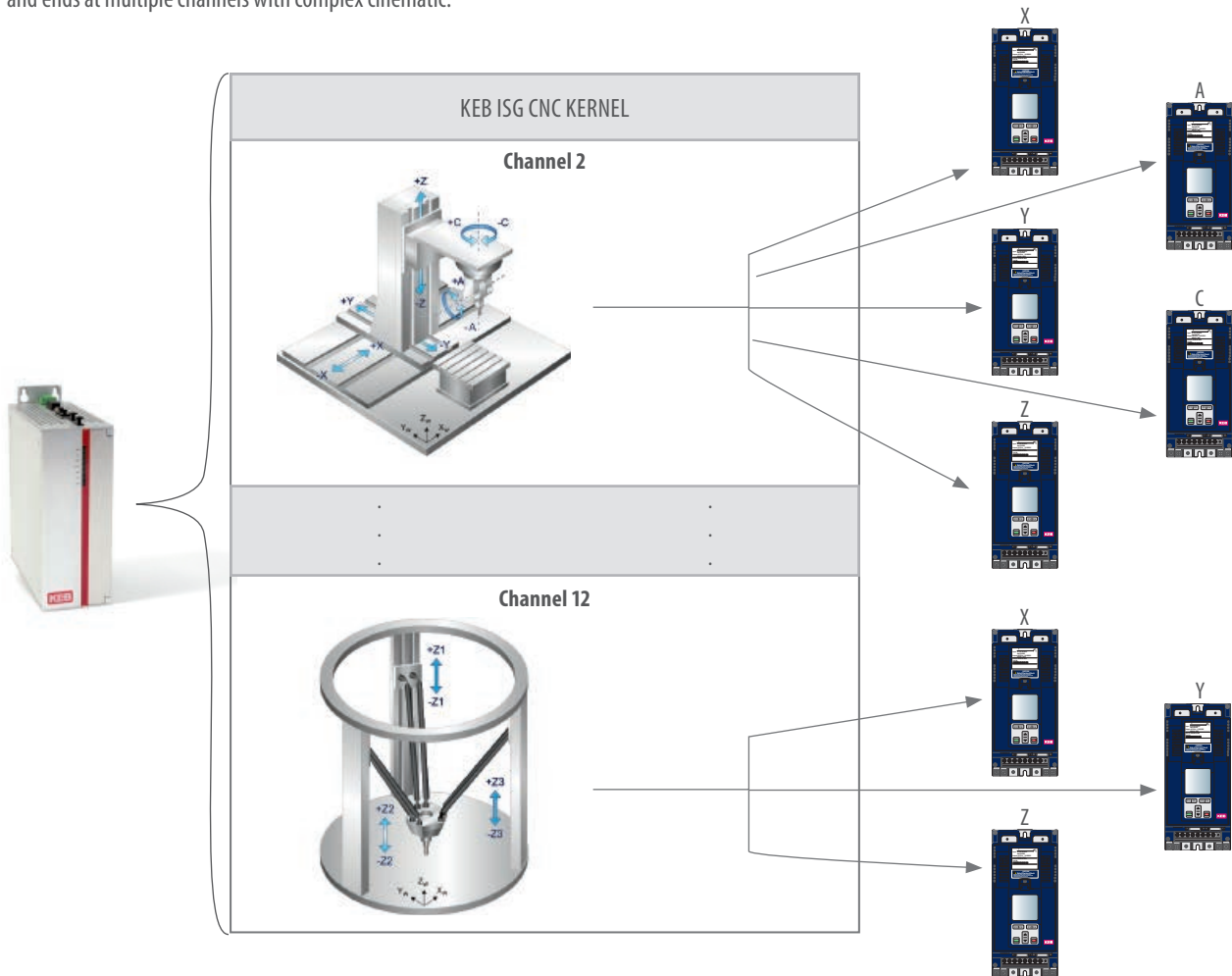

APPLICATION GROUP

- Application programming CNC

REQUIREMENTS

- KEB CNC Package
- Control BASIC



HIGHLIGHTS

- Easy implementation in PLC project
- Integrated Toolhandling and error history
- Up to 12 Channels and 64 Axis

KEB TEMPERATURCONTROLLER

APPLICATION:

This library allows the user to control the temperature of one or several heating and cooling zones. The auto tuning function saves the user time by skipping the manual setup of the controller. It heats up the zone once and automatically detects all parameters needed for a smooth control loop.

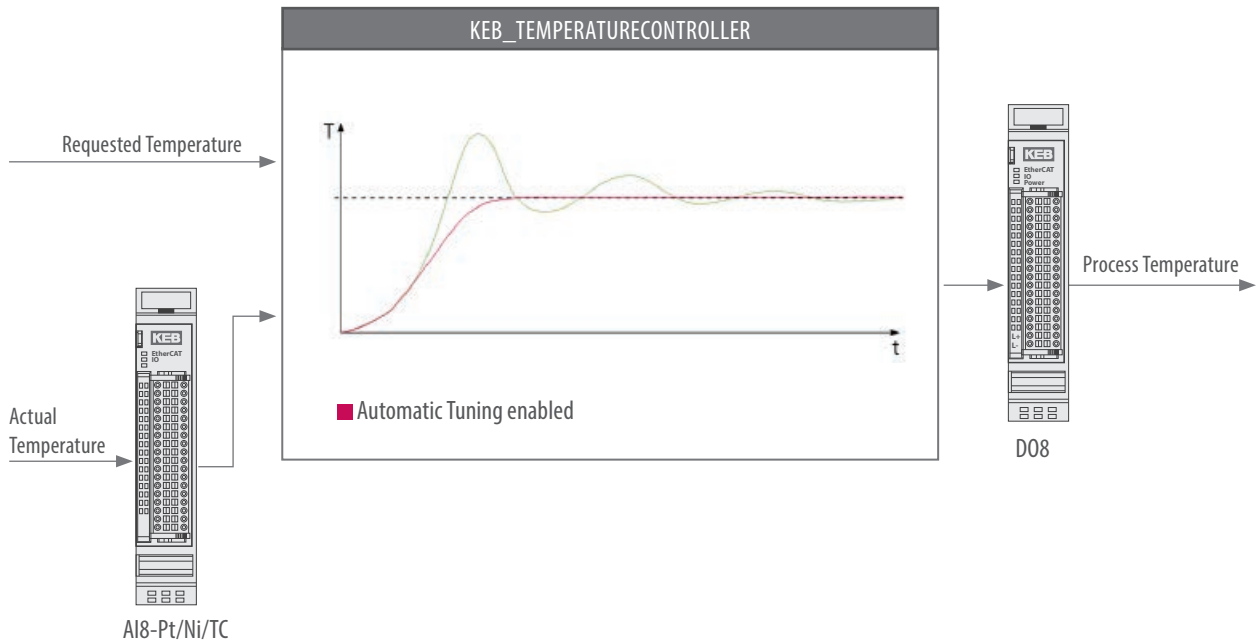

APPLICATION GROUP

- Extrusion machines
- Curing oven Tempering furnace

REQUIREMENTS

-  Control BASIC



HIGHLIGHTS

- Automatic tuning of heating zones
- High precision temperature control
- Limited user inputs
- Dynamic warn-, alarm- and error-temperature thresholds

APPLICATION:

This library is designed for pressure control of servo pumps in highly dynamic processes like in plastic injection machineries. By running an auto tuning function, the function block generates up to 8 sets of parameters for the pressure control loop. The sets can be switched during runtime and allow an easy and fast change to the optimal setting of the servo pump.

In addition the library includes filter mechanisms to reduce oscillations of the machine and ensure a constant pressure control if needed.

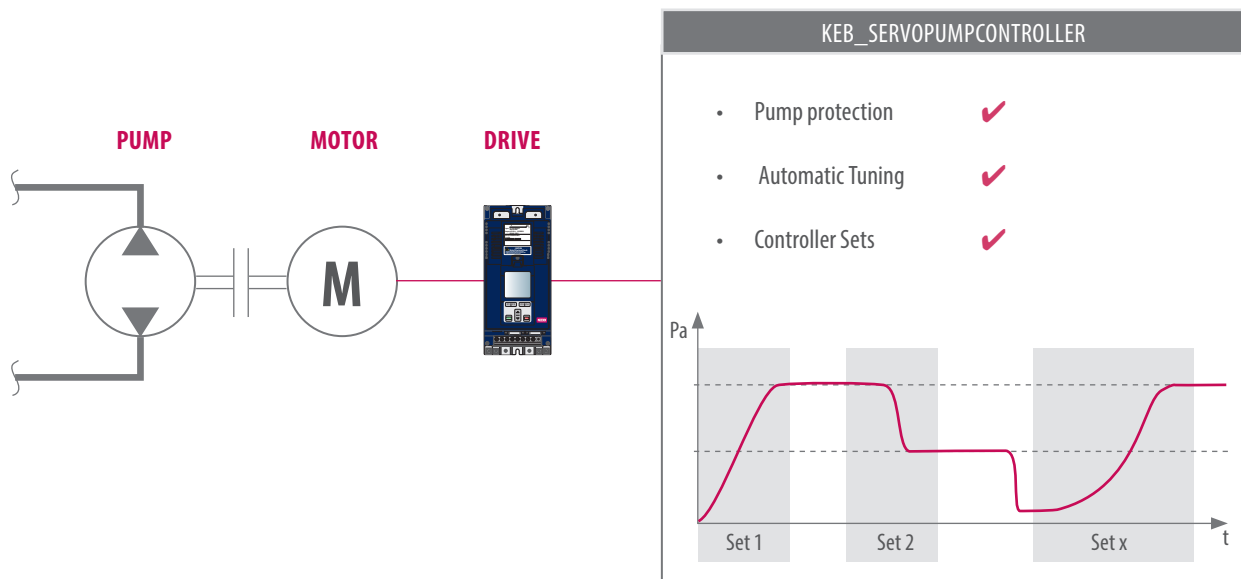

APPLICATION GROUP

- Plastic injection machinery
- Similar applications requiring highly dynamic servo pump control

REQUIREMENTS

- Control BASIC



HIGHLIGHTS

- Auto tuning for up to 8 Sets
- Several pump protection functions

KEB T6 APP UTILITY

APPLICATION:

The **KEB_T6_App_Utility** is the basis framework of each T6 inverter. The library start all basic functions of a T6 and offers an application slot for each DCU. The library already includes several apps for typical T6 applications. It also allows the user to create own apps for customer specific designs.

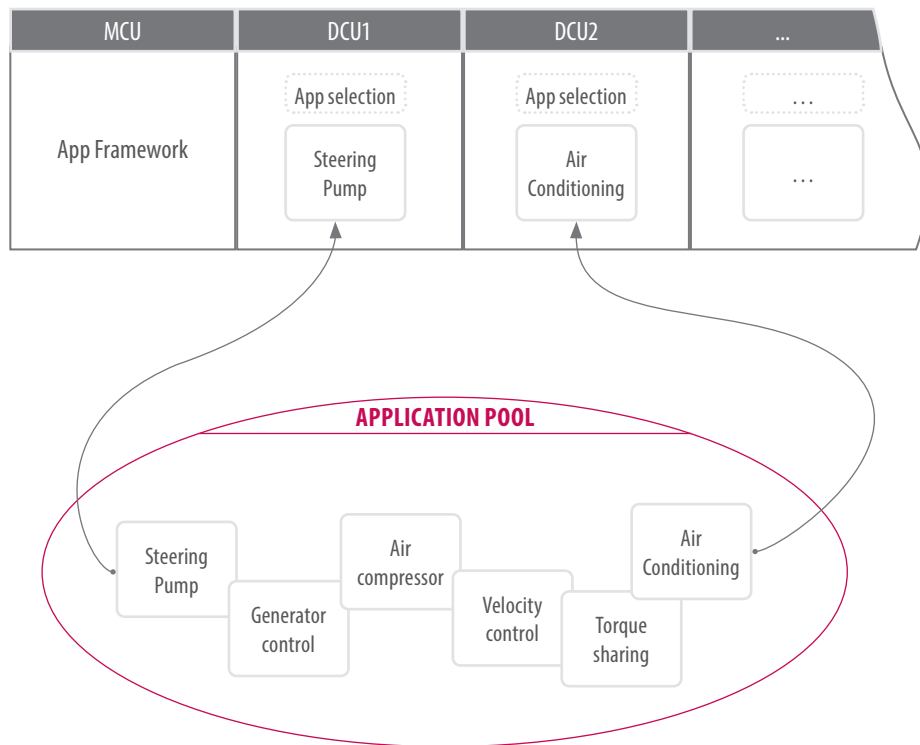

APPLICATION GROUP

- E-Mobility
- Application programming for commercial vehicles

REQUIREMENTS

- Included in COMBIVIS studio 6
-  Control BASIC



HIGHLIGHTS

- Modular extension of application
- Simple app programming due to preprogrammed basic functions
- Functionality extendable

APPLICATION:

The **KEB_File_Handling Library** allows an easy access to the file system of the IEC Runtime.

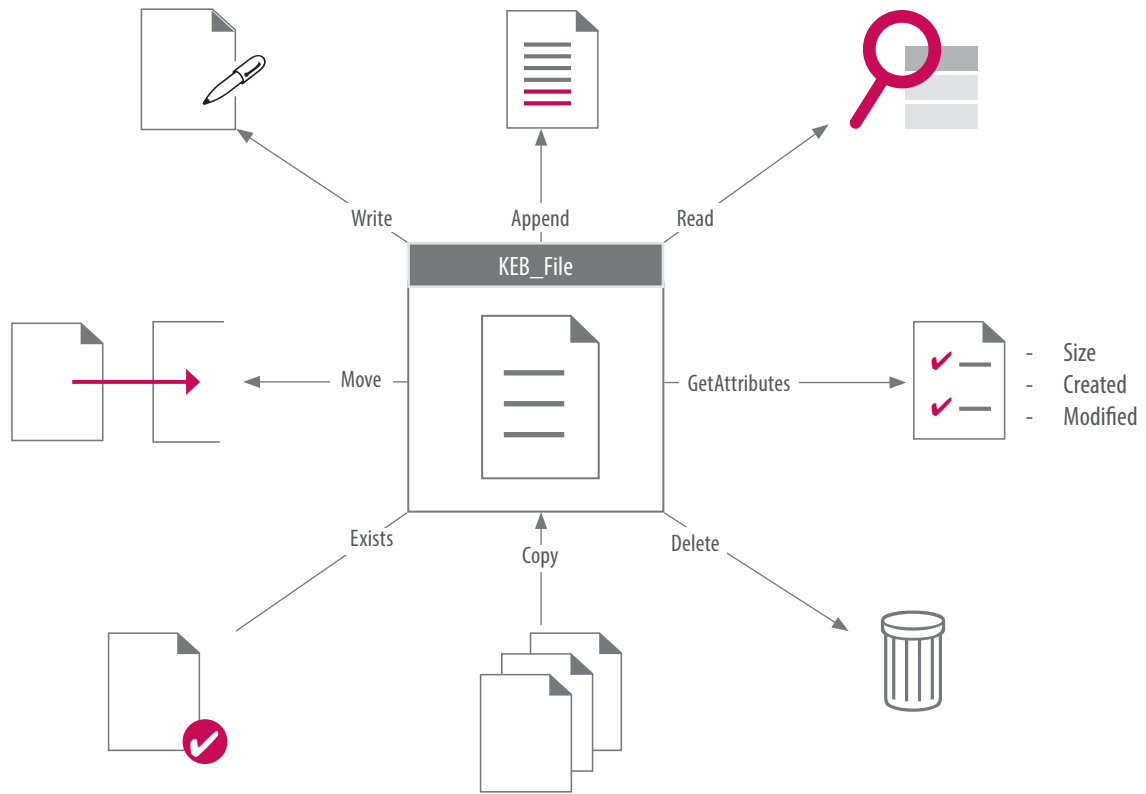

APPLICATION GROUP

- Library Development
- Application programming

REQUIREMENTS

- Included in COMBIVIS studio 6
- Control BASIC



HIGHLIGHTS

- Easy access to all file system functions
- All functions combined in one function module



Rezepte

Variablen:	Vorschau:	Aktueller Wert:
Word	2222	0000
DWord	22222	00000
Float		0,000
Bit		

KEB

- Menu
- Hauptseite
- Exit
- Video
- PDF
- Rezepte



COMBIVIS studio HMI

The design tool allows for the effective production of graphic user interfaces and status monitoring systems for industrial plants. A special feature is the universal nature and portability of produced projects, which thanks to the integrated driver database can be linked to all conventional control systems and scaled to any desired display size. The user benefits from extensive template libraries and a highly developed toolbox, and can include standard elements such as alarm handling, recipe management and database registration without programming knowledge.

VISUALIZE AND OPERATE



HMI Is the basis for visualization and operation tasks.
This symbol is placed by the available hardware.



BASIC function scope for KEB HMI.



PRO Professional function scope for KEB HMI (extended real-time database, data logger).



Advanced Advanced function scope for KEB HMI (webserver, multidrivers, SMS, email).

COMBIVIS studio HMI

PROJECT NAVIGATOR

for easy access to project resources.

CONTROL PANEL

contextual to the resource selected

REFACTORING EXPLORER

tool for automatic error correction

SCRIPT EDITOR

for compiling VBA, VB.NET and IL scripts and fault searching

OUTPUT WINDOW

for tracing all actions performed during development and run time

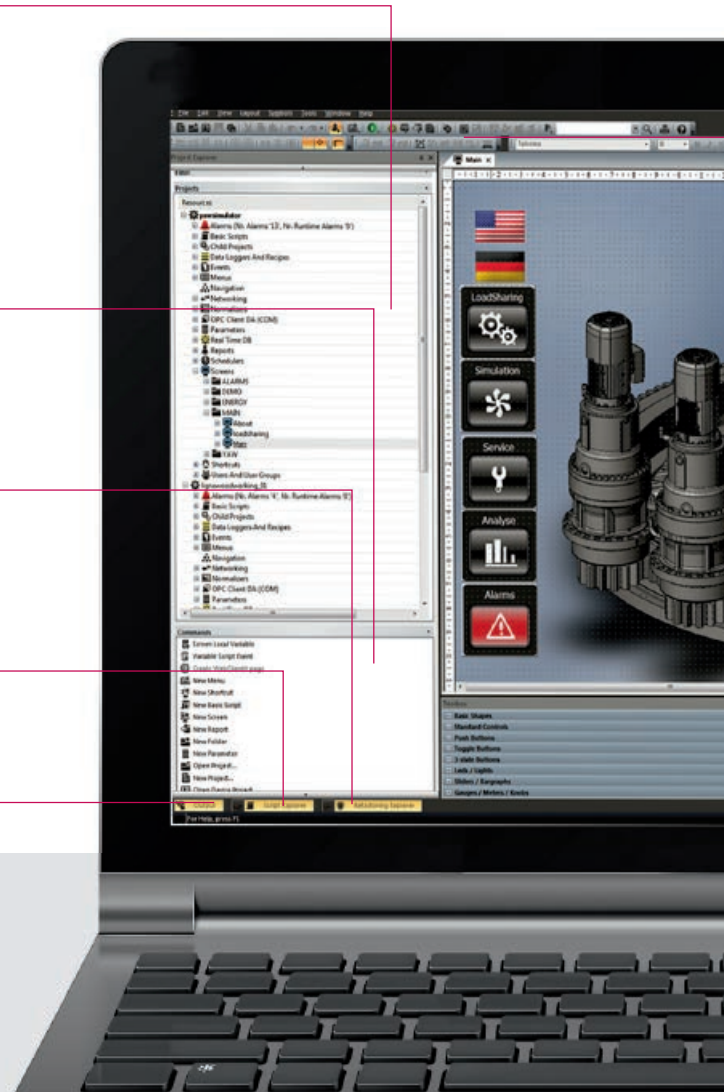

Created for development of user interfaces, applications for monitoring and data acquisition. With the Windows-based visualization tool COMBIVIS studio HMI, complete machines can be visualized within the KEB COMBIVIS studio 6 programming environment. The software can also be used as an independent tool for programming human machine interfaces.

The basic technology of XML ensures performance and flexibility on an open platform. The human machine interface can therefore be managed easily with production data and statistical analysis by means of XML. Scalability and flexibility come standard with COMBIVIS studio HMI. HMI solutions, once produced, can therefore be used on various KEB hardware devices - irrespective of whether they are based on Win CE or Win 32/64 operating systems.

There is no need for the complex reprogramming of screen masks when the hardware is updated in the background.

KEB has designed COMBIVIS studio HMI as an interpreting system. Since there is no compiling, once project objects have been produced they can be reused by simple cut and paste. Because of the KEB philosophy of using open standards, COMBIVIS studio HMI is also ideal for integration and data exchange with PPL and ERP systems, both locally and in remote operation.

The technologies supported by COMBIVIS studio HMI include: Web services, SVG Graphics, OPC, SQL, ODBC, .Net and Java-Machine for Web-Client solutions.



TOOLBARS AND SYSTEM INFORMATION

freely configurable and adjustable.

PROPERTY

for simple and intuitive object configurations and explorer resources.

GRAPHICS EDITOR

and synoptic functions for production and visualization.

TOOLBOX

object library, graphic symbols and templates



HIGHLIGHTS

- Open communications driver database
- Automated variable exchange
- Parallel development of HMI and controller projects
- Extensive template library
- High-level archiving possibilities

VISUALIZATION CONCEPT

Within the KEB world of drive and automation, there are no borders between device technology and software. Consequently, solutions for visualization, movement control and also remote maintenance can be used platform-independently on all KEB devices which have Win CE or Win 32/64 operating systems. So the choice of hardware suitable for an application is merely a question of the assigned task. Users therefore have a free choice of the form of automation:

an integrative approach with just one device, remote panel solution or a decentralized arrangement of core components on different products. Finally, it is the required performance which determines the best path, and not the restrictions of individual products - which is why at KEB, all devices available in the network can be linked together with just one connecting cable.



HIGHLIGHTS

- No borders between hardware and software
- Many drivers ensure communication at all levels
- Connectivity inside and outside the KEB automation world

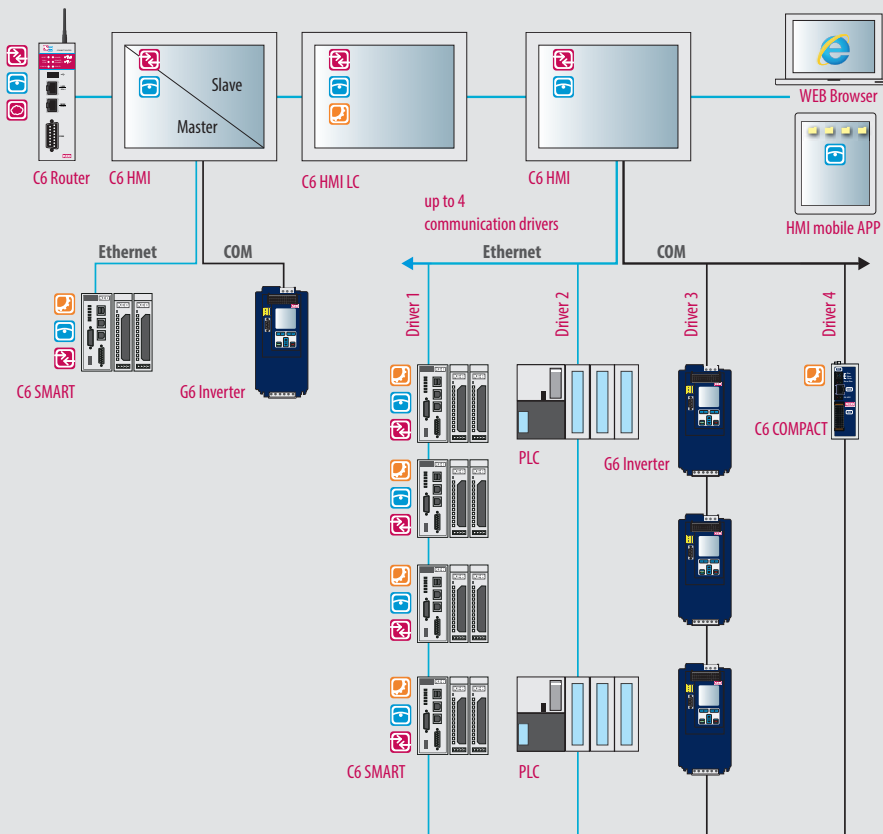

DRIVERS	HARDWARE INTERFACES			WIN CE	WIN 32/64
	Serial	Ethernet	ADD-ON		
COMBIVIS studio HMI Version 5.0. 1183.xx			ADD-ON	ARM	x86
KEB - PLC HANDLER (Elau, Parker...)		x		x ¹⁾	x
KEB - DIN66019II	x	x		x	x
B&R PVI with protocol INA 2000 ²⁾	x	x		x	x
B&R TCP ³⁾		x		x	x
BACNET IP ⁴⁾		x			x
BeckhoffTwincat (ADS protocol) ⁵⁾		x		x	x
KNX (EIBUS Konnex)	x	x			x
ELAP	x			x	x
FATEK		x		x	x
GE FANUC SNP-X	x				x
GE FANUC SRTP2		x		x	x
Hilscher NETLINK		x			x
Hilscher NETX MPI	x		NETCoreX MPI		x
Hilscher NETX PROFIBUS Slave	x		NETCoreX PROFIBUS SLAVE		x
Hitachi PLC serie H	x				x
LENZE LECOM AB	x			x	x
LonWorks	x	x			x
Mitsubishi MELSEC A		x			x
Mitsubishi MELSEC FX	x			x	x
Mitsubishi MELSEC Q	x	x		x	x
Mitsubishi FX3U TCP		x			x
Modbus RTU Master / Slave	x			x	x
Modbus TCP IP, Modbus TCP Server		x		x	x
Moeller SUCOM	x			x	x
OMRON ETHERNET IP		x		x	x
OMRON FINS	x	x		x	x
OMRON Host Link	x			x	x
PANASONIC FP MEWTOCOL	x	x		x	x
ROBOX		x		x	x
Rockwell DF1 and Data Highway	x			x	x
Rockwell Ethernet IP, Rockwell Ethernet IP 1800		x		x	x
SAIA via SCOMM DLL	x	x			x
SAIA S-BUS	x	x		x	x
SCHNEIDER UNITELWAY SLAVE	x			x	x
Shared Memory		x		x	x
SIEMENS MPI PC ADAPTER	x			x	x
SIEMENS S5 CPU, SIEMENS S5 DK3864R	x		RS232 to current loop convert	x	x
SIEMENS S7 200 PPI	x			x	x
SIEMENS S7 300/400 MPI	x			x	
SIEMENS S7 CP 300/400/1200 ⁶⁾		x		x	x
SIEMENS SAPI S7	x		SIEMENS CP5611, 5613, 5614, 5412, SIMATIC NET		x
SIEMENS TIA		x		x	x
SIEMENS SIMOTION		x		x	x

1) requires CoDeSys Gateway running on controller side, 2) requires an additional PLC communication library (license), 3) requires a FB into the B&R PLC without Libraries, 4) driver for building automation, 5) requires Beckhoff library (free of charge), 6) communication with S7-1200 controllers is supported only with absolute addressing (no symbolic addressing), 7) supports the variable import from TIA portal and the communication to S7-1200/1500 with absolute and symbolic addressing

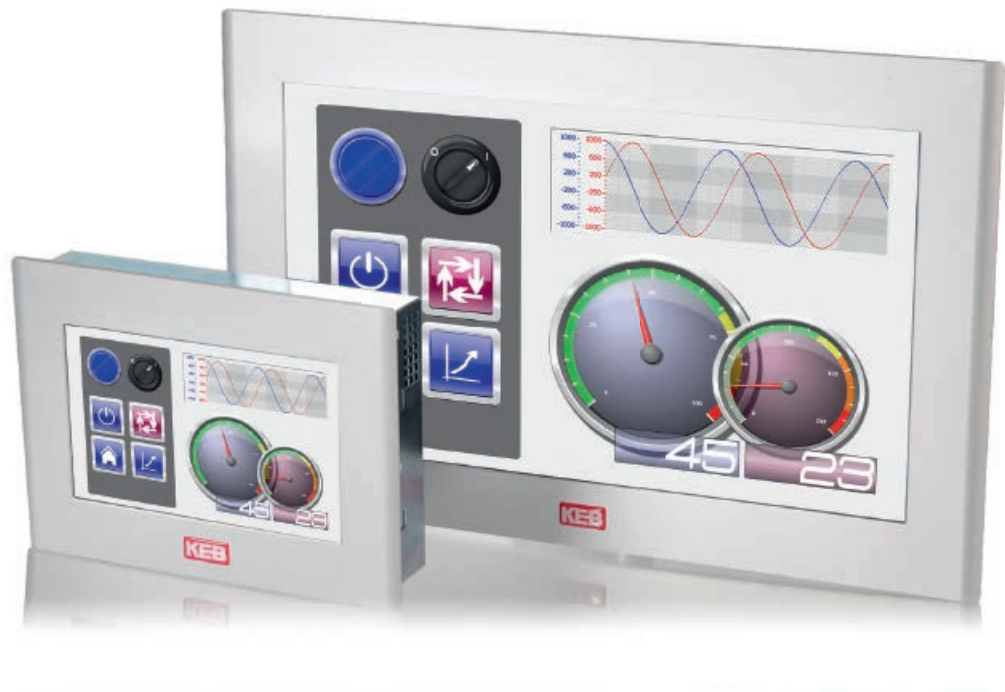

HIGHLIGHTS

- Project scalability independent of screen size
- Multitouch and gesture control
- Support for vector graphics and media functions such as videos, Office files, PDF
- Large library with elements, graphics and functional template

GRAPHIC FUNCTIONS

The products and tools for KEB visualization solutions are designed to meet even sophisticated demands in terms of speed and quality of graphics. Because project scalability is an absolute must in modern programming of visualization solutions, graphic projects which are produced in COMBIVIS studio HMI can later be displayed on different size HMIs. The projects produced with COMBIVIS studio HMI are platform-independent because they use an “interpreted language” which avoids special hardware compiling.

COMBIVIS studio HMI supports high-quality graphics in a simple way and automatically scales the objects to the size of the display. The use of vector graphics facilitates work with files of type bmp, gif, wmf and emf.

To ensure less distance between the Office world and industrial automation, all KEB products support the Media function. Files with extensions .doc, .xls, .ppt and .pdf can be opened directly from the visualization pages without needing to shut down the program.

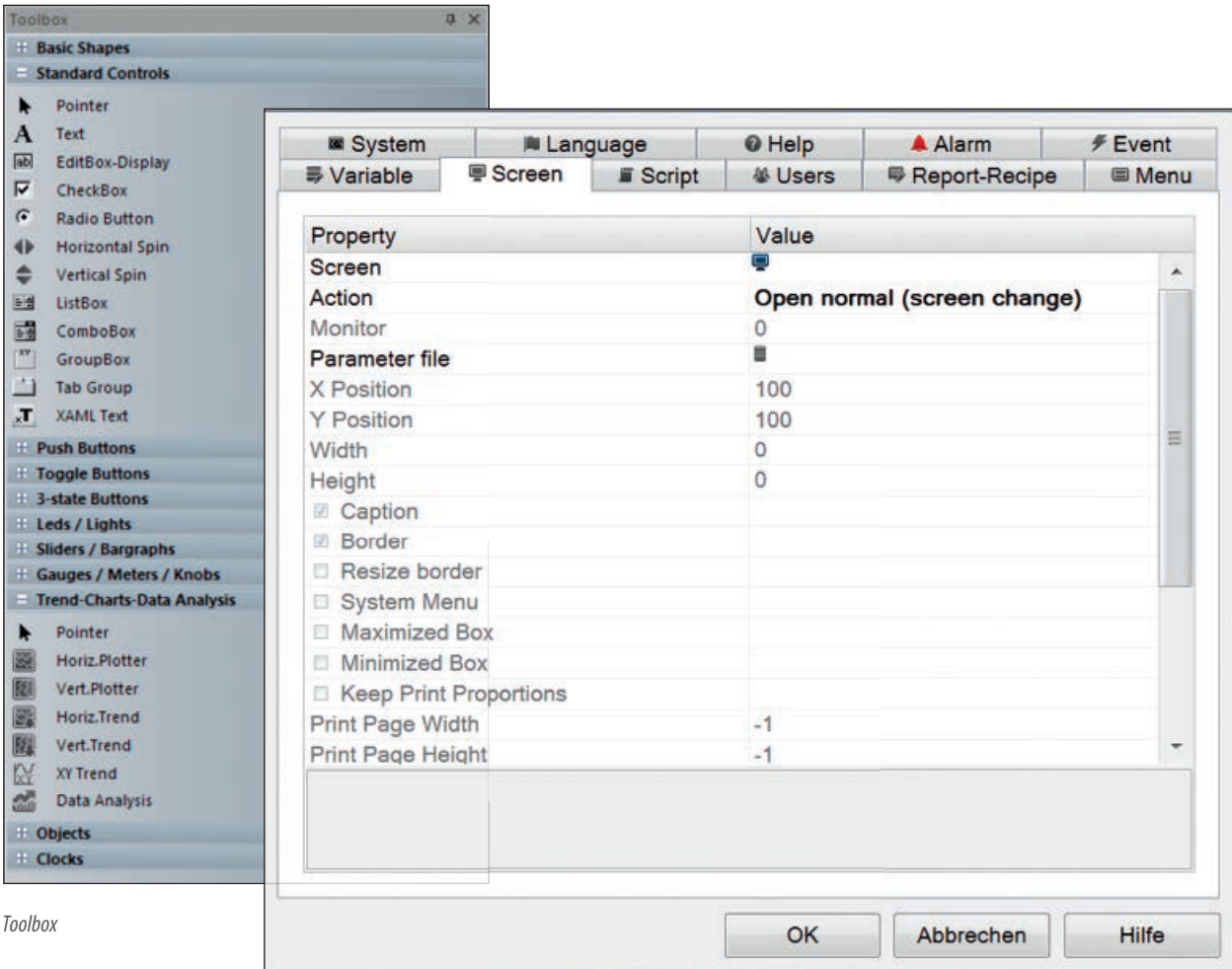

Toolbox

Properties

COMBIVIS studio HMI offers a wide range of graphic objects such as buttons, switches, meters or similar visualization elements. Each object has a large number of predefined properties and actions which can easily be adapted.

Power Templates are used to configure projects automatically. Here the user simply inserts symbols and screen masks. This can be done after producing predefined templates with special dynamic animations and VBA scripting functions. The export function means that these objects can be used with conventional Windows tools. Multi-monitor functions also create the basis of assigning a specific screen mask to monitors and creating a link for which page should be displayed on which monitor.

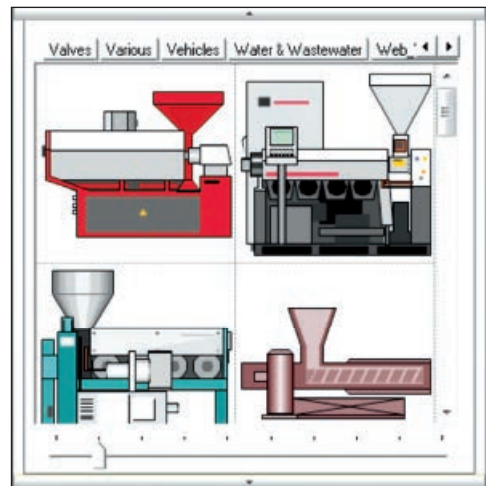

Object templates





COMBIVIS studio HMI

MULTITOUCH AND GESTURECONTROL

The Multi-touch feature is supported by COMBIVIS studio HMI starting from the COMBIVIS studio HMI 5 version.

The multi-touch is formatted in two parts, the hardware (a touch screen which recognizes multitouching simultaneously) and the operating system which recognizes points being touched and interprets them. When the software senses more than one touch gesture at the same time on the screen, it provides user interaction with project functions with intuitive gestures based on those frequently used in modern mobile devices such as table and smartphone to improve HMI systems use experience. In addition, COMBIVIS studio HMI supports the Multi-touch feature for multipoint tapping whereby two command objects can be tapped contemporarily which is handy for systems that need to ensure safety where both the user's hands must be present on the screen at startup or when activating particular commands.

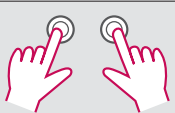

Pinch open	Zoom-Out the screen (Pinch&Zoom)	
Pinch Close	Zoom-In the screen (Pinch&Zoom)	
Pan	Move a previously zoomed area	
Scroll	Vertical scroll for lists and tables	
Flick	Scrolling the displayed area horizontally to view those parts that cannot be seen within the window or switching of the active Screen	
Touching two different command Objects at the same time.	The system allows individual commands of the two objects to be executed at the same time upon being pressed	

VARIABLES IMPORT

The KEB solution for visualization and control was developed with an eye to flexibility. The COMBIVIS studio platform for automation and human machine interfaces offers the user the opportunity of importing the entire database of control variables. This reduces development time since all the user need do is combine the controller with the HMI. Independent variable databases can be produced in the HMI project.

The variable database is a direct part of the visualization product, so an assistant is available which guides the user through the database import/export and handling. Everything necessary for the project is contained in the system. A wide range of system variables can be used in conjunction with the database for the PLC variables to make the customer’s work highly efficient, safe and stable.

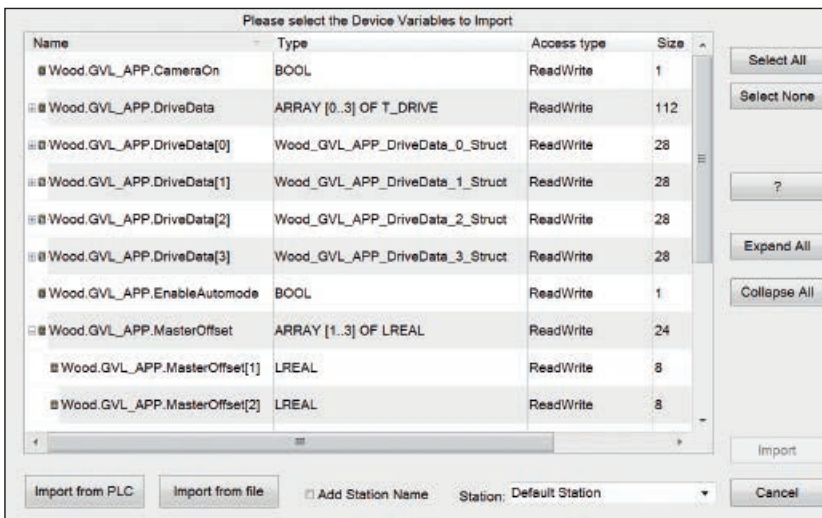

Variable database

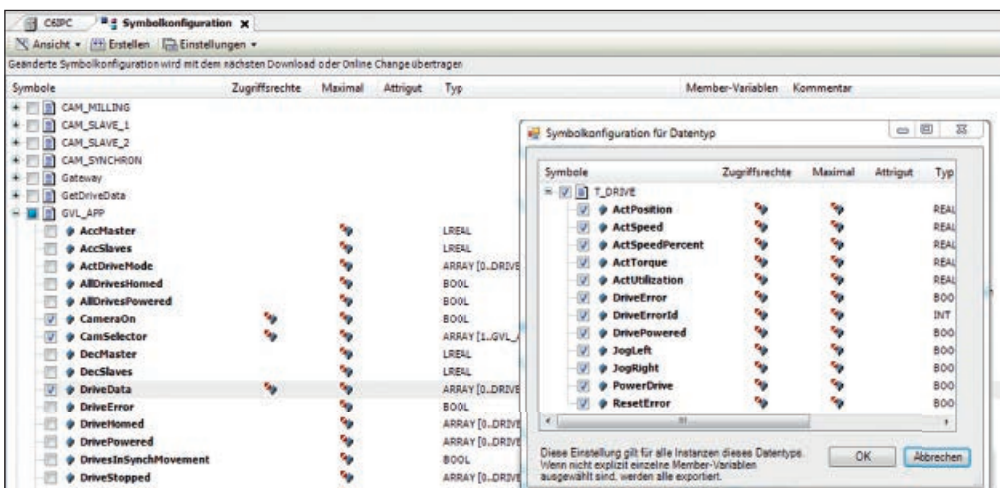

Symbol configuration

Depending on the number of variables required, the user can simply select the best HMI product. In KEB products, there are no restrictions for imported variables, just for the number of bytes in use (memory limit). Using the project navigator, the user can see the number of variables currently used and the peak usage value during project operation.

All variables displayed on the screen, and variables of data acquired and alarms monitored, are listed under “in use”. The programming environment automatically reports where the variables are used and, after double-clicking, jumps direct to the variable concerned.

DEBUGGEN AND LANGUAGES

In debug mode, a wide range of tools is available such as checking variable status, statistics and script checking. The statistics tool helps the user check the number of variables used in the project and find the correct hardware to support the variables range and the desired performance.

The user may exceed these limits for two hours for fault search and test purposes, but shut down and restart are required.

Item	Value	Quality	TimeStamp	In Use	Last Time Used
+ Mode	false	Good	24.04.2013 09:50:52.360	15	24.04.2013 10:56:17
- Automatic_cycle	0	Good	24.04.2013 09:50:52.360	6	24.04.2013 10:56:17
- Is used by...					
Watch Item					
Lathe_Reset_Automatic_cycle					
Lathe_Reset_Automatic_cycle					
Lathe_Inc_Automatic_cycle					
Lathe_auto_change_mode_0					
Lathe_auto_change_mode_1					
+ Automatic	false	Good	24.04.2013 09:50:52.346	8	24.04.2013 10:56:17
+ Blink	false	Good	24.04.2013 10:56:17.964	9	24.04.2013 10:56:17
+ Temp01	0	Good	24.04.2013 09:50:52.362	1	24.04.2013 10:56:17
+ CK01	1	Good	24.04.2013 10:57:24.529	2	24.04.2013 10:56:17

Watch window



HIGHLIGHTS

- Flexible import / export of variables between controller and visualization
- Convenient debug possibilities in simulation and on the actual device
- Shared memory
- Unrestricted multilanguage projects with support for special characters

Shared Memory: COMBIVIS studio HMI can export the variable database when using software from a third party supplier, which greatly simplifies the integration between existing hardware and software.

COMBIVIS studio HMI easily handles multilanguage projects using string tables. The tables can be exported into CSV format, sent for external translation and then reimported into the project. HMI multi-language supports all ASCII or Unicode UTF-16 standards.

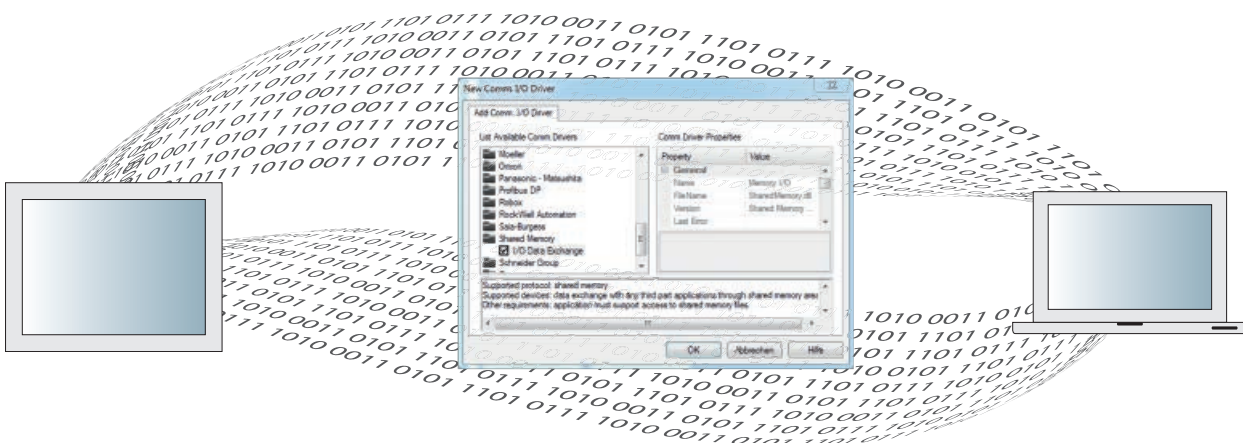

COMBIVIS studio HMI easily handles multilanguage projects using string tables. The tables can be exported into CSV format, sent for external translation and then reimported into the project. HMI multi-language supports all ASCII or Unicode UTF-16 standards.

Zeichenfolge-ID	chinese	english	french	german	ruussian
_HIGH_PADTEXT_	高限:	High Limit:	Limite Supérieure:	Obere Grenze:	Максимум:
_SEVERITY_DBFILTER_	重要级别:	Severity:	Sévérité:	Schweregrad:	Приоритет:
_SEVCOND_DBFILTER_	重要判断:	Severity Condition:	Condition de sévérité:	Schweregrad der Bedingung:	Условие Приоритета:
_TITLE_DBFILTER_	过滤:	Filter:	Filter:	Filter:	Фильтровать:
_TITLE_TRACECOMMENT_	跟踪说明 (审计跟踪记录):	Trace Comment (Audit Trail):	Commentaire Trace (Audit trail):	Trace-Kommentar (Audit Trail):	Комментарий Трейсера (Audit ...
_COMMENT_TRACECOMMENT_	说明:	Comment (Audit):	Commentaire (Audit):	Kommentar (Audit):	Комментарий (Проверка):
_TLEGEND_DESC_	说明:	Description:	Description:	Beschreibung:	Описание:
_NOTNUMERIC_PADTEXT_	请输入数字:	Please enter a number.	S'il vous plaît, entrez un numéro.	Bitte geben Sie eine Zahl ein.	Пожалуйста, введите номер:
_TODATE_DBFILTER_	结束时间:	To Date:	à la Date:	Bis Datum:	Финальные данные:
_OK_TRACECOMMENT_	确认:	OK:	OK:	OK:	OK:
_OK_DBFILTER_	确认:	OK:	OK:	OK:	OK:
_OK_GETPTEXT_	确认:	OK:	OK:	OK:	OK:
_OK_COMMENTACK_	确认:	OK:	OK:	OK:	OK:
_RESET_GETPTEXT_	登录后改变口令:	Change Password after Login:	Modifier mot de passe après L...:	Passwort nach Anmeldung än...:	Изменить Пароль после Входа:
_USER_GETPTEXT_	用户名(&U):	User Name:	Nom utilisateur:	Benutzername:	Имя Пользователя:
_USER_DBFILTER_	用户:	User:	Utilisateur:	Benutzer:	Пользователь:
_STATE_COMMENTACK_	状态:	State:	Etat:	Benutzer:	Статус:
_TIMEOFF_COMMENTACK_	消失时间:	Time Off:	Heure DIS:	Uhrzeit Aus:	Окончание:
_COMMENT_COMMENTACK_	注释(审核):	Comment (Audit):	Commentaire (Audit):	Kommentar (Audit):	Комментарий \n(Проверка):

Language table

RECIPES, DATALOGGER AND ALARM HANDLING

Recipe management is a standard in machine operation. The operator can select the recipe on the basis of the product requirements. If adaptations are required, the operator can save new settings under a new recipe. Each recipe contains a unique ID which prevents overwriting existing recipes. On the software side, there are no limits to the number of recipes; the memory on the motherboard is the only restricting factor.

Also with the KEB solution, recipes can be structured in a parent-child configuration so that general values can easily be passed on. Recipes can be saved manually or directly by extraction of historic data from a database. All this is achieved thanks to the commands and scripts of COMBIVIS studio HMI.

Screen masks for recipes can be produced manually or the integrated automatic assistant can be used. Each recipe contains a "Variable", a "Description", a "Value" and a "User unit", and can be encrypted for security.

The datalogger is an equally powerful tool and serves for recording and managing of data for the purpose of further database analysis, whether ODBC (Open Database Connectivity) or IMDB (In Memory DB) is used. The data may be stored as simple text, as XML files or in encrypted form.

For devices based on Windows CE, the use of IMDB avoids converting ODBC connections into ADOCE, and makes the installation of ADOCE and SQL Server CE components superfluous. The result is a lower system load from the Windows CE device and an improvement in performance.

Variable	Descri...	Value	Units	Min	Max
Wood_GVL_APP_MasterOffset_1		5		0	100
Wood_GVL_APP_MasterOffset_2		100		0	100
Wood_GVL_APP_PhaseShift_1		0		0	100
Wood_GVL_APP_PhaseShift_2		0		0	100
Wood_GVL_APP_VelMaster		25		0	120

Buttons: Activate, Read, Refresh, Save, Delete, Copy, Paste, Import, Export

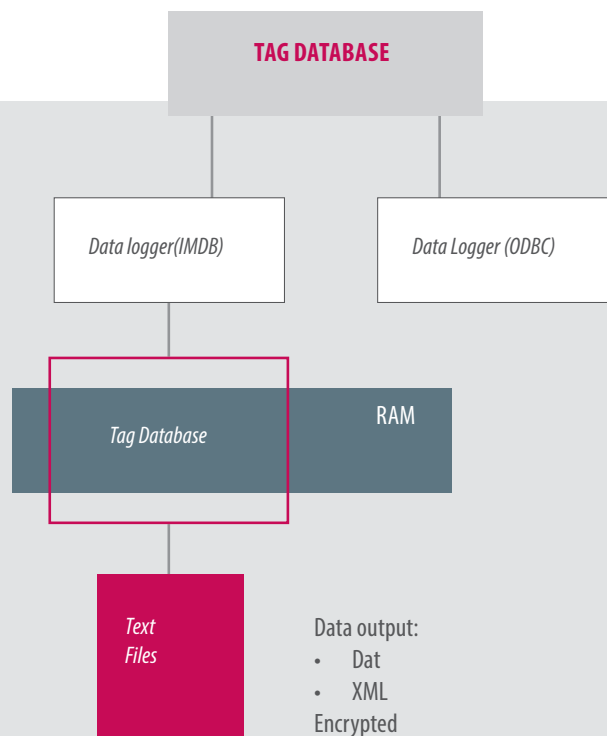
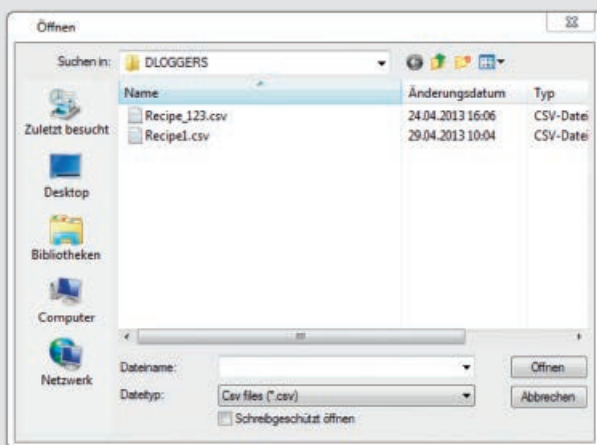

The data can be monitored using the raster object provided for this, which includes many functions such as an analysis filter. Variables can be sampled on a time basis, by command or by triggering. For WIN 32/64 operating systems, the standard ODBC interface to the Microsoft database can be set up locally or in remote mode.

For WIN CE, only local mode is supported. The list of ODBC types supported by KEB products includes the following: MS Access, MS SQL Server 2000, 2005, 2005 Express, 2008, 2008 Express, MySQL 5.1, and Oracle Express.

COMBIVIS studio HMI offers a power alarm management. The main task of the runtime is to generate an alarm in relation to a variable threshold value or a logic variable.

The COMBIVIS studio HMI alarm management is fully configurable and can meet the needs of every application. Project alarms are combined into groups which are in turn grouped into threshold values. The alarm activation can be triggered by a fixed or a variable threshold value. Acknowledgement and reset of each alarm are programmable.

Special priority levels can be assigned to each alarm so that the user can rapidly assess the situation. The alarms can also be grouped into areas for filtering the alarm displays.

Statistical calculations such as the frequency and duration of the alarms, and the reporting methods such as SMS, email, print spooling and scroll lock, are also integrated in COMBIVIS studio HMI.

Alarm Description	Time ON	Duration	Severity	Condition
Cauge 1 over 70	09.10.2015 13:21:17	0,00:00:01	1	OFF
Switch 1 push down	09.10.2015 13:21:...		1	ON
Swich 2 push down	19.11.2014 10:08:09	0,05:00:54	1	OFF

✓ ✓✓ ✗ ✗ 🔊 📄 🔍 📄✎

09.10.2015 13:21:17 Gauge 1 over 70	◀ ▶
-------------------------------------	-----



HIGHLIGHTS

- Existing recipe management with many possibilities for individualisation
- Datalogger and historic data are standard
- Wide support of different databases
- Continuous error management

TREND, TESTING & SAFETY

The Trend tool is a powerful observation tool for data recorded with the datalogger, and also a standard format CSV recorder. Thanks to the "Keep-in-Memory" function, recording is active even when the object is not displayed. The trend function was developed to offer maximum flexibility in the graphic display of recorded data.

The trend function of COMBIVIS studio HMI allows the user to view and monitor selected variables in a graphic format, and is the most effective way of saving, printing and analysing variables such as temperature, pressure, fill level, weighing cell and chemical measurement values.

The graphs can be displayed as follows: historically, in real-time, time-based or as X-Y diagrams.

When the trend function is started, the sampling and display settings selected for the user are loaded. The data buffer can be expanded up to 10,000 sampling values. When the trend function is stopped, the buffer contents are displayed. In the background however the trend function continues to sample and buffer values.

COMBIVIS studio HMI also has an audit trail tool for recording changes in specific variables together with the change cause in a database or text file. This provides a simple form of monitoring particular machine settings for changes over time, and the associated causes. This function is also used in connection with FDA standard 21 CFR Part 11.

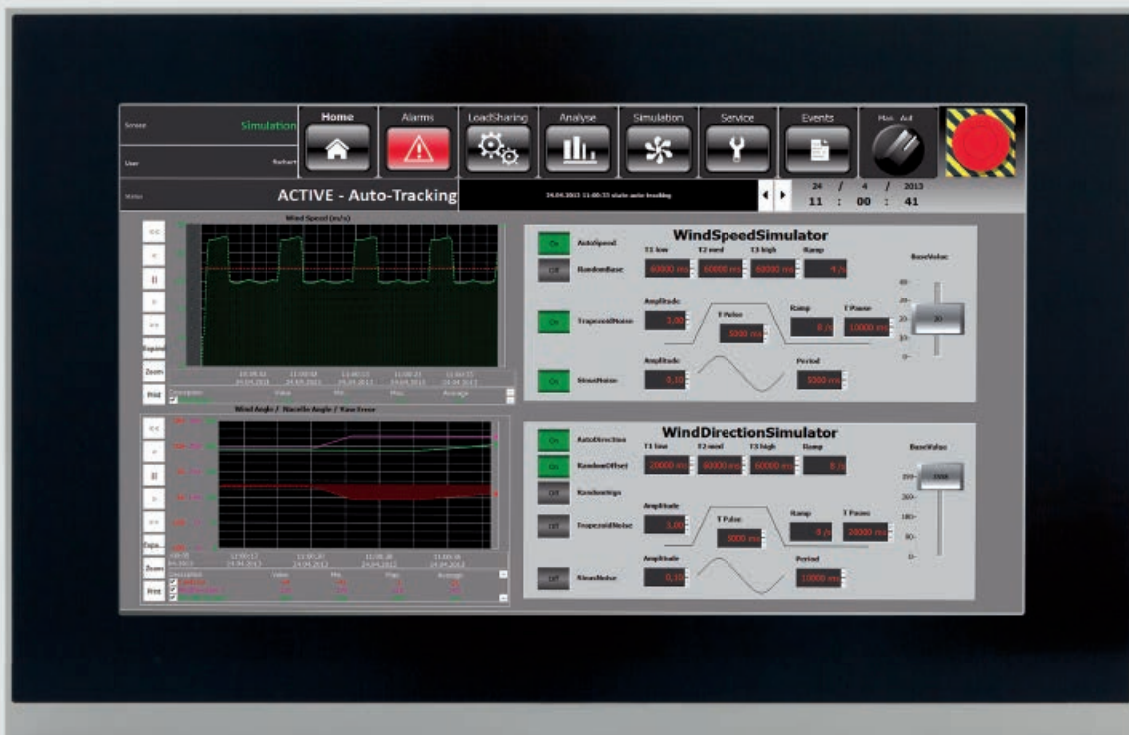

The KEB product range offers the user a high standard of safety. On the basis of the general properties of the user or user groups, it is possible to define how project safety should be managed. For example, password protection can be activated for editing/changing a project. Other passwords (user log on/log off) are possible in machine operation.

As soon as a user level is set to a particular value, only users of this or a higher level may make changes. All settings are stored in a file which can be saved in the runtime folder or externally after defining the network path for client-server projects.

The project can also be protected by a password which is required every time when programming or on start of runtime. Up to 1024 levels can be set. Activation of password management also requires password inputs for the runtime functions.

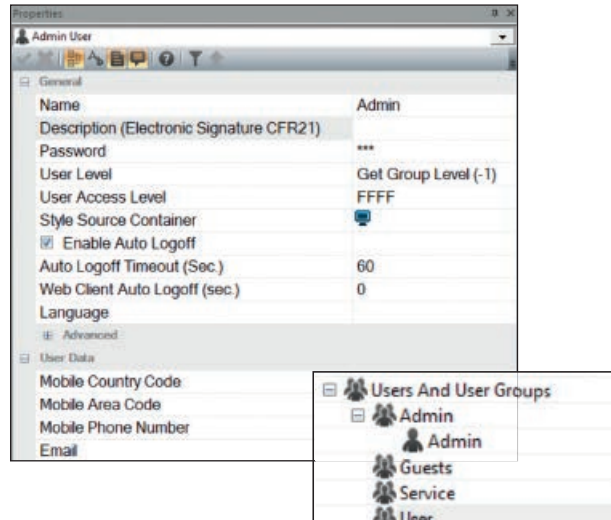

HIGHLIGHTS

- Flexible possibilities of trend depiction
- Integrated Audit Trail Tool (FDA Norm 21 CFR Part 11)
- Extensive user management (e.g. create new user in operation)

KEB products comply with FDA standard 21 CFR Part 11. According to the Food & Drug Administration (FDA), the purpose of the standard is to create a legal equivalence of electronic documents (electronic records and digital signatures) with traditional paper. This is necessary in view of the increased use of business automation devices and the extensive management of production processes which may be subject to checking and approval by the USA FDA.

To comply with standard 21 CFR Part 11, it is necessary to ensure that the operating personnel records are always reproducible (electronic signature). COMBIVIS studio HMI by KEB offers the opportunity of activating the necessary electronic signature easily as part of the user properties.

Many pharmaceutical companies are inclined to use the benefits resulting from the use of electronic records. The load from paper documentation which must be stored for many years is in itself a motivating factor.

In addition, the use of electronic records can substantially reduce the time for acquisition and checking of the necessary documents before medication is released to the market.

With the safety and access restrictions available, electronic records are protected from accidental loss, theft or falsification. This function is also used in connection with FDA standard 21 CFR Part 11.

PROJECT MANAGEMENT & CONNECTIVITY

COMBIVIS studio HMI offers a powerful and innovative function which allows you to meet new challenges in the development of monitoring systems.

Using the KEB tool, you can structure a project by the centralising resources to other projects ("children") with dynamic relationships, which creates the possibility of dividing the development tasks. A "child project" is a normal COMBIVIS studio HMI project which can work independently but is coupled to the "parent project" in a "parent- child" configuration. The parent project has all its own project resources plus the project resources of the child project.

To take this concept further, a parent project may contain several child projects, and a child project could itself contain one or more child projects and hence itself be a parent project. The overall result is a cascade project structure which is perfect for companies with divided software development and/or modular machine construction tasks.

OPC and OPC UA technology [OPC UA (Open Platform Communications Unified Architecture)] is a logical addition to COMBIVIS studio HMI's extensive communication driver database. In the application, a very flexible networking is possible, which can access both proven, proprietary services, as well as forward-looking standards.

The COMBIVIS studio HMI OPC UA integration sets new standards „ready-for-Industry 4.0“



Easy to use: Available servers are automatically detected or added easily via the network address. On the server the user can navigated directly to required variables and import them.

Easy Integration and Backward Compatibility: Existing projects can be augmented or renewed without touching the visual user front end. Communication drivers are easily exchanged or extended in the background.

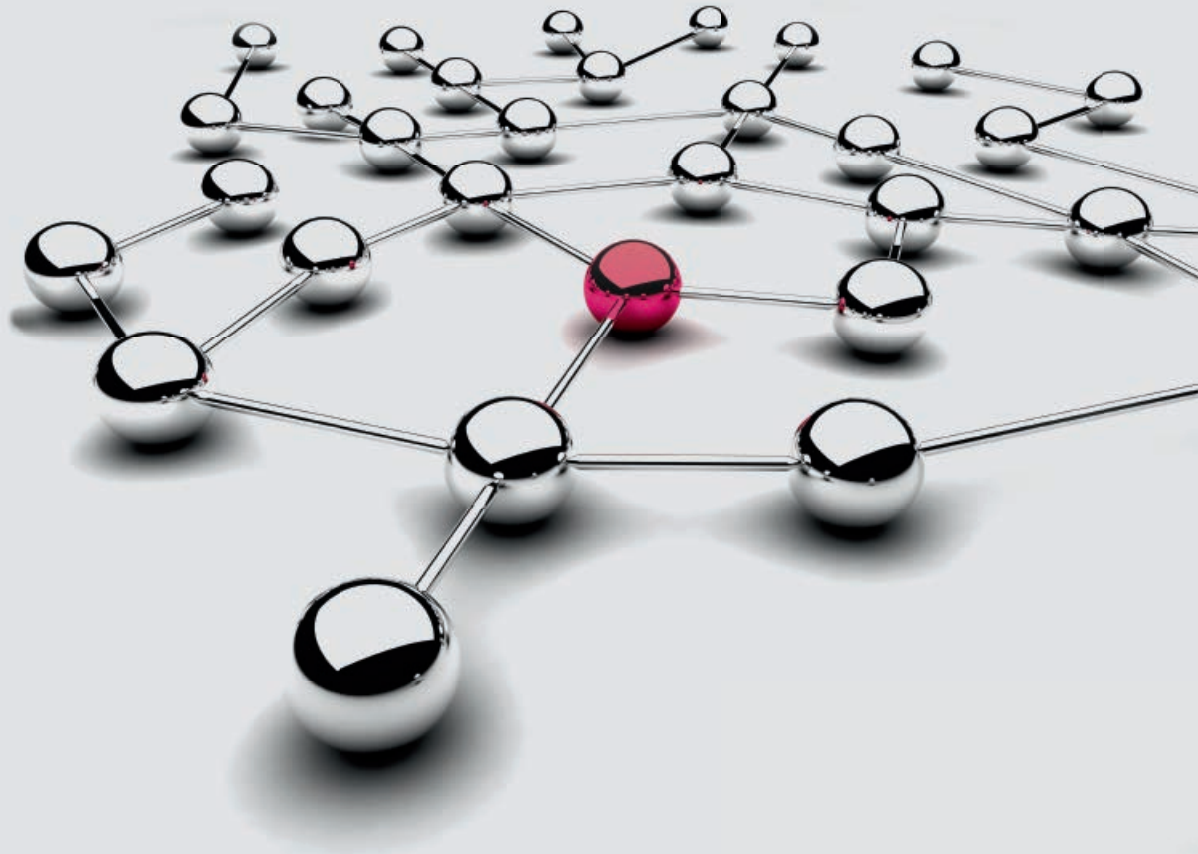

Redundancy and reliability: Simple configuration of backup servers and constant monitoring-of the communication via heartbeat mechanisms ensure reliability and high availability of important operating data.

The divided process control architecture increasingly calls for solutions for handling connected multiple cells and workstations, control-only or display-only stations, and multiple PCs.

The most logical solution is to interconnect these devices via an Ethernet connection. Since this offers high performance and low cost, the Ethernet connection is now by far the most common physical level. KEB's networking function uses the efficiency of the protocols which can run on Ethernet connections to connect COMBIVIS studio HMI stations together in client/server mode.

COMBIVIS studio HMI fulfills the requirements for connectivity and networking using the performance of TCP/IP, UDP and HTTP protocols which are already standard and used daily in Ethernet connections. These have

proven to be as popular as they are fast. With a few simple mouse clicks, two or more KEB stations can be connected together in a network. The variables in use are then exchanged between client and server.

KEB products were developed for good connectivity. In this connection, there is more than one possible way of reaching devices around the world. With KEB's HMI solutions, via a browser supporting Java Machine, a user can reach any device based on Windows CE or Windows 32/64 – with or without password protection.

Two users can be connected simultaneously. When accessing a browser on a device, a remote instance is formed which is different from the local display and thus allows the remote user free access to all screens without adversely affecting the screen of the local user.

For situations in which remote access to machines over the internet is not permitted, KEB offers the remote access tool COMBIVIS connect. COMBIVIS connect works independently of firewalls and creates an industrial VPN (virtual private network) for complete device access.



HIGHLIGHTS

- Project structure through parent-child projects
- Flexible OPC UA and OPC classic integration
- Connectivity within the automation system

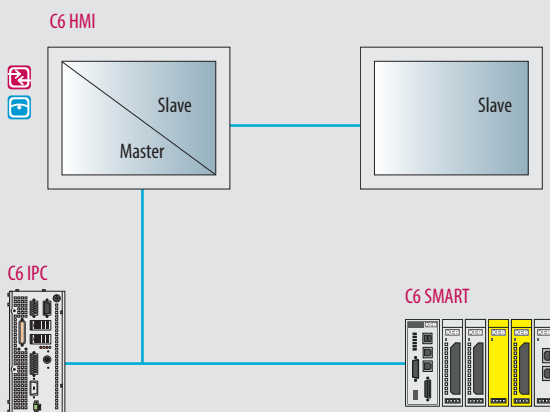

SCRIPT AND SCHEDULER

The performance of the KEB solution is also measured via its scripting functionality. For the most demanding customers looking for functions which are not available as standard in our development environment, the powerful VBA (Visual Basic Application) script language provides a custom solution. This function is available for both Windows CE and Windows 32/64 platforms. Win 32/64 platforms also support developments in VB.NET.

A scheduler tool is provided for products which call for commands to be executed at predefined times or at preset intervals. The scheduler is then responsible for executing a command or command list based on the system time of the PC. This function can drastically reduce machine development time and offers users advantages in performance. Thus for example, a machine can begin warming up before the workforce appears, or a machine can start a maintenance cycle every week.

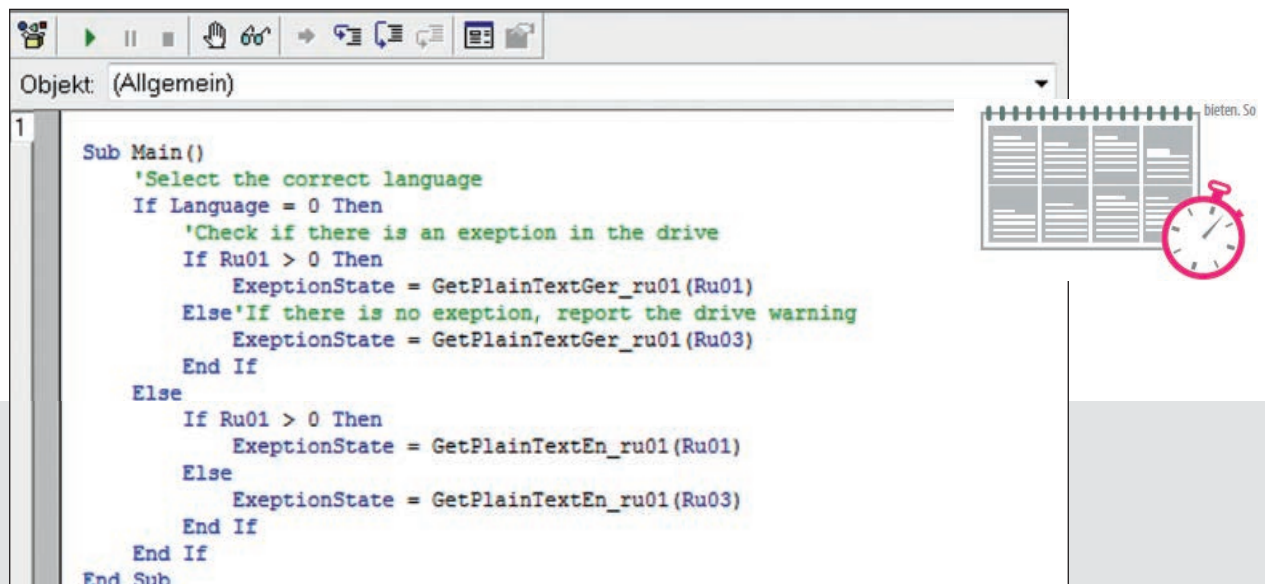

```
Objekt: (Allgemein)
1
Sub Main()
  'Select the correct language
  If Language = 0 Then
    'Check if there is an exception in the drive
    If Ru01 > 0 Then
      ExeptionState = GetPlainTextGer_ru01(Ru01)
    Else 'If there is no exeption, report the drive warning
      ExeptionState = GetPlainTextGer_ru01(Ru03)
    End If
  Else
    If Ru01 > 0 Then
      ExeptionState = GetPlainTextEn_ru01(Ru01)
    Else
      ExeptionState = GetPlainTextEn_ru01(Ru03)
    End If
  End If
End Sub
```



HIGHLIGHTS

- The open system means that all possible functions/expansions can be produced using Visual Basic Application
- Scheduler tool for time- or event-dependent tasks

FUNCTIONS	WINCE BASIC	WINCE ADVANCED	WIN32 BASIC	WIN32 PRO	WIN32 ADVANCED
REAL-TIME					
Real-time DB (max.)	1024 Byte	4096 Byte	2048 Byte	2048 Byte	4096 Byte
ODBC real-time	x	x	–	x	x
Trace DB	x	x	–	x	x
Object events	x	x	–	x	x
GRAPHIC INTERFACE					
Public symbols / Power Templates (VBA symbols)	x	x	–	x	x
Support of BMP, GIFF, JPG, WMF, EMF	x	x	x	x	x
Raster functionality	x	x	–	x	x
Dundas display instruments	–	–	x	x	x
Alias management in objects	x	x	–	x	x
Multi-Touch, gesture control	x	x	x	x	x
Objects via Drag and Drop	-	-	x	x	x
Window IP camera	x	x	x	x	x
ALARME AND ARCHIVE					
Historic management (CSV)	x	x	x	x	x
Historic management (ODBC)	x	x	–	x	x
Alarm transmission (SMS, email, voice)	–	x	–	–	x
SMS via SMPP protocol	–	x	–	–	x
Alarm management	x	x	x	x	x
DATA					
Recipe / Data Logger (XML)	x	x	x	x	x
Recipe / Data Logger (ODBC)	max. 2	x	–	x	x
TRENDS					
Real-time trend / historic trends (CSV file/Datalogger XML)	x	x	x	x	x
Historic trends database (ODBC)	x	x	–	x	x
Data analysis	x	x	–	x	x
USER					
User group management 1024 levels / run-time users	x	x	x	x	x
Dynamic multi language	x	x	x	x	x
CFR21	x	x	–	x	x
DRIVERS					
Max. number of drivers	max. 2	max. 4	max. 2	max. 2	max. 4
Event objects, time management	x	x	x	x	x
PLC Tag Importer	x	x	x	x	x
OPC Client XML DA	–	–	x	x	x
OPC Client UA, OPC Client DA	x	x	x	x	x
LOGIC					
IL Logic (Step5-Step7)	x	x	x	x	x
VBA Logic (WinWrap Basic)	x	x	max. 2 scripts	x	x
VBA interface communication drivers	x	x	–	x	x
VARIOUS					
Subprojects	x	x	–	x	x
Process image navigation	x	x	–	x	x
Web client	–	max. 4 clients	–	–	max. 2 clients
COMBIVIS HMI mobile	–	x	-	-	x





COMBIVIS HMI mobile

The COMBIVIS HMI mobile app allows the user to operate machine visualization via mobile devices such as tablets or smartphones connected via Wi-Fi. On start-up, fault search, setup or in normal operation, this functionality offers great added value for everyday work.

This tool offers new potential for plant management. COMBIVIS HMI mobile can be downloaded free via App Store or Google Play and requires "ADVANCED" functionality on the visualization devices.

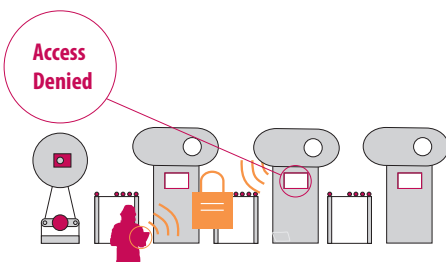
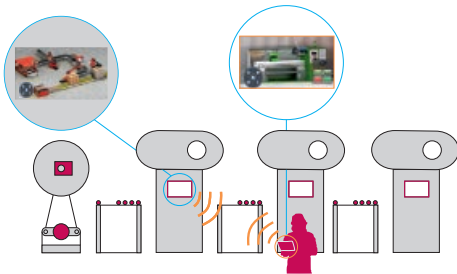
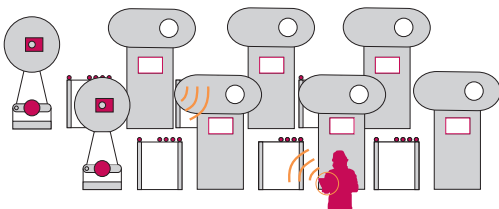

BETTER PRODUCTION MONITORING

COMBIVIS HMI Mobile allows continuous monitoring and more efficient and flexible control of machines. Direct diagnosis and operation of the plant are independent of the fixed installed position of the HMI.

INDEPENDENT INSTANCE

Thanks to the software setup of COMBIVIS HMI for connection of Web interfaces, project management on COMBIVIS HMI Mobile is independent of local users. Thus the HMI of the machine can be operated normally at the same time.

COMBIVIS HMI Mobile also allows selection of the display resolution of the iOS/Android devices independently of the resolution of the machine terminal, offering full comfort on mobile devices.

SAFETY AND USER MANAGEMENT

COMBIVIS HMI Mobile uses the user management and safety of the HMI project concerned, and controls log-on and access to pages and functions. When these safety functions are used, COMBIVIS HMI mobile can only access the machine with the help of the access data.



KEB



COMBIVIS CONNECT FUNCTIONALITY

The rapid and secure remote maintenance platform ensures optimum service conditions in a modern automation system. Via safe end-to-end connections, the centrally managed devices are quickly available without local presence - at any time and anywhere in the world. Furthermore, regular data recording ensures transparent depiction of machine data and allows the best possible analysis and continuous improvement process.

INNOVATIVE SOFTWARE FOR OPEN REMOTE MAINTENANCE TECHNOLOGY



CONNECT is the basis for professional remote maintenance.
This symbol is placed by the available hardware.

COMBIVIS CONNECT

REMOTE MAINTENANCE SOFTWARE WITH A FUTURE

COMBIVIS connect is the future-oriented remote maintenance solution from KEB for the Win32 and Win CE operating systems. It allows automation of machines and plant to be monitored and controlled remotely.



HIGHLIGHTS

- Remote management of KEB device series on which COMBIVIS connect is installed.
- Programming, fault search and update of projects working on remote devices in the same subnetwork
- Creates a VPN connection between an operator PC and the remote device by activation of the subnetwork access
- Activates safety processes with end-to-end sessions without intermediary
- Redundant and distributed server architecture guarantees reliability and transmission stability

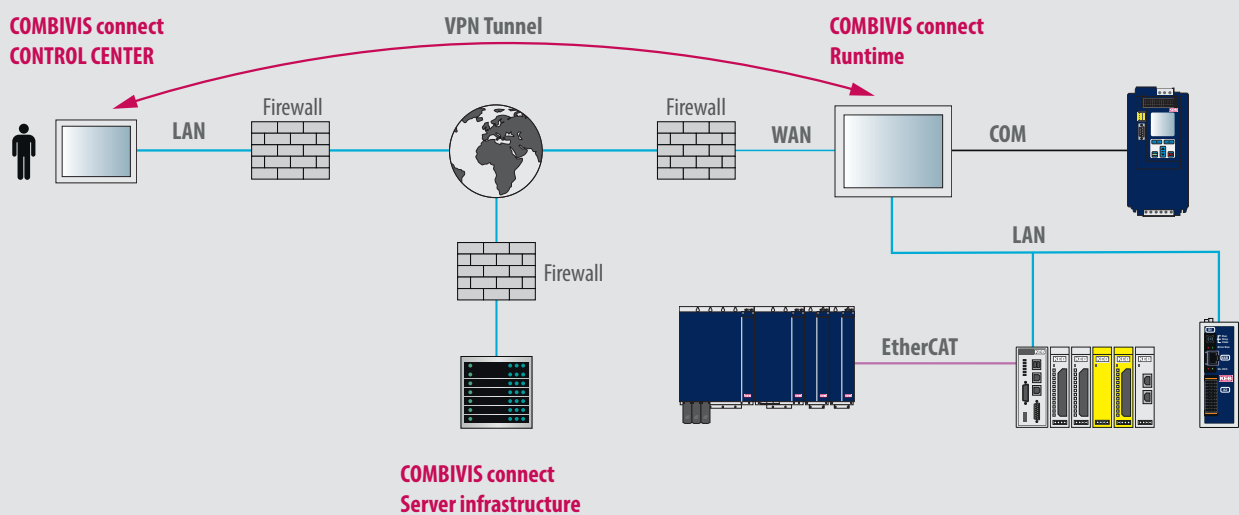

COMPONENT SPECIFICATION

COMBIVIS CONNECT CONTROL CENTER



This tool is designed to carry out remote maintenance as simply as possible without great expense, to access domains, manage users and their rights, and register devices. The COMBIVIS connect Control Center is simply installed on the corresponding PCs of the colleagues concerned.

COMBIVIS CONNECT RUNTIME

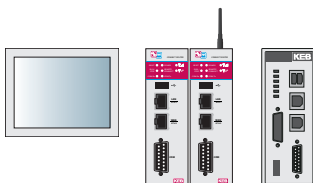

Runtime contains the installed and executing components on the remote C6 devices. This is what monitors and controls the automatic process and makes the end-to-end VPN connection possible.

COMBIVIS CONNECT SERVER INFRASTRUCTURE



Communication between the Control Center and Runtime is reliably created and managed by the redundant server infrastructure. The latest safety standards guarantee maximum data protection.

COMBIVIS CONNECT DOMAIN



COMBIVIS connect Domain virtually reproduces the customer account in order to be able to use all services and own infrastructures of the KEB remote maintenance solution.

COMBIVIS CONNECT

COMBIVIS CONNECT SERVER INFRASTRUCTURE

A redundantly structured, worldwide distributed server infrastructure guarantees access to remote devices at all times. The system is built so strongly that there are no limits in relation to number of users and devices for customers within their own domain.



CLOUD-BASED ACCESS

KEB stores COMBIVIS connect Domain in structured fashion in a cloud. This architecture at the same time ensures maximum data security and continuity of service. Colleagues can start the Control Center independently of their current location, and access remote machines. The cloud does not store any project data but with background execution programs deals rather with the registration and management of devices, users, user groups and authorisation profiles.

SAFELY PROTECTED VPN

COMBIVIS connect works at the level of the data link layer. This technology brings firm benefits in comparison with VPN-based network layers.

- Because after logging in, the Control Center PC becomes a true member of the remote host network, it is also assigned an IP address from the same physical IP address range.
- For remote operation, users can use broadcast-based protocols.
- Device access requires no additional gateway configuration.

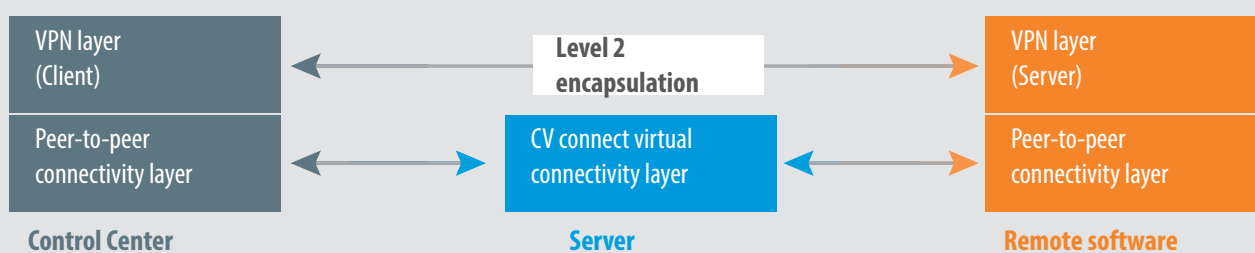

CERTIFIED SECURITY

With COMBIVIS connect, data protection and data security come first. To underline this, the COMBIVIS connect Access Servers, the C6 Routers, the Control Center, as well as all Runtimes as of version 8 have been certified according to the international standard IEC 62443- for Industrial Communication Networks and IT Security for Networks and Systems. This allows among other things the configuration of a secure password assignment.



COMPATIBILITY WITH EXISTING FIREWALLS

COMBIVIS connect Control Center and COMBIVIS connect Runtime connections are configured as outgoing connections which are acknowledged as secure and therefore acceptable according to firewall guidelines.

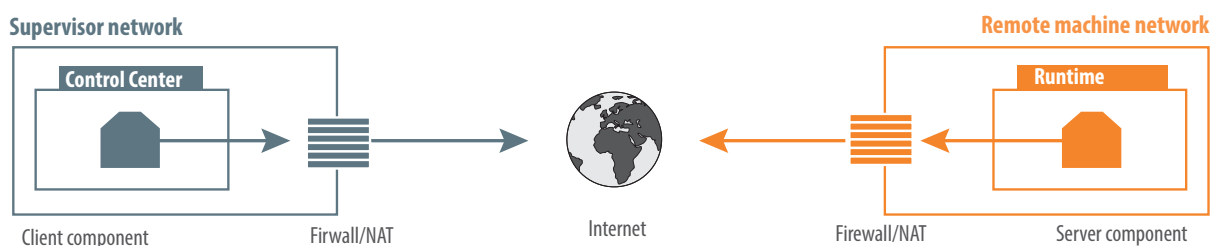

HIGHLIGHTS

- Network and firewall of the end user need not be configured
- COMBIVIS connect automatically uses released TCP and UDP protocols and can use HTTP, HTTPS or user-defined ports
- Compatibility with existing IT security guidelines is guaranteed

COMBIVIS CONNECT

INTEGRATED COMBIVIS CONNECT FIREWALL

The firewall integrated in COMBIVIS connect controls the communication packets which are sent by the VPN. It is possible to filter Ethernet data packets depending on communication protocols and destination addresses. The filter rules can be assigned to individual users or user groups, and the server infrastructure provides a library of ready-made guidelines. This leads to greater safety and bandwidth control, and increased flexibility in the field of access rights.

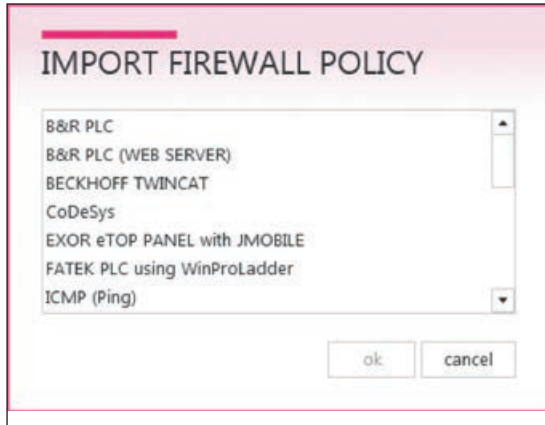

MULTICLIENT

COMBIVIS connect Runtime allows simultaneous access to a remote system with several connections.

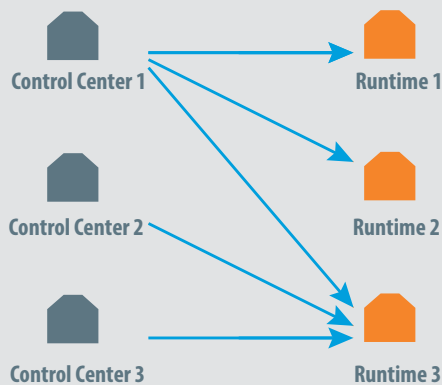

HIGHLIGHTS

- The Control Center can activate interactive sessions with different devices and just one VPN connection via a remote device.
- The overall advantage: because more users can work simultaneously on a remote maintenance project, productivity is increased.

ALWAYS UP TO DATE

The new update function makes it possible to easily update the runtime of the devices by remote maintenance. This saves a time-consuming and expensive service call. Existing device groups can benefit directly from updated security features.

The system administrator has full control over all software updates. Device, update type and time can be planned individually. Thus, already at work time relevant update can be pre-activated. The update itself can be scheduled for instance during a production break at the weekend.

Optionale grafik

The screenshot shows a web interface for managing devices. A table lists various devices with their client versions and update statuses. A 'SCHEDULE UPDATE' dialog box is open, allowing the user to select a version to update to (currently 'Official') and when to schedule the update (currently 'Now').

Name	Client Version	Update Status
AMTB_031_C6_SMART	10.1.051	Up-to-date
AMTB_MasterPLC	9.0.031	Available
HMI Verschleißprüfstand Nr. 4	8.0.013	Available
HMI Verschleißprüfstand Nr. 5	8.0.013	Available
INV037_C6 HMI LC 10_1z 172.17.129.136	9.0.031	Available
Prüfst Device access	4.0.010	Available
Prüfst Connect VPN	4.0.010	Available
Prüfst Update	4.0.010	Available
Prüfst	4.0.010	Available
Smart Locate in domain view	8.0.013	Available
Smart Locate in map view	8.0.013	Available

ACCESS ACTIVITY STATISTICS

COMBIVIS connect records and saves all remote access activities at the respective domain.

Network administrators have a full overview of who has worked for how long on a project. The resulting record of time spent can be used for example for later invoicing of an after-sales service.

The accurate combination of orders performed, specifying operator, remote PC and connection time, gives a transparent proof of activity for the end customer.

The screenshot shows a web interface for viewing access activity statistics. It includes filter options for user name, PC name, and date. A table displays the following data:

User Name	Remote PC	Connection time	Disconnection time	Span
meyer	B13_Router_Barntrup	21.10.2015 13:20:59	21.10.2015 14:06:17	0 h 45 m
meyer	B13_Router_Barntrup	21.10.2015 13:20:17	21.10.2015 13:20:37	0 h 00 m
loestd	B13_Router_Barntrup	21.10.2015 13:14:22	21.10.2015 13:15:05	0 h 00 m
meyer	B13_Router_Barntrup	21.10.2015 13:07:39	21.10.2015 13:20:13	0 h 12 m
meyer	B13_Router_Barntrup	21.10.2015 13:05:31	21.10.2015 13:07:39	0 h 02 m
meyer	B13_Router_Barntrup	21.10.2015 13:02:17	21.10.2015 13:05:30	0 h 03 m
meyer	B13_Router_Barntrup	21.10.2015 12:10:33	21.10.2015 13:01:44	0 h 51 m
schoenemannv	Prüfstand Nr. 5	21.10.2015 11:45:41	21.10.2015 12:06:57	0 h 21 m
schoenemannv	Prüfstand Nr. 5	21.10.2015 11:45:15	21.10.2015 11:45:41	0 h 00 m
schoenemannv	Prüfstand Nr. 5	21.10.2015 11:20:59	21.10.2015 11:30:32	0 h 09 m
schoenemannv	Prüfstand Nr. 5	21.10.2015 11:03:56	21.10.2015 11:19:23	0 h 15 m
schoenemannv	Prüfstand Nr. 5	21.10.2015 11:02:06	21.10.2015 11:03:02	0 h 00 m

MANAGEMENT OF ACCESS RIGHTS

With COMBIVIS connect, an unlimited number of users, user groups and devices can be defined each with different access rules. Authorisations can be configured flexibly from folder level to the individual device.

- Directory and user management by administrator
- Device installer for inclusion of new devices in the domain
- Network security for configuration of own firewall rules
- Remote access as a basis for remote sessions

The benefits:

- Users can produce and manage their own organisation structure
- Flexible and controlled possibility of reaching all customers world-wide
- Only authorised personnel have secure and structured access to remote devices

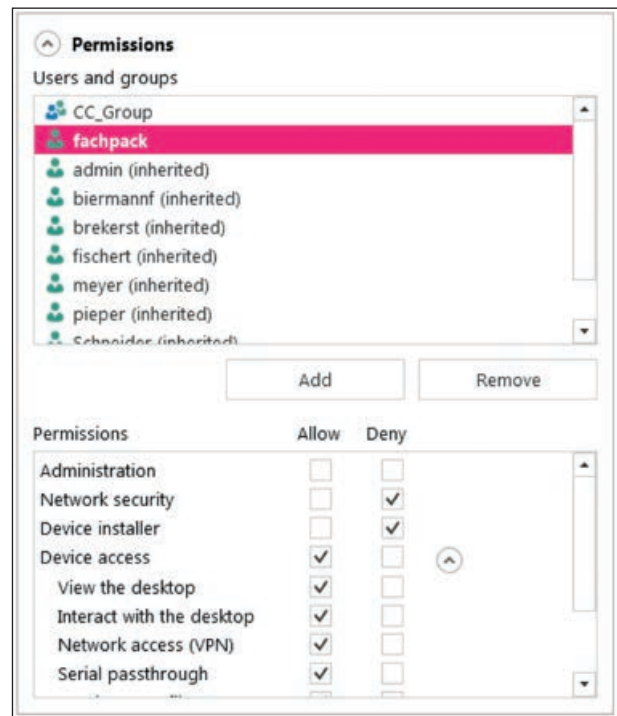

GEO LOCATION

All devices integrated in the domain are displayed in a geographical map. These devices are located via the public IP address. If multiple devices share the same public IP address, they are displayed together in a pushpin. A number in it indicates how many devices are located at this location.

If the positioning via the public IP is not precise enough, this function enables manual position entry via address or geographical coordinates. When using a SIM card, the location accuracy depends on the provider.

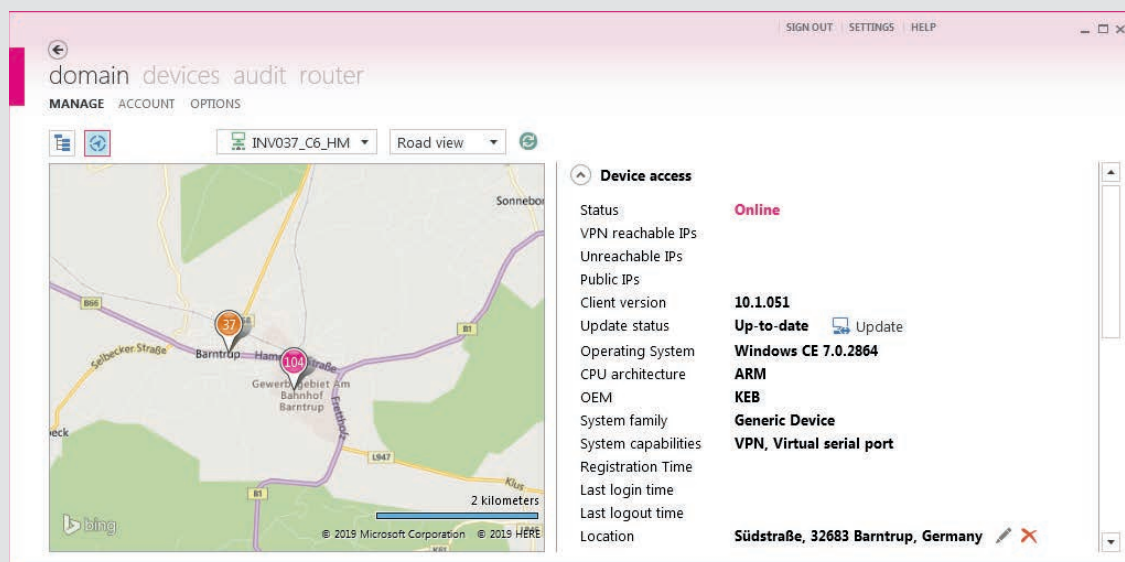

SECURE VPN CONNECTION

COMBIVIS connect automatically installs a VPN adapter on the Control Center PC. The virtual Ethernet adapter works as a VPN client and receives an IP address from the existing VPN network from the remote device (VPN server). There is a direct end-to-end connection between the communication partners.

- The connection is securely protected from external access and manipulations, to all IP-based devices in the VPN network.
- Quick search for KEB devices via COMBIVIS 6

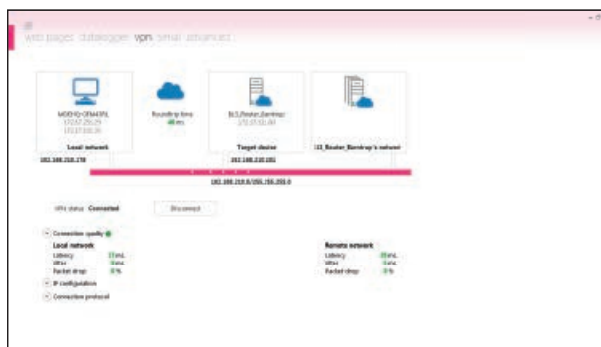

VIRTUAL SERIAL CONNECTION

COMBIVIS connect automatically installs a virtual serial adapter on the Control Center PC. The virtual serial port of the Control Center PC can be mapped to a physically present port of the remote device if COMBIVIS connect Runtime is installed. The serial connection mode provides the opportunity of serial communication via RS232, RS422, RS485 or MPI.

- Even remote serial devices can be monitored, diagnosed and adapted for new tasks.
- You can also search for individual KEB devices in a targeted fashion in COMBIVIS 6 in serial communication.

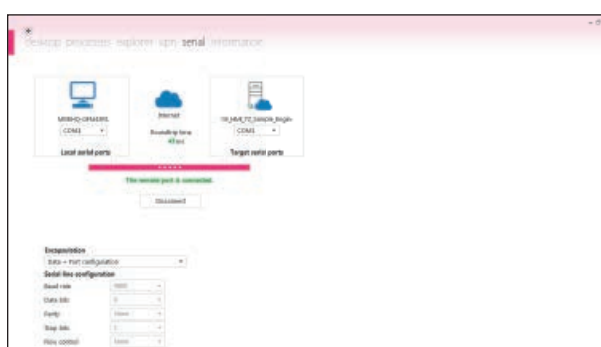

CHAT BETWEEN LOCAL AND REMOTE PC

To allow the exchange of important information quickly in a project, KEB has provided a chat function in the remote maintenance solution. This allows direct communication without separate telephone conferences, because the technician at the CONTROL Center is directly connected via the remote maintenance network to the remote engineer on site in on-line chat.

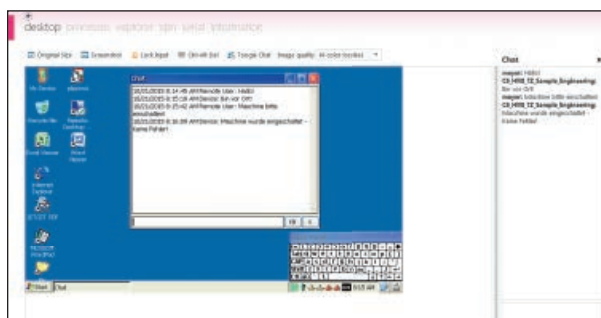

REMOTE DESKTOP FUNCTION

The Control Center software offers a remote function with which desktops of remote devices can be operated remotely, without additional services or support programs.

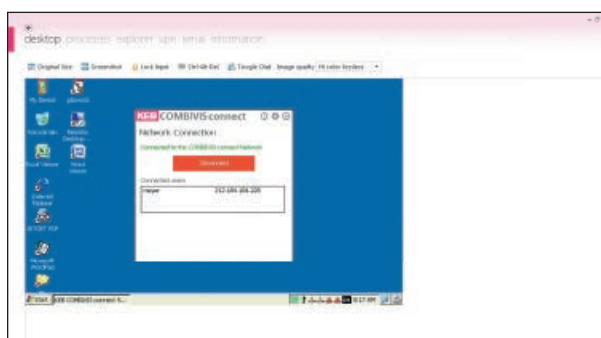

COMBIVIS CONNECT

DEVICE MANAGEMENT

C6 IPCs and C6 HMIs with COMBIVIS connect Runtime can be included in a domain using their ID and a password, and registered with their serial number. This excludes registration under further domains, which safely prevents access outside the domain. The unique access rules extend to device level.

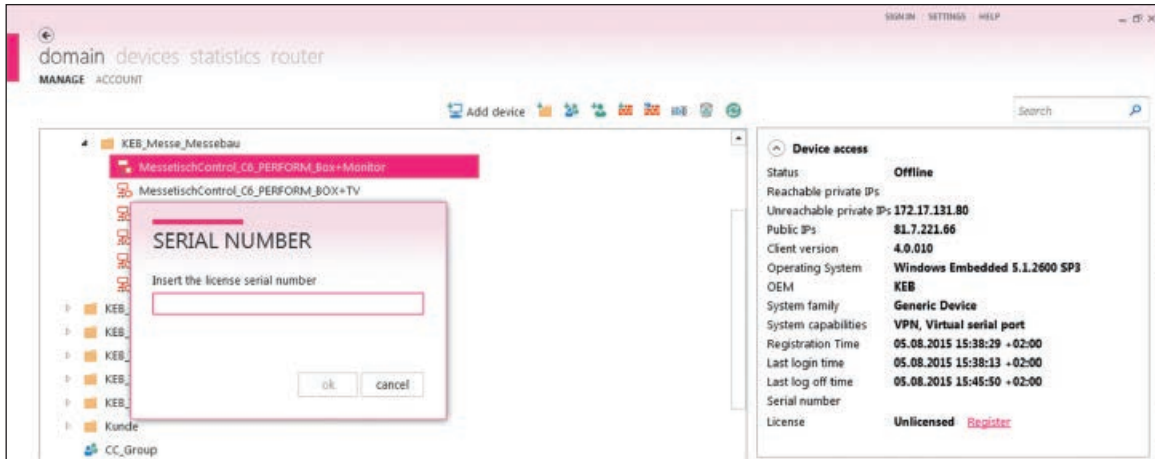

FILE EXCHANGE WITH REMOTE DEVICES

Thanks to the Remote Explorer Control Center function, a complete tool is available for downloading and uploading of files. This brings the benefit that access to the directories of the VPN partner need no longer be granted separately. Additional applications such as FTP servers are also no longer required.

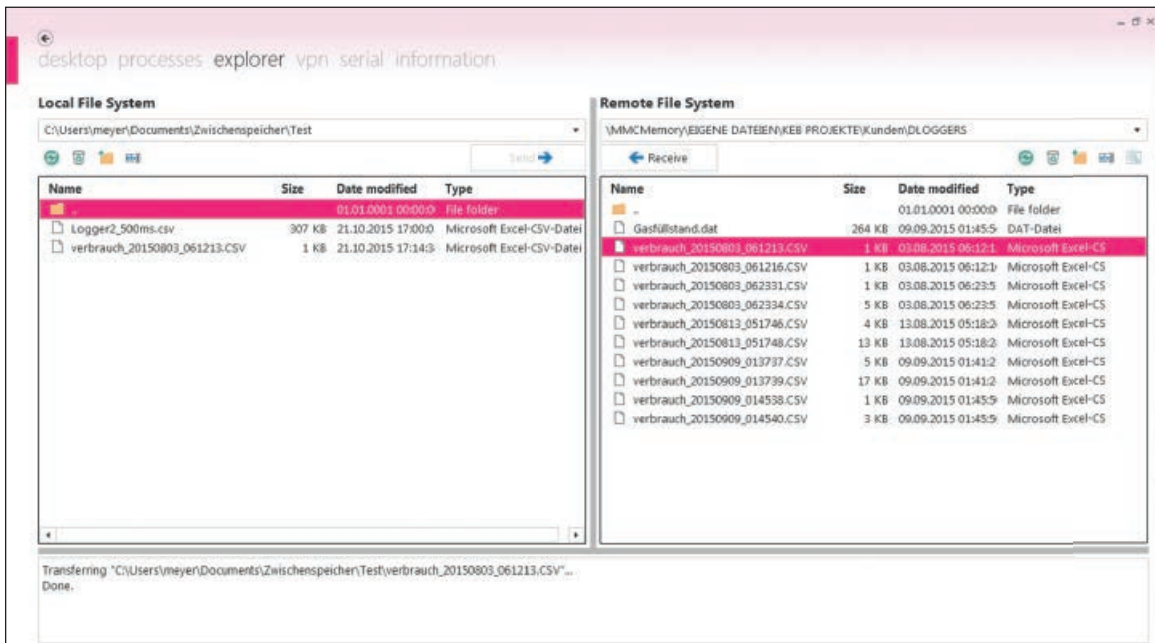

TARGETED REMOTE MAINTENANCE ACTIVITIES

Monitoring and start-up of remote devices

Access, fault search and programming of controls and automation devices

Preventative and predictive maintenance

Updates and changes of software applications on remote controllers

Access to Ethernet and serial subnetworks

SUPERIOR REMOTE MAINTENANCE FEATURES

Available for Win 32 and Win CE platform
 No additional hardware required
 Uses the existing Internet connection
 Remote PCs need no further services (VNC, FTP server, etc.)
 Simple and user-friendly interface, simple setup
 SSL/TLS protocol, encryption and certificates
 Safe and fast thanks to end-to-end VPN
 Automatic connection to first free relay server with shortest waiting time
 Multi-client Runtime

INNOVATIVE FUNCTION PROPERTIES

Remote desktop with multi monitor support
 Remote explorer
 Chat, screenshot, task manager, statistics
 VPN to remote PC
 VPN with access to the Ethernet subnetwork of remote devices
 Virtual serial interface
 Domain creation, hierarchical profiling of users and remote PCs
 Automatic connection creation after restart of remote PC
 Rights allocation for users and user groups
 Assignment of firewall rules at folder and device levels

COMBIVIS CONNECT RUNTIME

Remote desktop (also multiple sessions with Windows Server),
 file and task management, chat, screenshot
 VPN to remote system
 VPN with access to Ethernet of remote system
 VPN with access to subnetwork of remote system serial interface
 Integrated firewall
 API for interface with in-house software applications
 Permanent log Runtime operations
 Multiple connection of different control centres
 Creation of domain, structured organisation of users and remote PCs
 Support for Internet connection via PROXY for Control Center and Runtime
 Operation in local network without licence
 Support for control of Runtime with automatic management of termination and restart of Runtime service



HIGHLIGHTS

- Certified security according to IEC 62443
- Direct file exchange between local PC and remote device
- Ethernet and/or serial connection between local PC and remote device via VPN
- Integrated COMBIVIS connect firewall for communication through VPN / full compatibility with existing firewalls
- Multi-client functionality supports several simultaneous connections of different observers
- Management of access rights for an unlimited number of users and devices
- Recording of access activities in statistics



KEB



COMBIVIS CLOUD FUNCTIONALITY

In industrial environments, the fast and reliable acquisition, storage and analysis of field and plant data are becoming increasingly important. Large amounts of data have to be recorded permanently and stored reliably and securely. Cloud services are scalable and secure platforms that enable access to data from any location. The data can be prepared and made available comprehensively by appropriate services.

CLOUD INTERFACE



COMBIVIS CLOUD forms the interface to transfer data securely into a cloud solution. This icon is placed on the available hardware.

COMBIVIS CLOUD

EXTENSION FOR INDUSTRIAL CLOUD SOLUTIONS

With COMBIVIS cloud KEB offers a software solution to transfer process data securely into a cloud. Manufacturer-independent variables can be collected and stored. The data logger and storage functions of the COMBIVIS HMI platform are extended by connecting a cloud interface.



HIGHLIGHTS

- Data logger (with offline function)
- Cloud agent (store-and-forward procedure)
- Secure data transmission
- Standard protocols MQTT, AMQP
- Compatible with a wide range of cloud solutions
- Integration of cloud routers into existing systems
- Cloud Router optional with integrated modem

KEB SOLUTION

INTERFACE

EXTERNAL SOLUTION

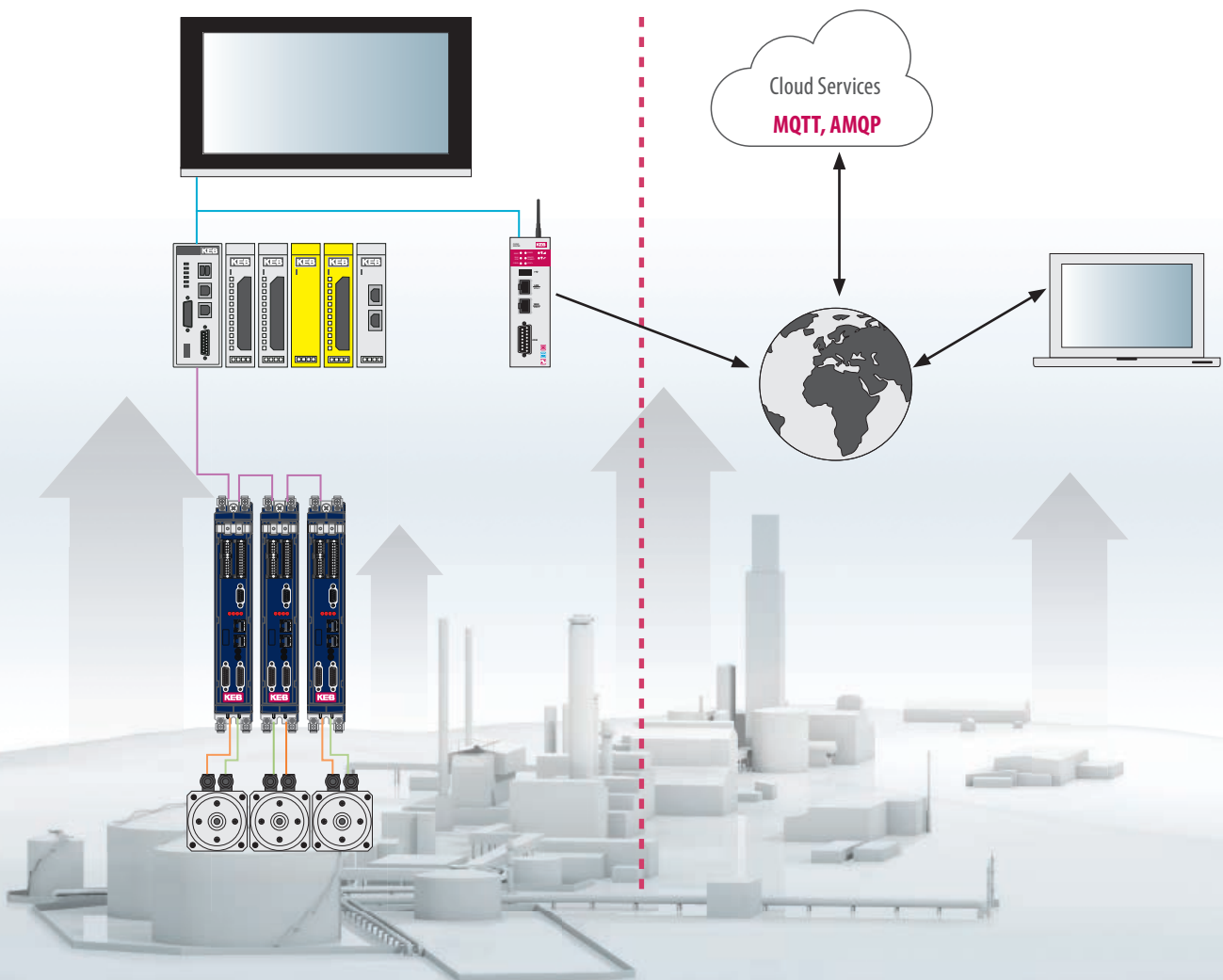

DATA LOGGING



In the process of a machine or plant, numerous data can be generated which are recorded by sensors or provided directly by components. The COMBIVIS HMI Runtime has a data logger to record specific data.

DATA TRANSMISSION



With COMBIVIS cloud KEB provides the interface to an external cloud solution. Using the COMBIVIS cloud functionality, the recorded data can be securely transferred to a stored cloud account.

The implemented store-and-forward procedure allows the reaction to connection gaps by a local buffering of the data in order to avoid data loss. The standard protocols MQTT or AMQT are used for transmission to support a wide range of cloud solutions. The data can be further processed by selecting different cloud services from the respective service provider.

CLOUD ROUTER

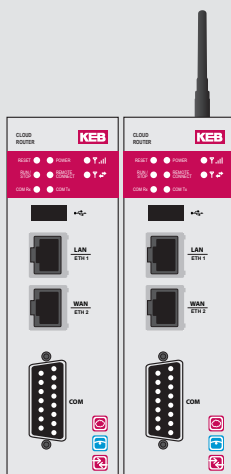

The C6 Cloud Router is a system consisting of COMBIVIS HMI and COMBIVIS cloud which can optionally be expanded with COMBIVIS connect. The system acts as an edge device in modern industry 4.0 architectures. Different variants of the Cloud Router are available and can be selected according to requirements.

TECHNOLOGY SOLUTIONS



KEB



TECHNOLOGY SOLUTIONS

By using special kernels and libraries, a solution can be found for almost every challenge. KEB provides

- Open tools for automation
 - COMBIVIS studio 6
 - COMBIVIS HMI
 - COMBIVIS connect
- Optimally matched hardware and software components
- Certified safety function blocks
- Industry-standard libraries and applications
- Scalable control, drive and motor solutions



















CNC SOLUTIONS



SMOOTH INTEGRATION

A consistent concept is essential to provide a complete CNC solution including matching hardware and software components. Starting at the control based on an IPC and the appropriate visualisation up to drive controllers with integrated safety, motors and gearboxes. Depending on the system design, suitable CNC solutions can be selected.

- CNC Visualization
- Entry-Level Solution
- High-End Solution

	C6 S14/SMART 	C6 E22 	C6 P33 	C6 P34 
CPU	Cortex-A9 iMX6, 1 GHz (2Core)	Intel Celeron J1900, 2 GHz (4Core)	Intel® Celeron G3955U, 2 GHz, (2 cores)	Intel Core i5-6440EQ 2,7 Ghz (4Core)
CNC Entry level	●	●	●	●
CNC High End	—		—	
CNC Visualization				
PLC				
Remote maintenance				

CNC ENTRY-LEVEL



A complete system including hardware and software package, is available for CNC application. In addition to the CNC core for movement of the interpolated axes, it contains the complete visualisation, which is very comfortable for the user. The surface of the HMI is designed for an intuitive using and features a lot of benefits to execute the CNC application.

Standard tools and languages allow the machine to be operated for example by personnel with varying knowledge levels. The associated Human-Machine Interface ensures simple access and facilitates maintenance. In addition, the solution is ready for Industry 4.0 / IIoT using the remote maintenance platform COMBIVIS connect and COMBIVIS cloud.

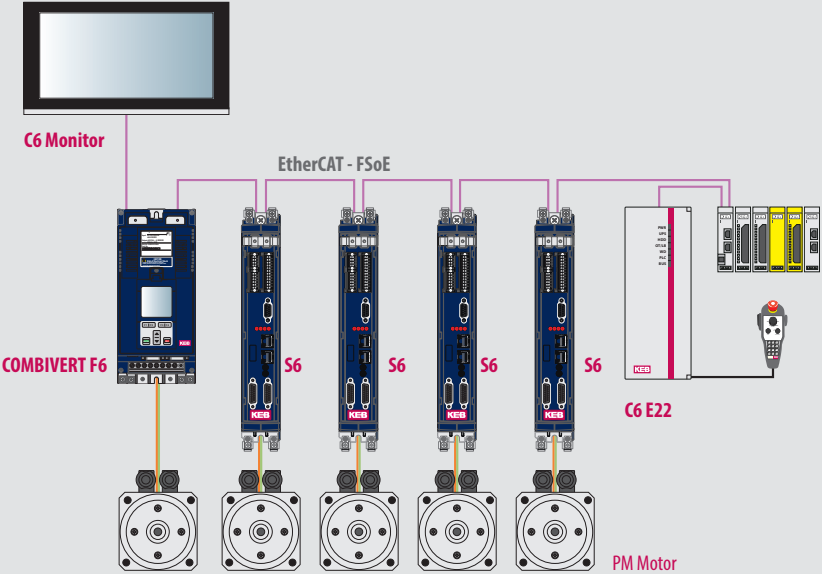

CNC SOLUTION WITH KEB KERNEL

The flexible and scalable system solution with integrated KEB CNC kernel consists of control, visualization, safety technology, drives and motors. It enables various applications in the field of CNC.

- Up to eleven interpolating axes in the Cartesian coordinate system
- No limit for non-interpolating axes in the bus network for all scaling in the CNC program
- Scalability of CNC controllers
 - Embedded controls as an economical solution
 - IPC technology for higher demands on cycle time
- Orientation at the Tool Center Point (TCP) as standard
- IEC 61131 programming environment for implementation of machine-specific functions
- Large number of interfaces for access to all information and customer-specific operation of the machine

The time-optimized commissioning of the CNC kernel takes place in four simple steps:

- Definition of kinematics used
- Parameterisation of CNC settings
- Registration of axes
- Creation of variables for exchange in G-code (optional)

These settings and extensions are based on standards according to IEC 61131-3 and DIN 66025. In addition, further G-code commands can be integrated and edited as well as subprograms retrieved in the G-code. Furthermore, the CNC kernel supports mathematical and logical expressions as well as string operators.

KEB_CncKernel	
InverterEnable	InitDone
ManualInterfaceIn	Progress
Reset	ProcessTime
AutoPause	ActGcodeFile
StepPause	ActGcodeLine
StartAutomatic	DistanceToGo
StopAutomatic	TargetDistance
ResetAutomatic	ActVelocity
ResetToolChange	RetractState
SetCncMode	AxisPowered
SetCoordinateSystem	AxisInMotion
GCodeFile	AxisHomingDone
SearchSetup	SpindleState
FeedOverride	ManualInterfaceOut
SpindleOverride	ActCncMode
StoreSettings	ActCoordinateSystem
CncSettings	RequestedTool
CoordinateSystemList	ActTool
Tools	ActToolCorrection
ToolCorrection	ToolChangeActive
	Error
	ErrorID
	ErrorStr
	ToolErrorID
	ActPosAcs
	ActPosMcs
	ActPosWcs

CORE FUNCTIONS OF THE CNC SOLUTION

- Manual/automatic mode
- Macros (WCS calibration function)
- M/T/S command functions

The type and scope of the CNC kernel can be adjusted according to the required kinematics. It works by default with the orientation at the tool center point (TCP). In the CNC kernel up to eleven interpolating axes in the Cartesian coordinate system can be worked with. Depending on the selected kinematics, several axes are connected in a group.



HIGHLIGHTS

- Integrated KEB CNC kernel
- Simple and flexible configuration
- User-friendly HMI
- Easy machine software realization
- Extension of machine functions via IEC 61131
- Time- and cost-optimized
- Safety

Examples of applications

- Milling
- Grinding
- Cutting

CNC HIGH-END



COMBIVIS studio 6

Automation tool with object-oriented design



High-end solution

KEB extension package

FAST AND PRECISE PATH PLANNING

For complex requirements, the high-end solution with the integrated ISG CNC kernel offers extensive features for CNC, robotics and motion control. Systems with up to 64 axes are possible for the realization of a CNC application. Depending on the requirements, the number of axes or channels can be increased. Extensive function packages are available for this purpose. The user has the possibility to access on a database with various transformations.

The interpolation can be linear, helical or spline interpolation. The aim is to achieve a stimulation-free and jerk limited motion control. In addition, KEB's CNC solution supports the possibility of volumetric compensation according to ISO 230. The system achieves its high precision by various compensation possibilities of mechanical and thermal influences.

OPEN TOOLS

KEB enables CNC machine manufacturers to automate their machine technologies with open automation tools based on standards (IEC 61131) without limiting the CNC functionality. This allows machine manufacturers to create their individual solution on demand. The system is set up using the COMBIVIS studio 6 automation tool – flexible and user-friendly. The object-oriented design of the tool supports the user in configuring the axes and channels.

CNC SOLUTION WITH ISG KERNEL

To enable the high end application, the CNC kernel was implemented on real-time capable IPCs. The solution is flexible and scalable in performance consisting of control, visualisation, safety, drives and motors to allow a lot of applications in the area of CNC. The range of function gives solution for tool machines as well as moving of complex kinematics. The functions are used, for example, in applications such as milling, drilling, cutting, grinding, bending and associated handling systems.

The comprehensive functionality with excellent path and speed planning as well as the architectural model on which the software is based are the essential characteristics. The last point is enabling next to continuous extension for technologies and functions the adjustment of individual customer requirements.

BASIC PACKAGE

The basic package of the high-end solution offers essential CNC features. These are among others:

- Speed and acceleration pre-control, jerk limitation
- Powerful, clock-synchronous CNC-PLC interface
- Coupling functions, gantry axis functions, measuring functions
- Look-ahead function
- Linear, circular, spiral interpolation
- DIN 66025 program syntax with high-level language extension
- Subprogram technology, macro definitions, coordinate systems, spindle and additional functions
- Operation with automatic mode, manual mode, single block mode, referencing, block advance, handwheel operation mode
- Tool management

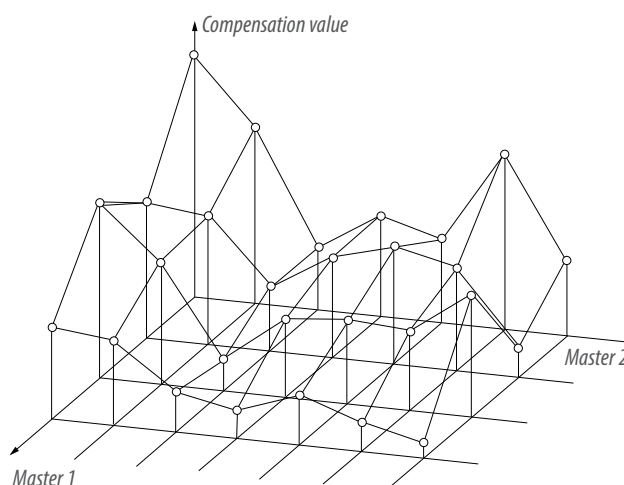

EXTENSIVE FUNCTION PACKAGES

Building on this, extensive function packages are available for the implementation of various applications. The packages can be selected according to the requirements and the software can be extended by the necessary functions:

- **CNC Channels:** Up to 12 channels expandable, channel synchronization, axis exchange between the channels
- **Transformation:** Expansion of all CNC channels through kinematic transformation
- **High-Speed Cutting (HSC):** Faster processing time, higher accuracy, better surface quality
- **Spline:** Use of gearing (AKIMA, B-Spline) for geometry optimization
- **Cutting:** CNC technology extension for cutting (e.g. laser, plasma, oxyfuel, water jet)
- **Volumetric compensation:** Effective way to increase machine accuracy

CNC HIGH-END

CHANNEL (EXTENSION WITH EACH ONE CNC CHANNEL)

- In general up to 12 channels: 1 base + 11 channel
- Channel synchronisation
- Axis exchange between the channels
- Cycle depending interfaces between the channels (e.g. dynamic coordinate system)

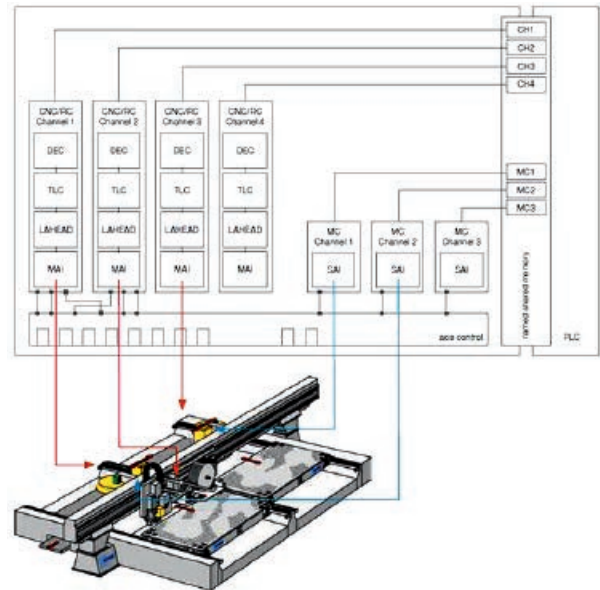

TRANSFORMATIONS

Expansion of all CNC channels through kinematic transformation

- 5-axis functionality
- Rotating tool center point (RTCP)
- Selection of kinematics from a kinematics library
- User-specific extensibility (depending on the system environment)
- Tool length compensation (TLC)
- Tool alignment according to the active coordinate system
- Definition and programming in different coordinate systems,
- Linking transformations

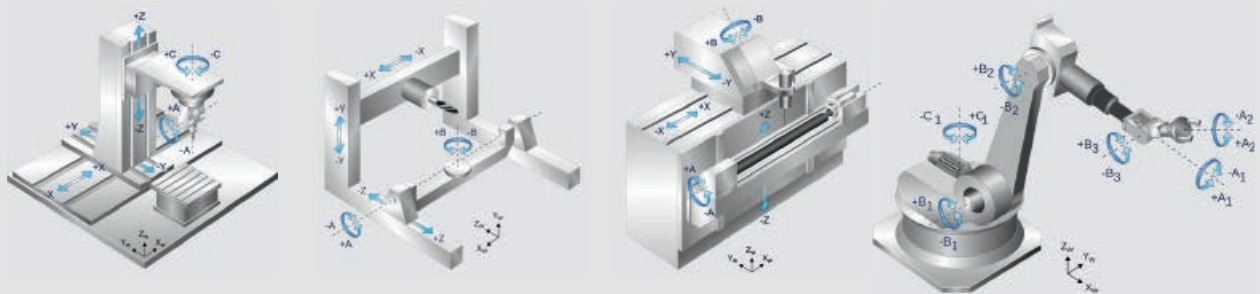
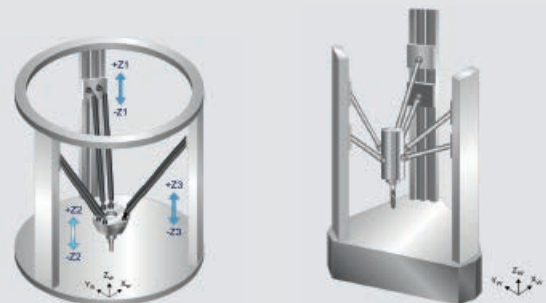

CUTTING

CNC technology extension for cutting (e.g. laser, plasma, oxyfuel, water jet)

- Automatic lifting and lowering of an axis
- Cross block lifting to avoid collisions of the tool head with cut-out workpiece parts
- Jerk limited speed profile without disturbing influence on the path speed
- Microsteps, fast laser switching signals
- High-resolution M functions (1 μ s), time stamp
- Different types of synchronisation
- Extended M-function output for creating microtracks
- pipe transformation
- Support of different profiles, polygon tubes and profile tubes
- Unwinding of the programmed contour on the side surface of the profile.

HIGH SPEED CUTTING (HSC)

- Optimization of geometry: spline, HSC mode, contour smoothing (Smart Surface), tool compensation
- Jerk-limited, moderated and time-optimized acceleration profiles
- Model-based cascadable filters (HSC and axis filters)
- Motion state controlled output of control signals to the PLC
- Real-time variables of the PLC or control technology for process control

SPLINE

Use of spline (Akima, B-Spline) for geometry optimization with definable tolerances.

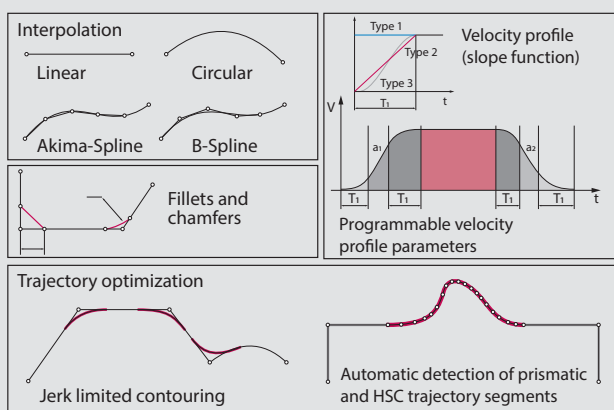

Path generation functions

VOLUMETRIC COMPENSATION

Volumetric compensation can be used for all machines that can be described by a serial kinematic with exactly three linear axes X, Y, Z and up to three rotary axes A, B, C. Gantry combinations are supported (transparent to the user) by providing the slave axes with the same compensation values as their master axes.

- Effective way to increase machine accuracy
- Tool center point correction (TCP) through dynamic determination of axis correction values
- Can be used for different kinematic arrangements (head/table kinematics)
- Multiple parameter files per compensation, multiple compensations per controller
- Parameter update via NC command or HMI
- Interpolation of parameter sets
- Smoothing parameter jumps for module passes
- Configurable limitation of the compensation values and extension speed
- Supported file formats (tabular CSV format, Etalon exchange format)
- Standards (DIN ISO 230 „Test specifications for machine tools“)
- ISO/TR 16907 „Machine tools - numerical compensation of geometric errors“.

COMPENSATION EXAMPLES

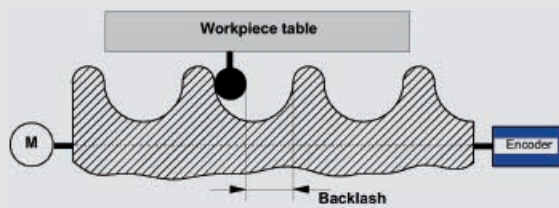

backlash compensation

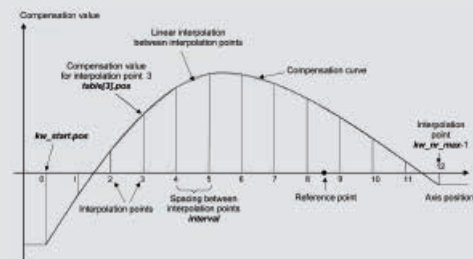

leadscrew error compensation

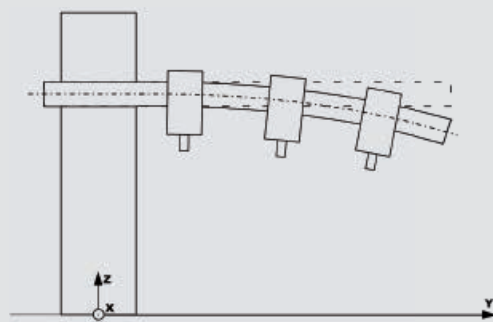

beam sag compensation

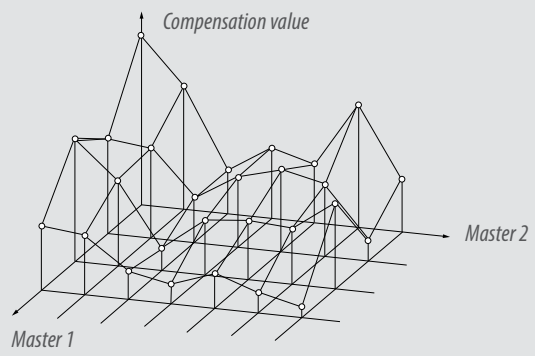

alignment error compensation

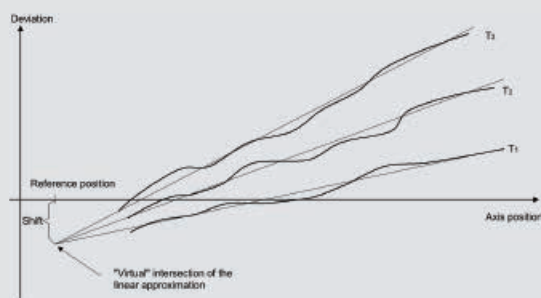

temperature compensation

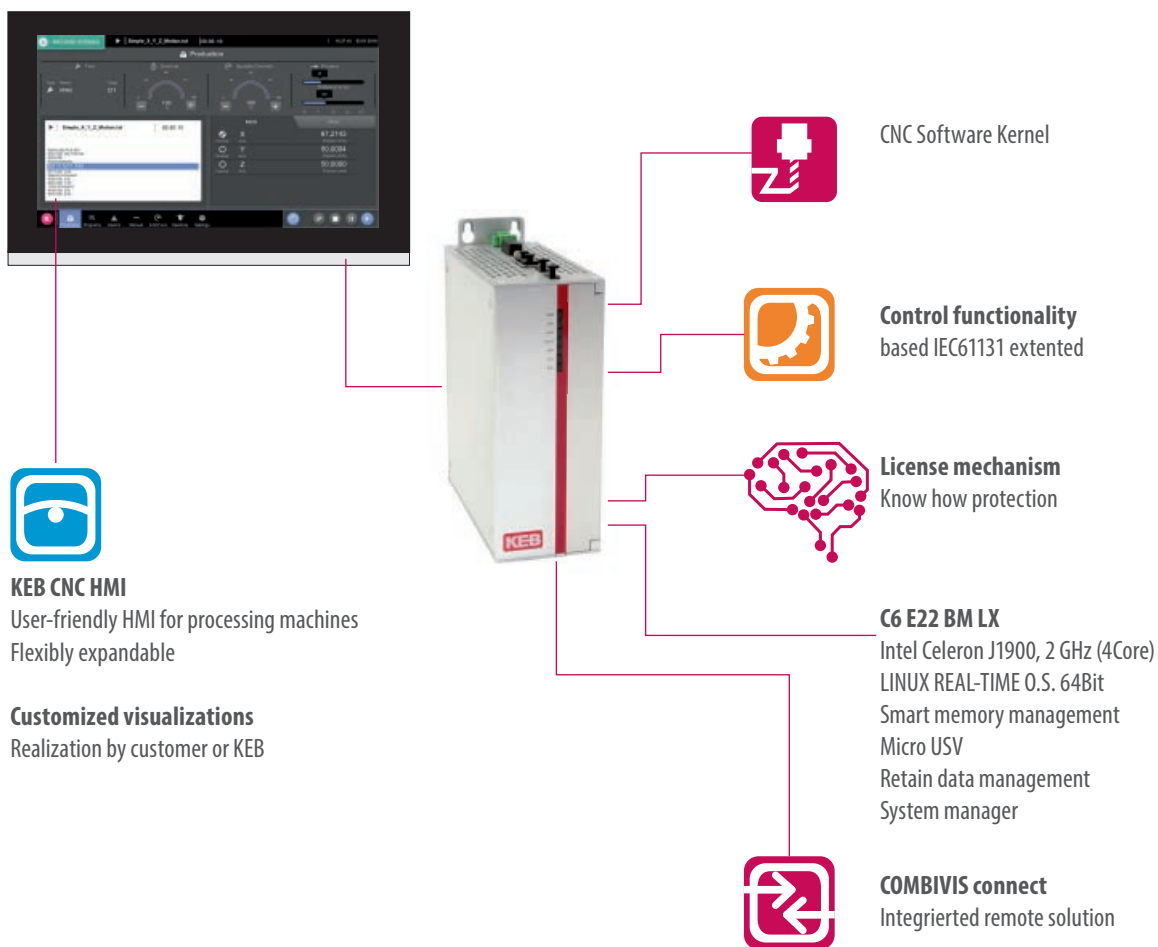

HIGHLIGHTS

- Integrated ISG CNC kernel
- Simple and flexible set up with object-oriented design in COMBIVIS studio 6
- Extension of machine functions via IEC 61131 without limiting CNC functionality
- Extensive function packages
- Safety
- Advanced features for CNC and robotics
 - Compensation axis / temperature
 - High speed cutting
 - Look-ahead function
- Multi-Core management

CNC VISUALIZATION



The CNC solutions contain the complete CNC visualization in a user-friendly interface. The HMI interface is designed for intuitive operation with multitouch and offers convenient features for the operation of CNC applications. The associated commissioning wizard guides the user from the reference point run to the determination of up to 100 zero points of the workpiece and, if necessary, machine coordinate systems to the parameterization of the CNC program and all necessary machine settings. This enables even users with less experience to start a machine program without any problems. In addition to operation via the capacitive touch screen, classic operation via mouse and keyboard is also possible.

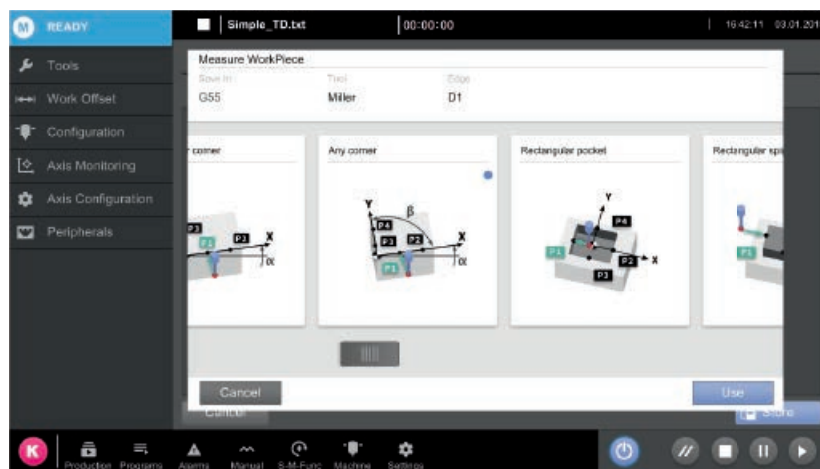

The change between the workpiece coordinate systems takes place „On the fly“.

Work piece coordination system

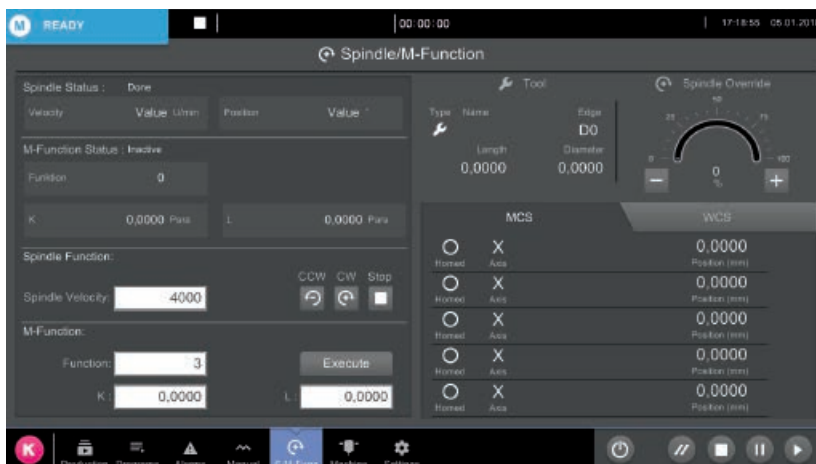

Spindle management

The spindle management is integrated in the kernel.

Start / Stop Forward and reverse are controlled by M functions. The angular position of the spindle can be interpolated with the axis. This function requires a spindle motor with speed and position feedback. In addition, the spindle can be operated manually via the HMI.

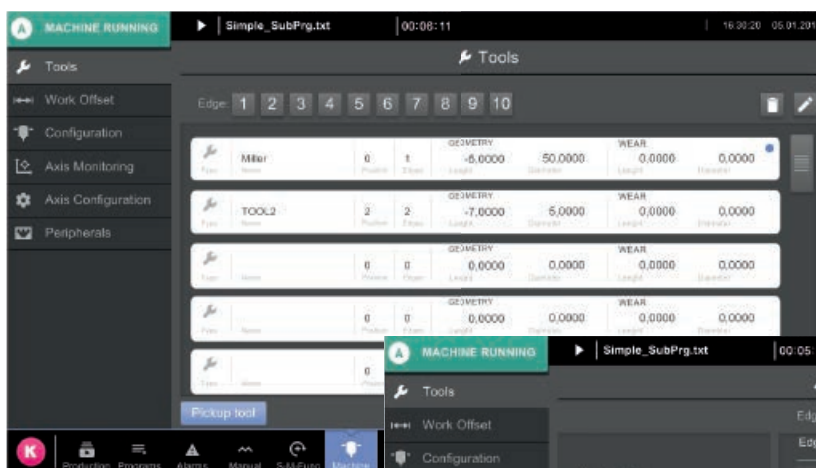

Tool management

Up to 100 tools can be created. The generated database can be saved and exported for further use. You can calibrate each tool individually (e.g. number of cutting edges of tool)

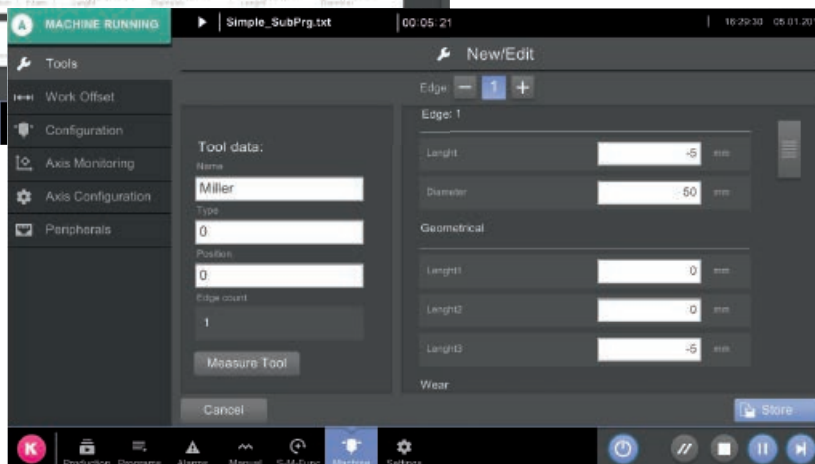

HIGHLIGHTS

- Setup assistant
- Flexible expandable
- Customers visualization
- G-Code editor
- Tool management
- Direct storage of tool datas
- Spindle management
- Management of machine- / work piece coordination system
- Handling tool changer
- Contouring setup

EXTRUDER SOLUTIONS

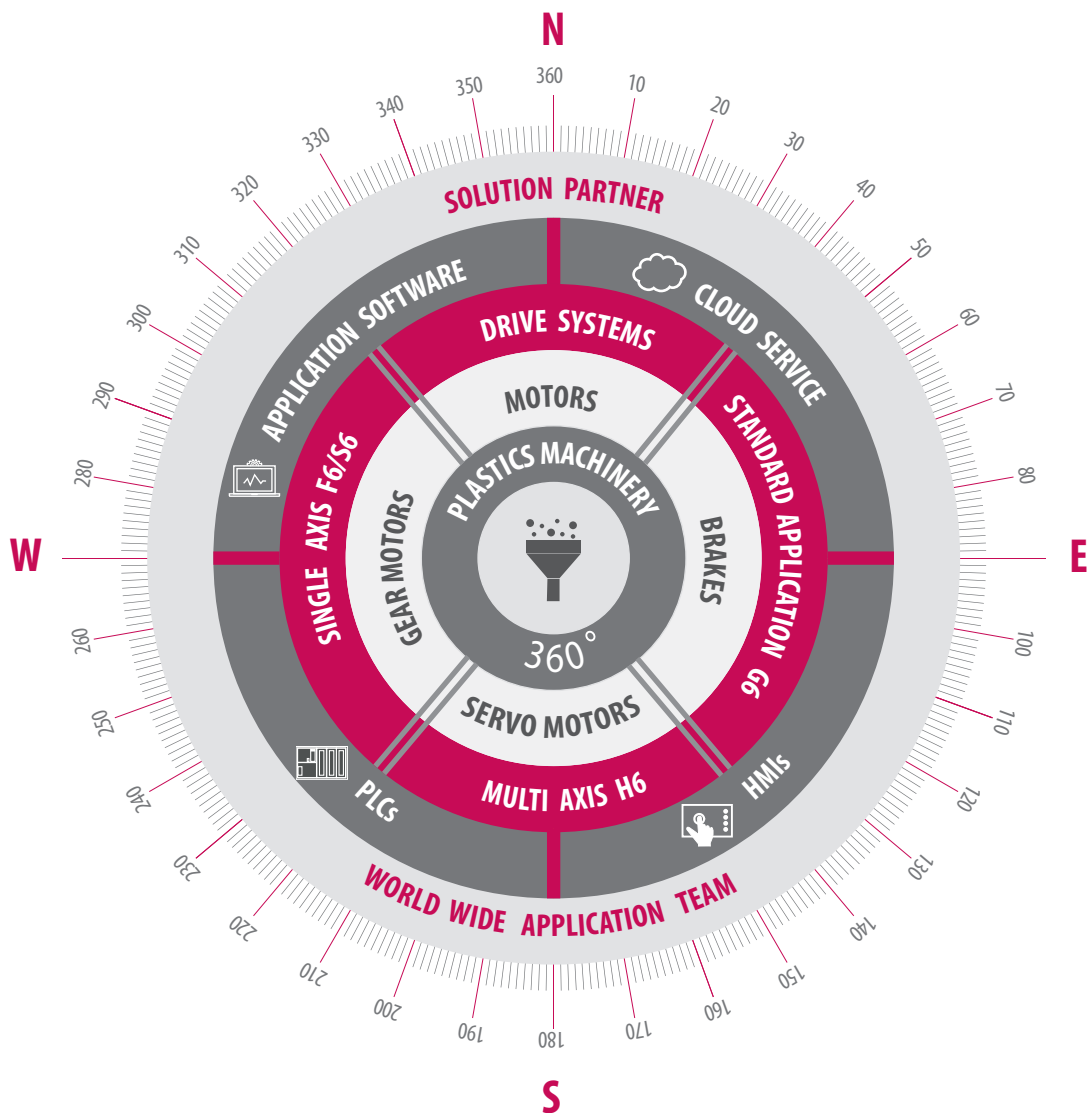

PRECISION, PERFORMANCE AND QUALITY

Precision, performance and quality - the strengths of our systems are particularly evident in plastics machinery, one of our main application fields. They are complemented by our worldwide service, a global application team and more than 20 years of experience in plastics applications.

Today, our portfolio offers individually coordinated 360° solutions – starting with the software including a cloud solution, through the HMI and PLC, right up to the Drive Controller. The system is rounded off by servo motors and gearmotors with matching permanent magnet brakes.

From our wide portfolio, the team for plastic applications creates a solution tailored to your requirements. The KEB Automation Group is internationally positioned and achieves an optimal result for your machine through a continuous exchange with you. We accompany the process from the idea through development and commissioning up to the after sales service.

EXTRUSION TECHNOLOGY



HMI

Modern HMI with many ready-made functions



CONTROLLER TUNING

Specially developed controllers with auto tuning function



FUNCTION BLOCKS

Ready-made function blocks for extruder application



THE COMPLETE SOLUTION FOR YOUR SUCCESS

For the complete automation of an extruder line, KEB offers an extensive project framework, that allows to operate the extruder itself as well as the auxiliary drives – from the newly developed extruder software, which is perfectly matched to the performance of our control technology, via the drive controller right up to the motors.

Our portfolio enables the user to create a complete solution for his machine. The extruder solution can be optimally adapted to the requirements of the customer's machine, both in terms of software and hardware.

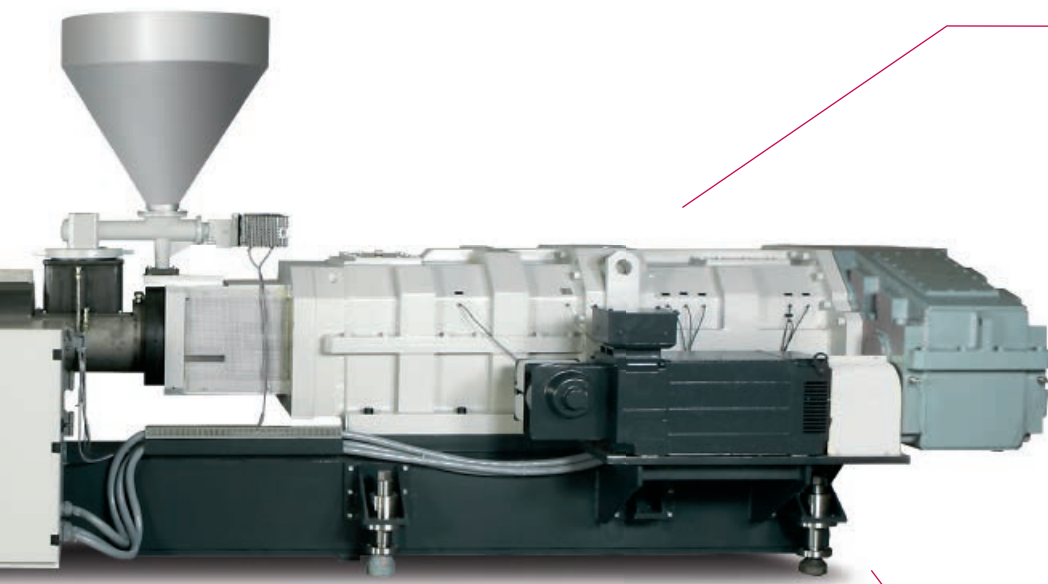

EUROMAP

Compliance with Euromap 84 and 83 standards



OPC UA

OPC UA

Interface for OPC UA

MOTOR TYPES

Various motor types (IPM, SynRM, SM, ASM)



EXTRUDER SCREW DRIVE

KEB has more than 20 years of experience in the field of the main drive of an extruder. The Drive Controllers are characterized by encoderless controlled operation with high speed stability and precise torque calculation. In addition, a wide range of motor types can be operated. Finally, among many cooling systems the right one can be chosen. With the new DL4 motor series KEB is now offering motors in the higher power range. Together with the drive controllers, they provide a very good performance.

In combination with the extruder software, the screw can easily be operated in different modes, such as pressure/speed control. Furthermore, a lot of drive and motor information is already appealingly displayed in the HMI user interface.



EXTRUDER SOFTWARE

The extruder software features a modern HMI design and a basic control project with ready-made function blocks. Through the open solution, which is programmed in line with Euromap, you can enhance and individually design the control project and HMI according to your requirements.

PLC PROJECT

The PLC project framework provides the basis for the HMI user interface. According to IEC61131, this framework can also be extended individually. Thus you can integrate further machine functions with the KEB own software tool COMBIVIS studio 6.

The essential point of an extruder is temperature control. It is responsible for the quality in which the end product is produced. Therefore, the PLC software contains specially developed temperature controllers that are perfectly matched to the application. In addition, the tough controllers can be independently configured via auto tuning. This is also implemented in the integrated commissioning wizard. In order to extend the functions of the machine, KEB not only offers prefabricated modules for the extruder itself, but also considers the following devices, such as a winding device that can easily be programmed with one module. Depending on your performance level, you will receive the appropriate hardware for the software. From the PLC itself to remote maintenance and cloud connection, your machine is optimally equipped for the future in terms of industry 4.0.

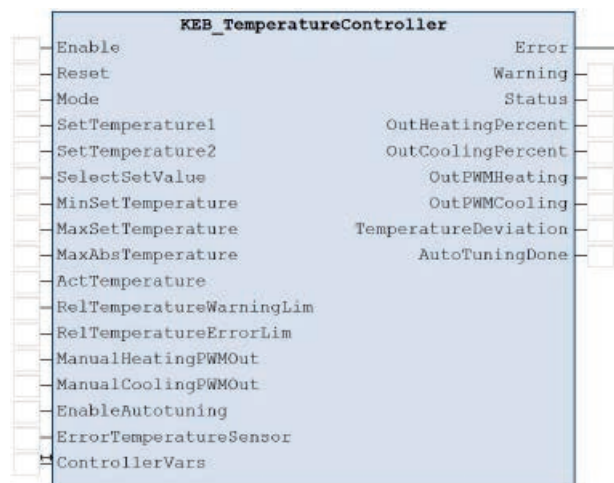



HMI SURFACE

In today's world of smartphones and tablets, a user-friendly HMI interface is more important than ever. The extruder HMI framework meets exactly these requirements. The framework provides a well-structured and appealing process visualization, which you can use if required. So it is possible to create your own business card for the machine from the HMI surface. Therefore KEB provides the software tool COMBIVIS studio HMI.

In addition to the process visualisation, the customer will find further prefabricated features that will save significant costs and time during the design phase. The framework includes a ready-made recipe management, extensive error handling and a long-term trend display. But also following devices such as a melt pump are already integrated in to the surface. The integrated commissioning wizard is a highlight. With this it is possible to put the machine into operation anywhere flexibly by any skilled person without programming knowledge. Furthermore, the size and type of extruder is irrelevant. It applies: One HMI surface for all extruders. After a unique learning process, the final customer can also quickly serve other extruder types and sizes.

Adapted to your needs, KEB provides the suitable HMI panel in the appropriate shape and size.

HIGHLIGHTS

- Extensive project framework to automate extrusion lines
- Perfectly coordinated hardware and software
- Special controllers for extruder applications
- Developed according to Euromap standards

OVERVIEW

	Display	4.3"	5.7"	7"W	8.4"	10.1"W	10.4"	12.1"	12.1"W
	Format	16:9	4:3	15:9	4:3	16:10	4:3	4:3	16:10
	Resolution	480 x 272	640 x 480	800 x 480	800 x 600	1280 x 800	800 x 600	800 x 600	1280 x 800
	Design								
C6 HMI									
C6 HMI LC									
C6 S14									
C6 E22									
C6 P34									
C6 SMART									
C6 MONITOR									
C6 AMM									
C6 COMPACT									
C6 ROUTER									

CONTROL Is the basis for PLC and und Motion Control functionality.

Basic Basic function scope for the KEB automation platform (IEC 61131-3 standard and KEB Basic libraries)

Pro Professional function scope for the KEB automation platform (cam discs, electronic gears, angle synchronisation)

Advanced Advanced function scope for the KEB automation platform (CNC functionality, G-Code, prepared movements)

15"	15.6"W	17"	18.5"	19"	21.5"	24"W
4:3	16:9	4:3	16:9	5:4	16:9	16:9
1024 x 768	1366 x 768	1280 x 1024	1366 x 768	1280x1024	1920x1080	1920 x 1080

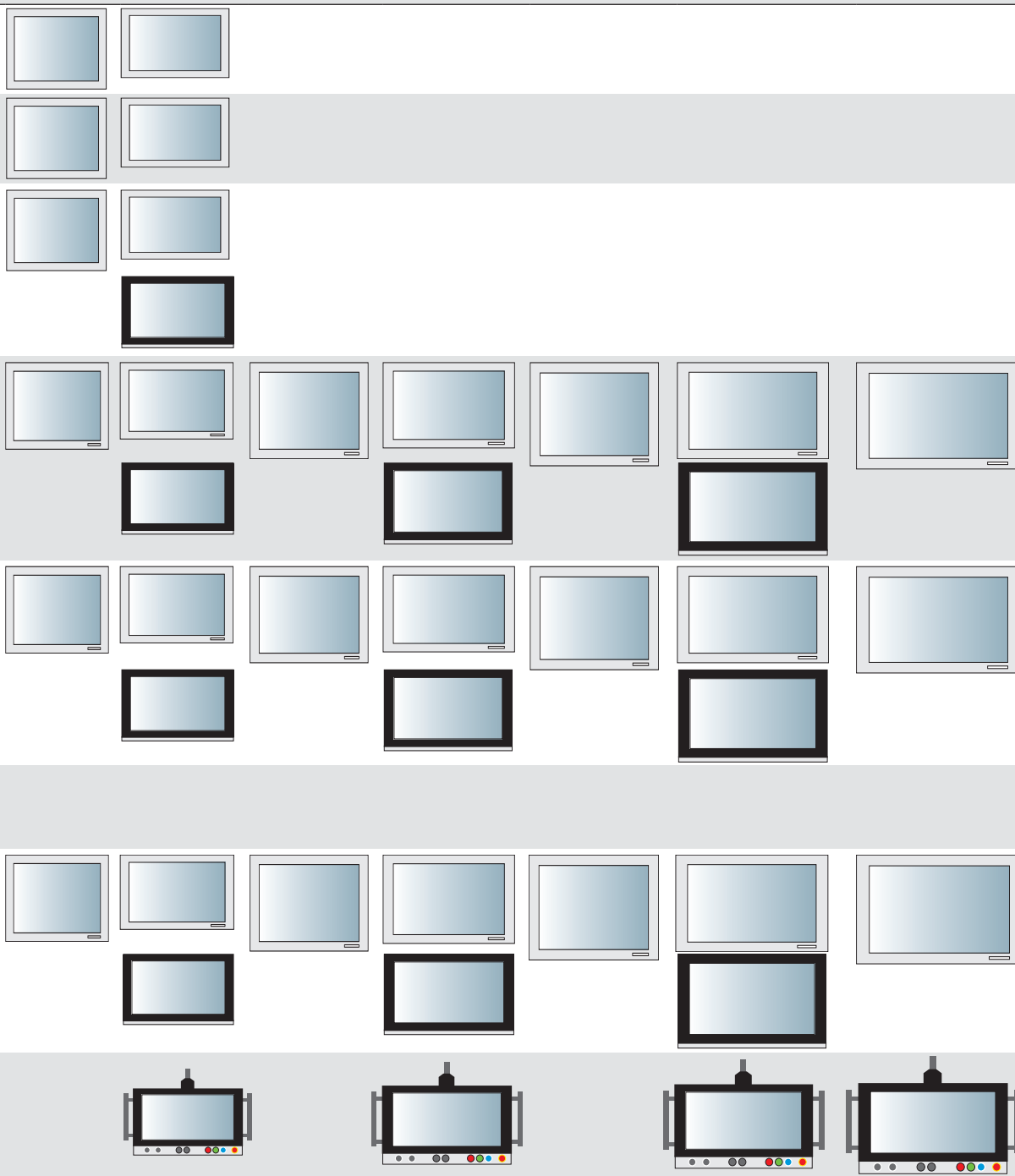

HMI Is the basis for visualization and operation tasks.

B Basic Basic function scope for KEB HMI

P Pro Professional function scope for KEB HMI
(extended real-time database, data logger)

A Advanced Advanced function scope for KEB HMI
(webserver, multidrivers, sms, email)

CONNECT Is the basis for professional remote maintenance

CLOUD Forms the interface to transfer data securely into a cloud solution

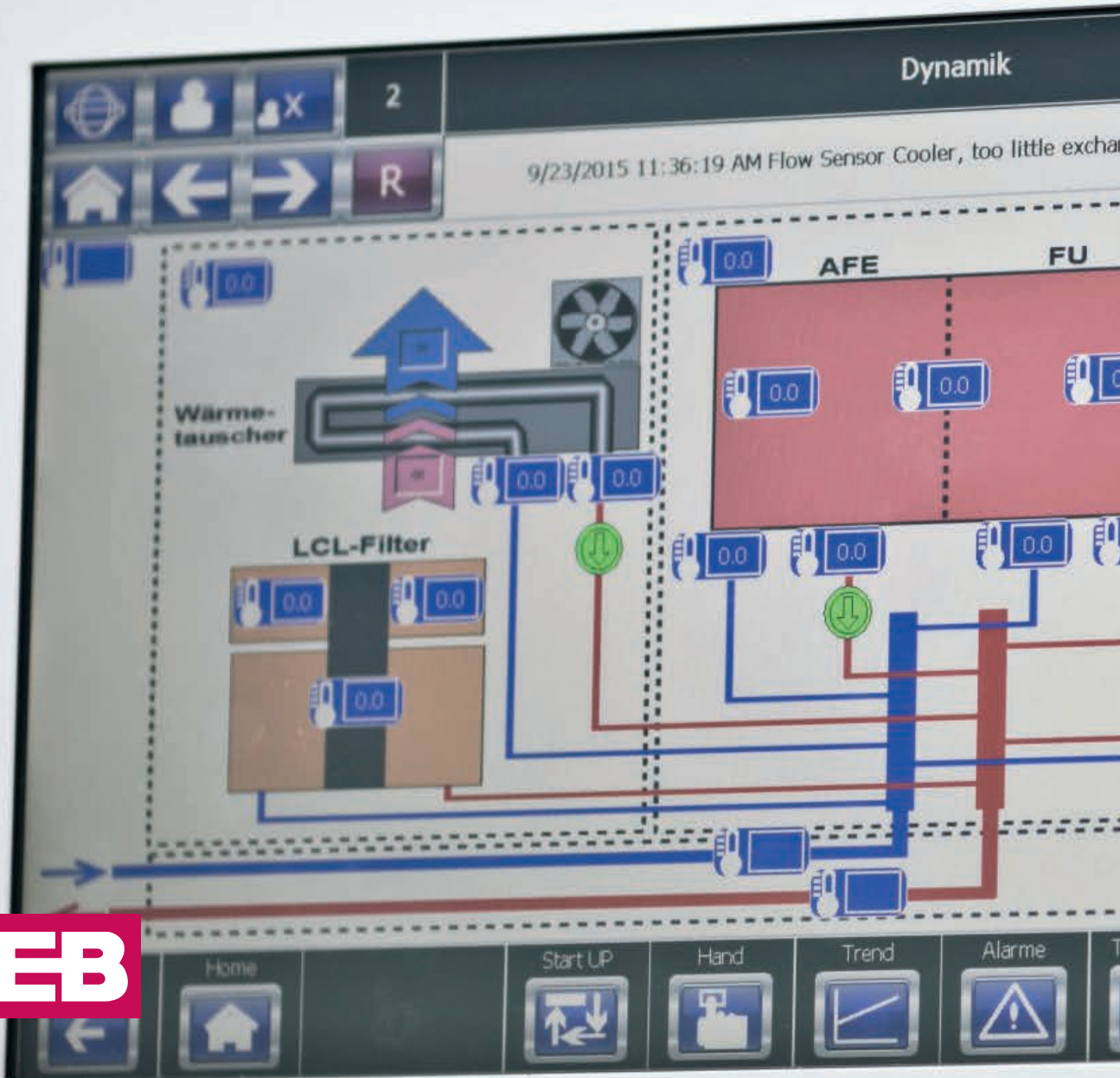

KEB

KEB

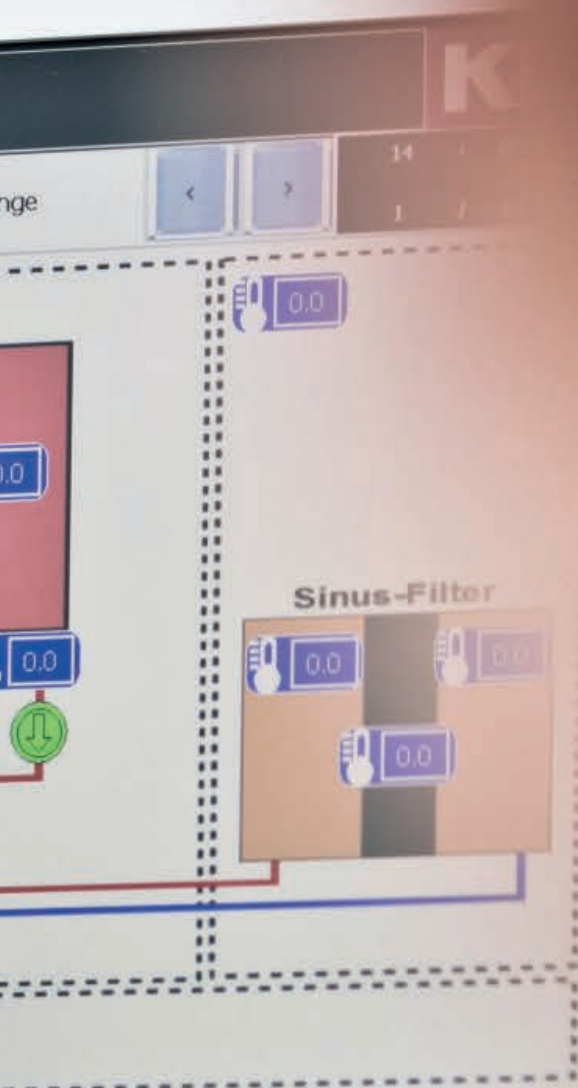

EMBEDDED TECHNOLOGY

An embedded system is a modular constructed and embedded control system, the computer architecture of which is based on a standard PC.

In this system, only components which are required for the corresponding application are integrated in the system. They are used where computing power and compatibility are required.

Ever more powerful processors allow the use of embedded systems to control complex machines and plants in real-time.

- C6 HMI
- C6 HMI LC
- C6 S14
- C6 SMART
- C6 COMPACT
- C6 SAFETY PLC
- C6 ROUTER

C6 HMI



HIGHLIGHTS

- High-quality visualization system
- Open and communicative thanks to multiple interfaces and drivers for widely varying controllers, drives
- Integrated remote maintenance
- Intelligent Memory Management with large internal memory

C6 HMI

PROTECTION CLASS IP66

4:3 AND 16:9 FORMATS



ALUMINIUM FRAME

TOUCH SCREEN

16 MILLION COLOURS

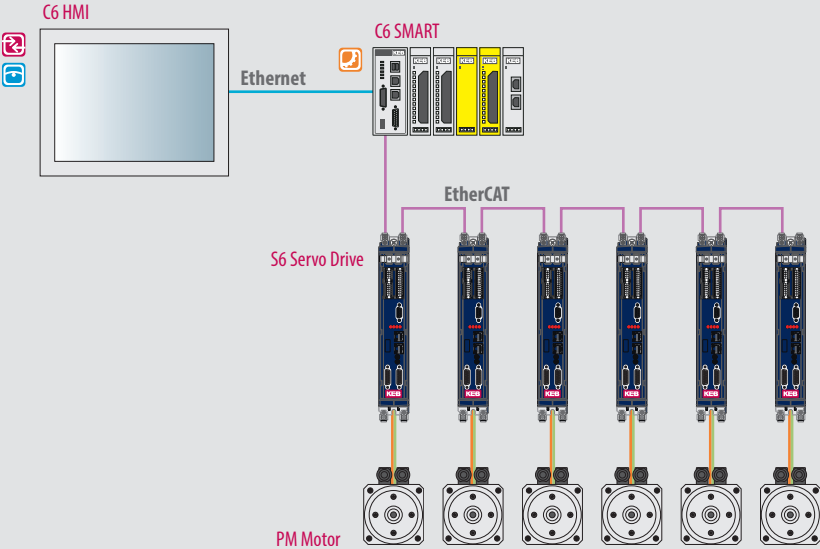

CPU

Processor	ARM Cortex A8 - Freescale i.MX535, 1 GHz, 400 MHz Memory Bus
System memory	RAM 1GB DDR3-800
Front panel	GPU with integrated LCD controller

MASS MEMORY

NAND Flash	256 MB for operating system and runtime environments (internal, not removable)
eMMC (Solid State Disk)	4 GB project memory for free use

OPERATING DATA

Power supply	18 . . . 36V DC (isolated power supply)
Operating environment	0 . . . 50°C, Rel. humidity 80% (without condensation)
Storage conditions	-20 . . . 60°C, Rel. humidity 80% (without condensation)

OPERATING SYSTEM

Windows Embedded Compact 7 Pro

APPROVALS

CE (EN 55022, EN 61000-3-2/3, EN 55024, EN 60950-1), cULus LISTED (UL508)

PANEL

Display size	4.3"W	5.7"	7"W	8.4"	10.1"W	10.4"	12.1"	12.1"W	15"	15.6"W
Format	16:9	4:3	15:9	4:3	16:10	4:3	4:3	16:10	4:3	16:9
Resolution	480x272	640x480	800x480	800x600	1280x800	800x600	800x600	1280x800	1024x768	1366x768
Colours	16 M	256 K	16 M	16 M	16 M	16 M	16 M	16 M	16 M	16 M
Brightness	400 cd/m ²	500 cd/m ²	500 cd/m ²	250 cd/m ²	400 cd/m ²	400 cd/m ²	500 cd/m ²	400 cd/m ²	450 cd/m ²	300 cd/m ²
Viewing angle (L:R/O:U)	130°, 90°	140°, 100°	140°, 120°	150°, 130°	160°, 160°	160°, 140°	160°, 140°	176°, 176°	160°, 140°	170°, 160°
Touch technology	Resistive 4 wire			Resistive 5 wire						
Protection class	IP66 On front									
Front panel	Aluminium. Polycarbonate									

C6 HMI

NETWORK-ON LED

USB 1 (TYP A 2.0)

LAN 2 (10/100 MBPS) (COMBIVIS CONNECT)

LAN 1 (100 MBPS)

COM 1 (RS232/422/485/MPI)

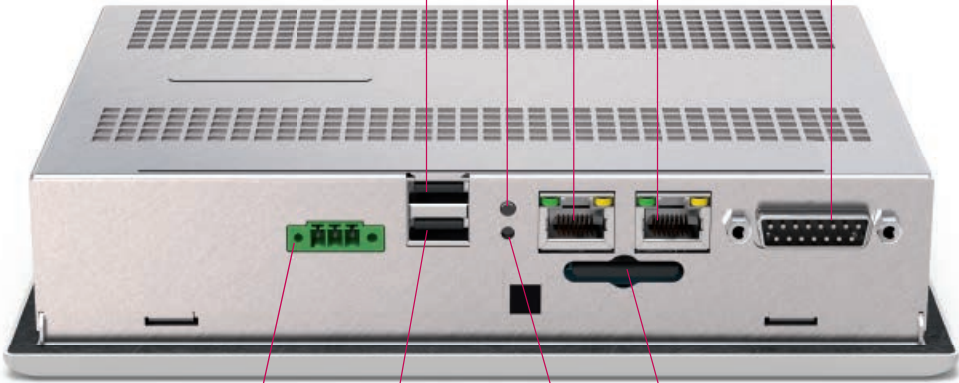

DC POWER SUPPLY

USB 2 (TYP A, 2.0)

SD CARD SLOT

RESET BUTTON

INTERFACES

Ethernet	1 x 100 Mbps (RJ45), 1 x 10/100 Mbps (RJ45), 4.3" only 1 x 10/100Mbps (RJ45)
USB on back	2x USB 2.0 (4.3" only 1 x USB 2.0)
Serial interface	1 x RS232/422/485 (DB15M) / MPI 187.5 kbit/s
SD/SDHC card slot	External access / removable V 2.0 (push-push type) from size 5.7"

PANEL SIZE	A	B	C	D	E	F	G	H	J	K	L	M	N
4.3"	140	95	5	30	–	5	–	84	–	–	128	131	86
5.7"	175	145	5	40	–	7	–	131	–	–	161	164	134
7.0"W	215	155	5	40	–	7	–	141	–	–	201	204	144
8.4"	255	190	5	19.5	29	7.5	15	130	30	42	156	243	179
10,1"W	293	201.5	5	19.5	29	6.5	15	130	43.5	62	156	285	193.5
10.4"	295	230	5	19.5	29	7.5	15	130	70	62	156	283	219
12.1"	325	260	5	19.5	29	7.5	15	130	100	77	156	313	249
12.1"W	321	222.5	5	19.5	29	6.3	15	130	65	76	156	313	215
15.0"	390	305	6	19.5	29	7.5	15	130	145	109.5	156	378	294
15.6"W	420	265	6	19.5	29	7.5	15	130	105	124.5	156	410	255

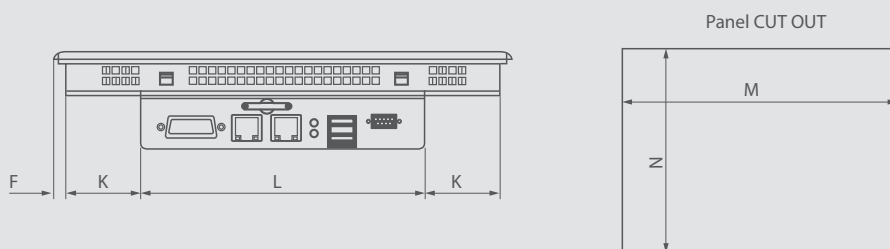
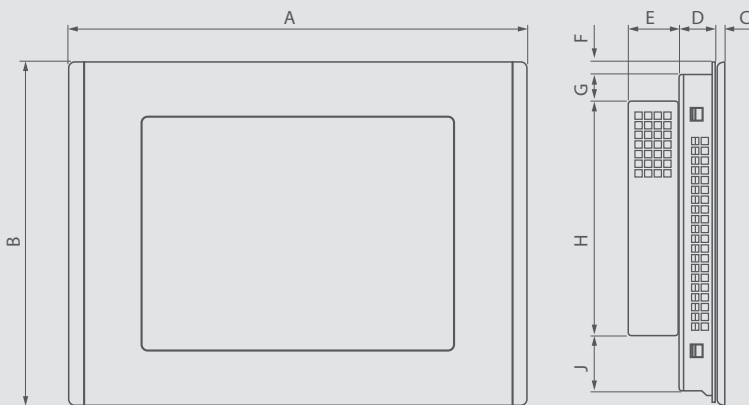

C6 HMI LC



HIGHLIGHTS

- All-in-one automation solution
- Controller with EtherCAT® master
- High-quality visualization
- Integrated remote maintenance
- Micro UPS for protection of non-volatile data
- Software tool for backup, restore and transfer of systems

C6 HMI LC

PROTECTION CLASS IP66

4:3 AND 16:9 FORMATS



ALUMINIUM FRAME

16 MILLION COLOURS

TOUCH SCREEN

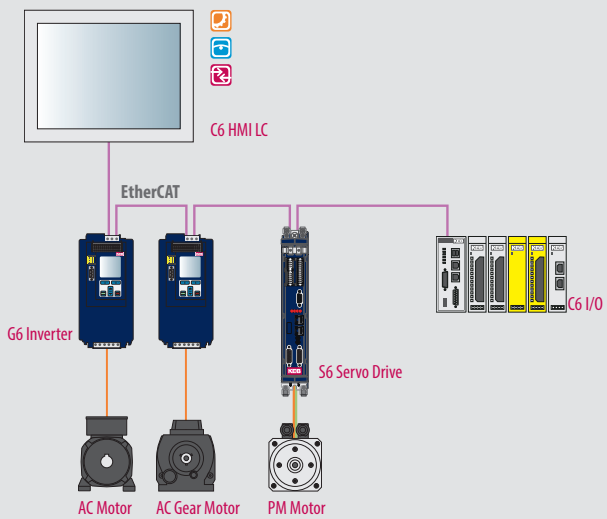
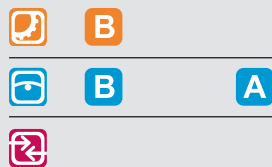

CPU

Processor	ARM Cortex A8 - Freescale i.MX535, 1 GHz, 400 MHz Memory Bus
System memory	1 GB DDR3-800
Graphic controller	GPU with integrated LCD Controller

MASS MEMORY

NAND Flash	256 MB for operating system and runtime environments (internal, not removable)
eMMC (Solid State Disk)	4 GB project memory for further free use

OPERATING DATA

Power supply	18 . . . 36 V DC (isolated power supply)
Operating environment	0 . . . 50 °C, Rel. humidity 80 % (without condensation)
Storage conditions	-20 . . . 60 °C, Rel. humidity 80 % (without condensation)

OPERATING SYSTEM

Windows Embedded Compact 7 Pro

APPROVALS

CE (EN 55022, EN 61000-3-2/3, EN 55024, EN 60950-1), cULus LISTED (UL508)

PANEL

Display size	5.7"	7"W	8.4"	10.1"W	10.4"	12.1"	12.1"W	15"	15.6"W
Format	4:3	15:9	4:3	16:10	4:3	4:3	16:10	4:3	16:9
Resolution	640 x 480	800 x 480	800 x 600	1280 x 800	800 x 600	800 x 600	1280 x 800	1024 x 768	1366 x 768
Colours	256 K	16 M	16 M	16 M	16 M	16 M	16 M	16 M	16 M
Brightness	500 cd/m ²	500 cd/m ²	250 cd/m ²	400 cd/m ²	400 cd/m ²	500 cd/m ²	400 cd/m ²	450 cd/m ²	300 cd/m ²
Viewing angle (L:R/O:U)	140°, 100°	140°, 120°	150°, 130°	160°, 160°	160°, 140°	160°, 140°	176°, 176°	160°, 140°	170°, 160°
Touch technology	Resistive 4 wire		Resistive 5 wire						
Protection class	IP66 On front								
Front panel	Aluminium. Polycarbonate								

C6 HMI LC

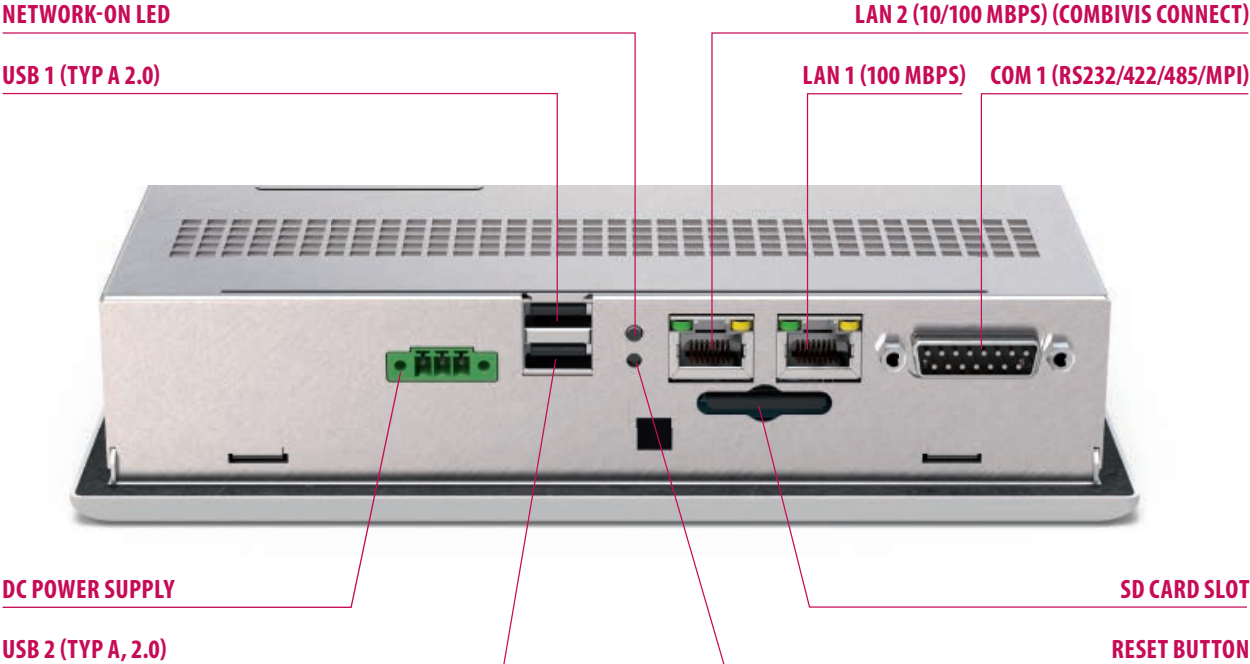

INTERFACES

Ethernet / EtherCAT®	1 x 100 Mbps (RJ45), 1 x 10/100 Mbps (RJ45)
USB on back	2 x USB 2.0
Serial interface	1 x RS232/422/485 (DB15M) / MPI 187.5 kbit/s
SD/SDHC card slot	External access / removable V 2.0 (push-push type)

PANEL SIZE	A	B	C	D	E	F	G	H	J	K	L	M	N
5.7"	175	145	5	40	–	7	–	131	–	–	161	164	134
7.0" W	215	155	5	40	–	7	–	141	–	–	201	204	144
8.4"	255	190	5	19.5	29	7.5	15	130	30	42	156	243	179
10.1"W	293	201.5	5	19.5	29	6.5	15	130	43.5	62	156	285	193.5
10.4"	295	230	5	19.5	29	7.5	15	130	70	62	156	283	219
12.1"	325	260	5	19.5	29	7.5	15	130	100	77	156	313	249
12.1"W	321	222.5	5	19.5	29	6.3	15	130	65	76	156	313	215
15.0"	390	305	6	19.5	29	7.5	15	130	145	109.5	156	378	294
15.6"W	420	265	6	19.5	29	7.5	15	130	105	124.5	156	410	255

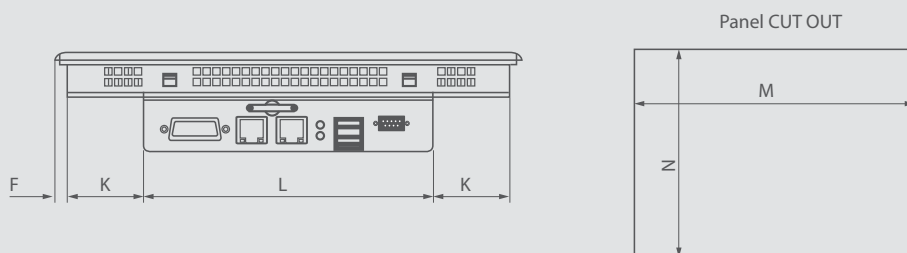
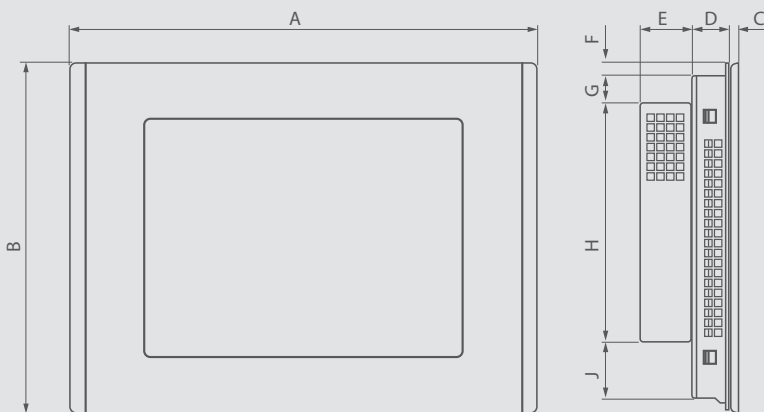

C6 S14



HIGHLIGHTS

- All in One – Automation solution
- Synchronous realtime control with EtherCAT Master
- High quality visualization
- Integrated remote maintenance
- Micro UPS for secure of non volatile memory
- Optimised processor power for synchronous motion control, rapid switching and detection of signals
- Smart system with integrated real-time controller, visualization and remote monitoring supplemented by a wide range of interfaces (USB, Ethernet, EtherCAT®, CANopen, RS232/485)

C6 S14

PROTECTION CLASS IP66

4:3 AND 16:9 FORMATS



ALUMINIUM FRAME

TOUCH SCREEN

16 MILLION COLOURS

PROTECTION CLASS IP66

4:3 AND 16:9 FORMATS

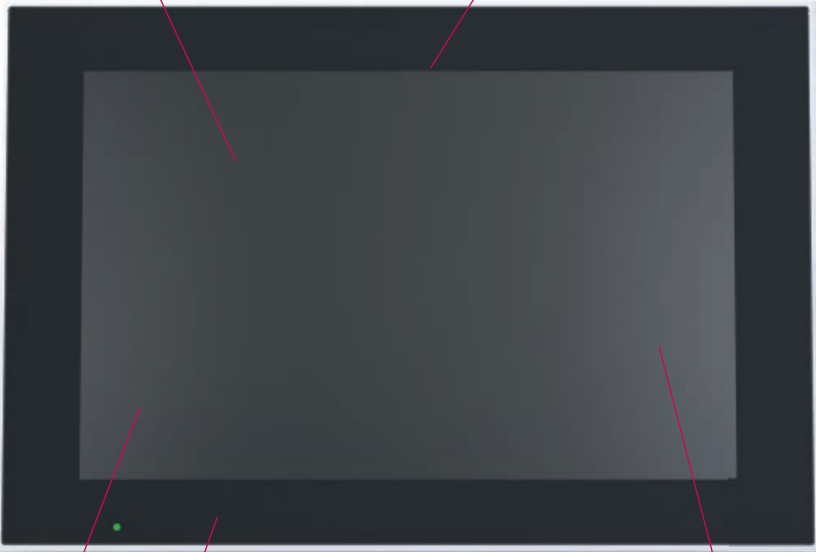

TOUCH SCREEN

ALUMINIUM GLAS

16 MILLION COLOURS

CPU

Processor	ARM Cortex A9 i.MX6 Duallite @ 1 GHz
System memory	1 GB DDR3-800
Graphic controller	Integrated ARM iMX6 Coretex A9

MASS MEMORY

eMMC (Solid State Disk)	4 GB for operating system and runtime environments (internal, not removable)
Application memory	8 GB project memory for further free use
Retain memory	128 KB persistent and retain

OPERATING DATA

Power supply	18 . . . 36 V DC incl. micro UPS (First charge in 30s, recharge in 15s)
Operating environment	0 . . . 50 °C, Rel. humidity 80 % (without condensation)
Storage conditions	-20 . . . 60 °C, Rel. humidity 80 % (without condensation)

OPERATING SYSTEM

Windows Embedded Compact 7 Pro

APPROVALS

CE (EN 55022, EN 61000-3-2/3, EN 55024, EN 60950-1), cULus LISTED (61010)

PANEL resistive

Display size	7"W	8.4"	10.1"W	10.4"	12.1"	12.1"W	15"	15.6"W
Format	15:9	4:3	16:10	4:3	4:3	16:10	4:3	16:9
Resolution	800 x 480	800 x 600	1280 x 800	800 x 600	800 x 600	1280 x 800	1024 x 768	1366 x 768
Colours	16 M	16 M	16 M	16 M	16 M	16 M	16 M	16 M
Brightness	500 cd/m ²	350 cd/m ²	400 cd/m ²	400 cd/m ²	450 cd/m ²	400 cd/m ²	450 cd/m ²	400 cd/m ²
Viewing angle (L:R/O:U)	140°, 130°	150°, 130°	170°, 170°	160°, 140°	160°, 140°	176°, 176°	160°, 140°	170°, 160°
Touch technology	Resistive 4 wire Resistive 5 wire							
Protection class	IP66 on front							
Front panel	Aluminium, Polycarbonate							

PANEL capacitive

Display size	7"W	10.1"W	12.1"W	15.6"W
Format	15:9	16:10	16:10	16:9
Resolution	800 x 480	1280 x 800	1280 x 800	1366 x 768
Colours	16 M	16 M	16 M	16 M
Brightness	500 cd/m ²	400 cd/m ²	400 cd/m ²	400 cd/m ²
Viewing angle (L:R/O:U)	140°, 130°	170°, 170°	176°, 176°	170°, 160°
Touch technology	capacitive			
Protection class	IP66 on front			
Front panel	Aluminium, glas			

C6 S14

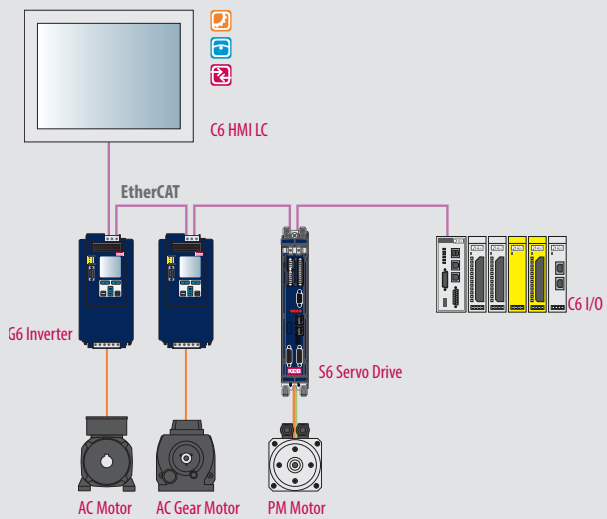
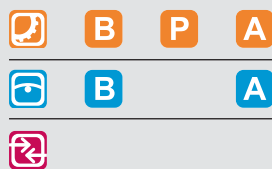
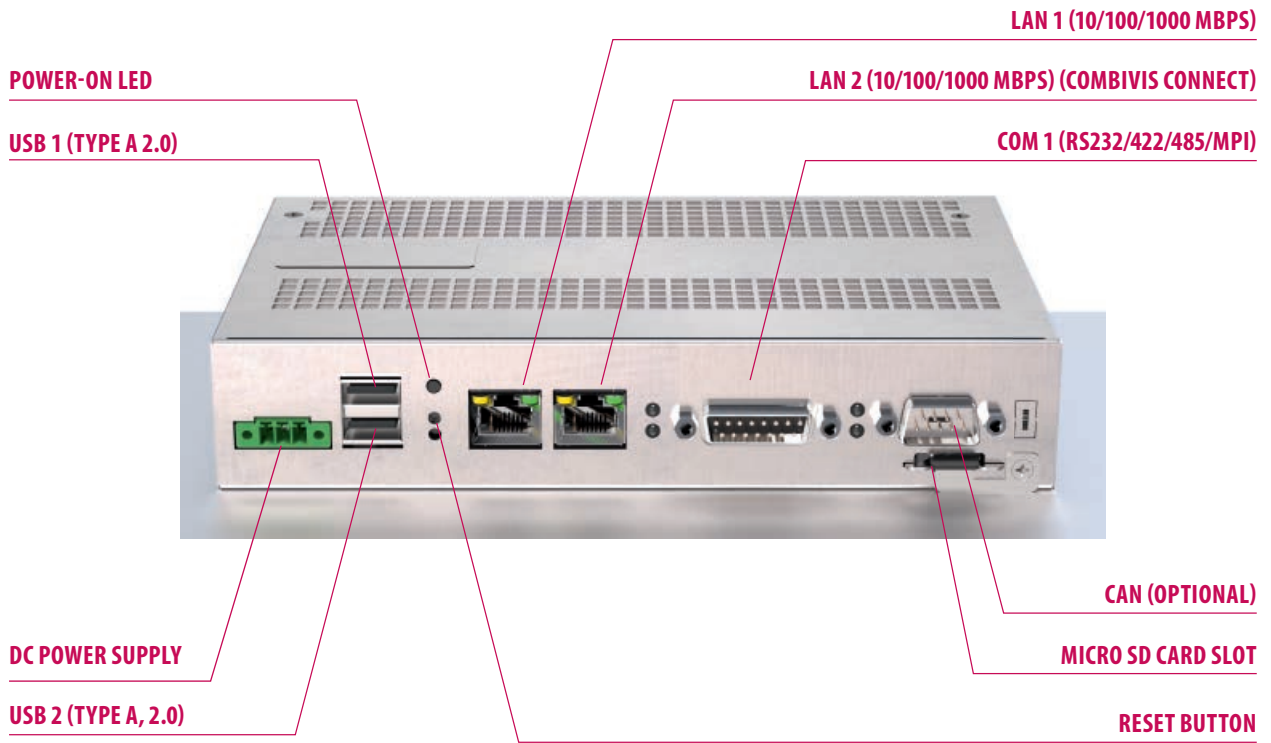

INTERFACES

Ethernet / EtherCAT®	2x 10/100/1000 Mbps (RJ45)
USB on back	2 x USB 2.0
Serial interface	1 x RS232/422/485 (DB15M) / MPI 187.5 kbit/s
CAN (optional)	CAN Master / slave with termination resistor (DB9M)
SD/SDHC card slot	External access / removable V 2.0 (push-push type)

PUSHBUTTON

Taster	Hardware reset
	Default settings

PANEL resistive

	A	B	C	D	E	F	G	H	J	K	L	M	N
7.0" W	215	155	5	48.6	–	7	–	141	–	–	201	204	144
8.4"	255	190	5	19.6	37	7.5	15	130	30	21.7	196.5	243	179
10.1"W	293	201.5	5	19.6	37	6.5	14.9	130	43.6	41.7	196.5	285	193.5
10.4"	295	230	5	19.6	37	7.5	14.9	130	70.1	41.7	196.5	283	219
12.1"	325	260	5	19.6	37	7.5	14.9	130	100	56.8	196.5	313	249
12.1"W	321	222.5	5	19.6	37	6.5	14.9	130	65	55.8	196.5	313	215
15.0"	390	305	6	19.6	37	7.5	14.9	130	72.6	89.3	196.5	378	294
15.6"W	420	265	6	19.6	37	7.5	14.9	130	105	104.2	196.5	410	255

PANEL capacitive

	A	B	C	D	E	F	G	H	J	K	L	M	N
7.0" W	204	147.6	4	48	–	5	–	137.5	–	–	194	197	140.5
10.1"W	293	201.5	5	18.8	37	6.5	14.9	130	43.6	41.8	196.5	285	193.5
12.1"W	321	222.5	5	21.5	37	6.5	14.9	130	65	55.7	196.5	313	215
15.6"W	420	267	6	19.5	37	8	14.9	130	105.1	104.3	196.5	410	255

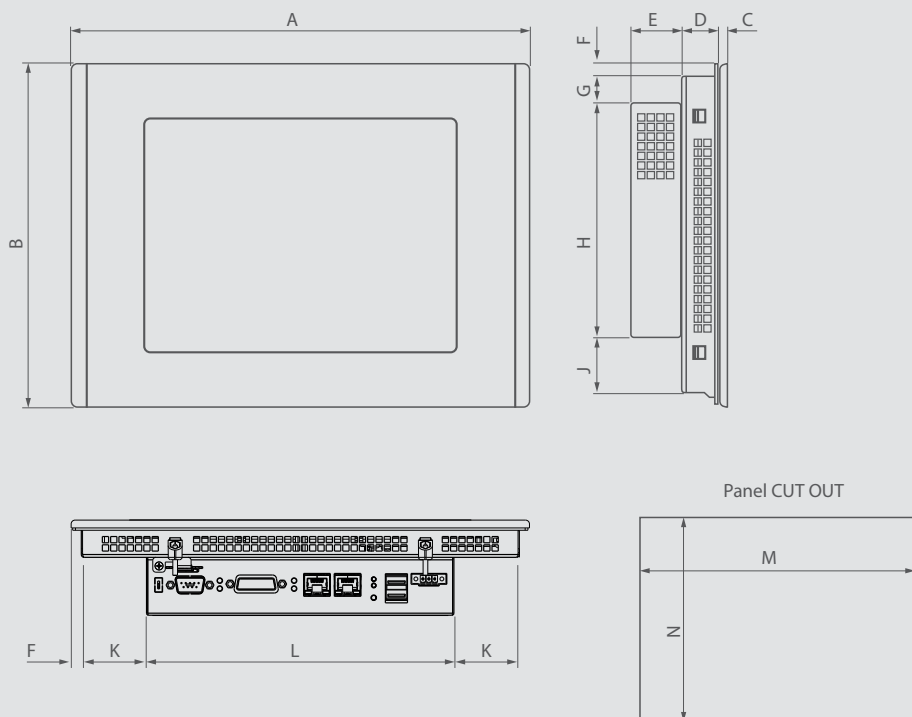

C6 SMART

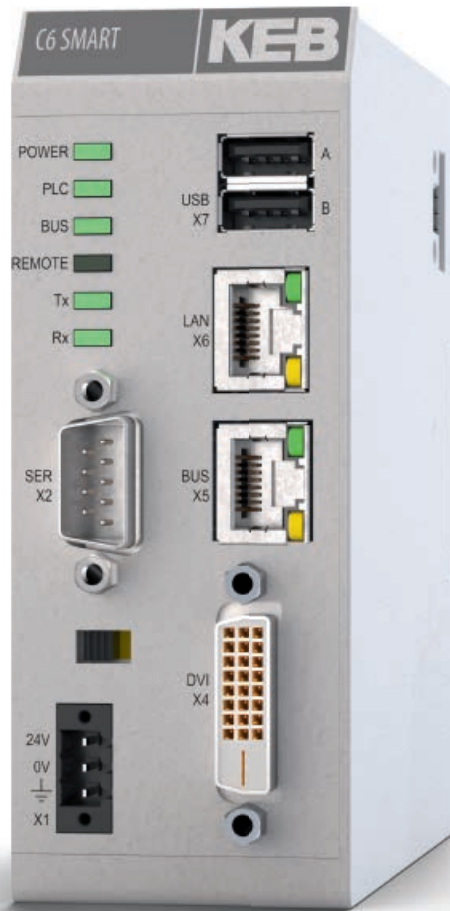

HIGHLIGHTS

- Super compact = 47 x 122 x 124
- DIN rail IPC with flexible expandable I/O assemblies and integrated micro UPS
- Optimised processor power for synchronous motion control, rapid switching and detection of signals
- Smart system with integrated real-time controller, visualization and remote monitoring supplemented by a wide range of interfaces (DVI, USB, Ethernet, EtherCAT®, CANopen, RS232/485)

C6 SMART

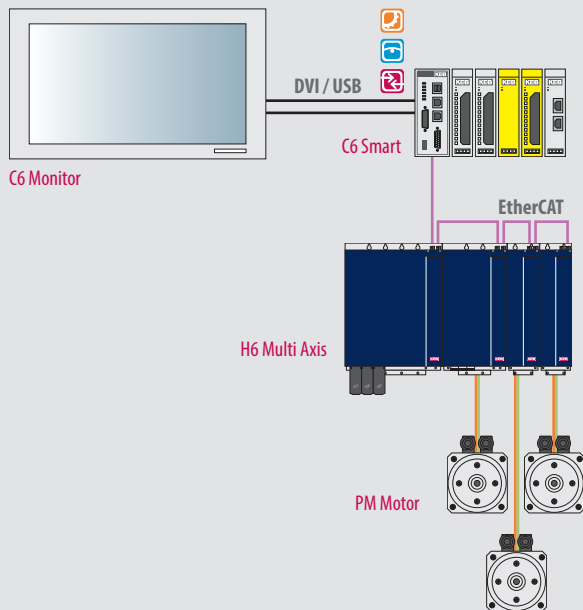
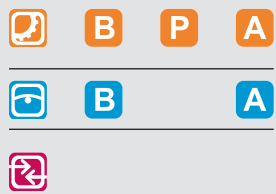

CPU

Processor	ARM iMX6 Dual Core Cortex-A9 @ 1 GHz
System memory	RAM 1 GB
Graphic controller	Integrated in ARM iMX6 Cortex A9

MASS MEMORY

System memory	4 GB for operating system and runtime environments
Application memory	8 GB project memory for free use
Retain memory	128 KB persistent and retain

OPERATING DATA

Power supply	18 . . . 36 V DC incl. Micro UPS
Operating environment	0 . . . 50 °C, Rel. humidity up to 95 % (without condensation)
Storage conditions	-20 . . . 60 °C, Rel. humidity up to 95 % (without condensation)

OPERATING SYSTEM

	Windows Embedded Compact 7 Pro
--	--------------------------------

APPROVALS

	CE, cULus
--	-----------

C6 SMART

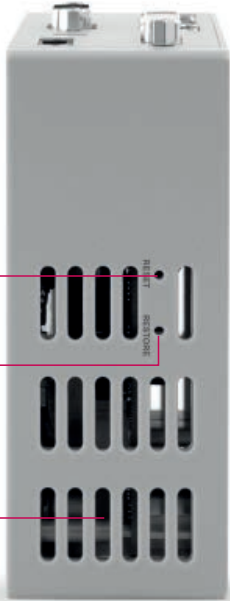

RESET BUTTON

**RESTORE BUTTON, ZUM ZURÜCKSETZEN
DES STEUERUNGSSYSTEMS**

INTEGRIERTE MICRO USV

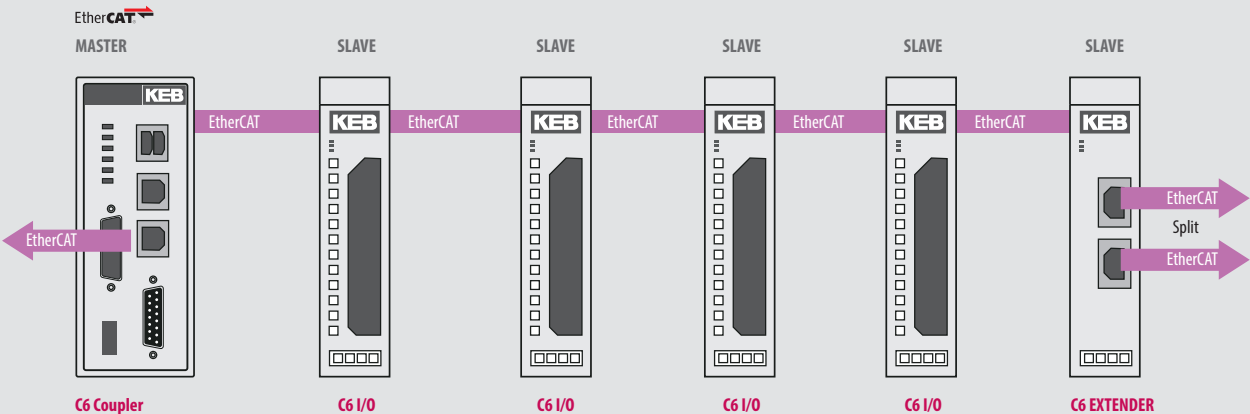

INTERFACES

Ethernet	1 x 10/100/1000 Mbps (RJ45)
EtherCAT®	1 x EtherCAT® Master(RJ45) 1 x E-BUS Port / supply: 5 V/3A (approx. 20 IO-modules)
USB	2 x USB 2.0
Monitor output	1 x DVI
Diagnostics	Multicolour LED

OPTIONS

Serial interfaces	1 x RS232/485 opto-isolated
CAN	CAN Master / Slave with terminating resistor

PUSHBUTTON

Taster	Hardware reset Default settings
--------	------------------------------------

A	B	C	D	E
47	122	124	42,8	17,5

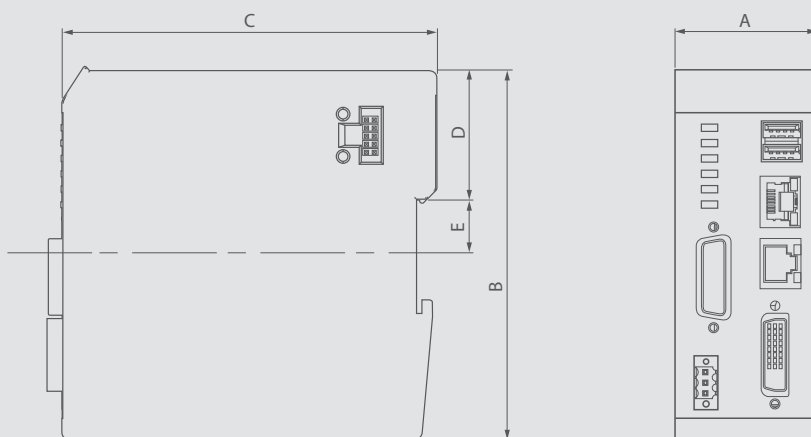

C6 COMPACT



HIGHLIGHTS

- True real-time performance thanks to powerful 32-bit microcontroller with integrated Floating Point Unit
- No operating system to reduce resources
- Programming and code processing to IEC 61131-3
- Rapid real-time bus system with integrated EtherCAT®-Master
- Various slave interfaces as optional equipment

C6 COMPACT

SERIAL (RS232 / 485)

FIELDBUS (OPTIONAL)

STATUS-LED

MULTIFUNCTION SWITCH

ETHERNET

TOP HAT RAIL MOUNTING

DC POWER SUPPLY
4X DI / 4X DO



B **P**

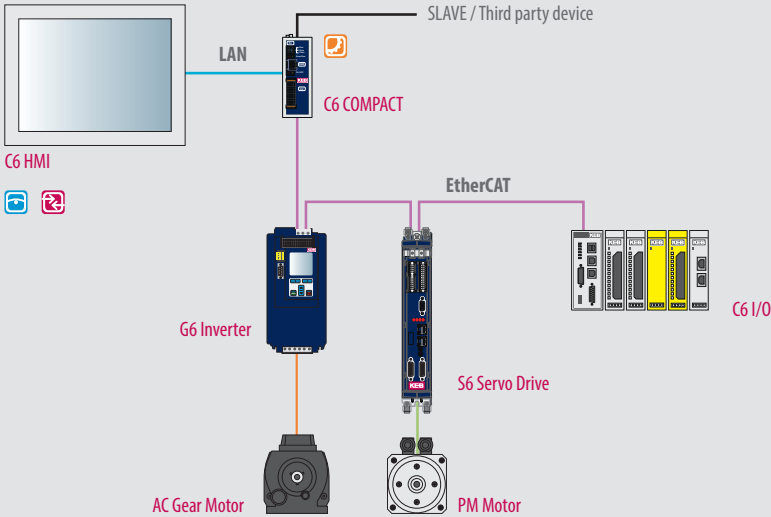

CPU

Processor	SH7269 - 32-Bit RISC Microcomputer SuperHTM RISC engine inc. Floating Point Unit
Mass memory	
System memory	256 MB Flash, Boot Application + files, 32 MB RAM, Code + Data
Retain memory	32 KB

OPERATING DATA

Power supply	18 ... 30 V DC
Operating environment	-10 ... 45 °C, Rel. humidity 5 ... 80 % (without condensation)
Storage conditions	-25 ... 70 °C, Rel. humidity 5 ... 80 % (without condensation)

APPROVALS

CE

C6 COMPACT

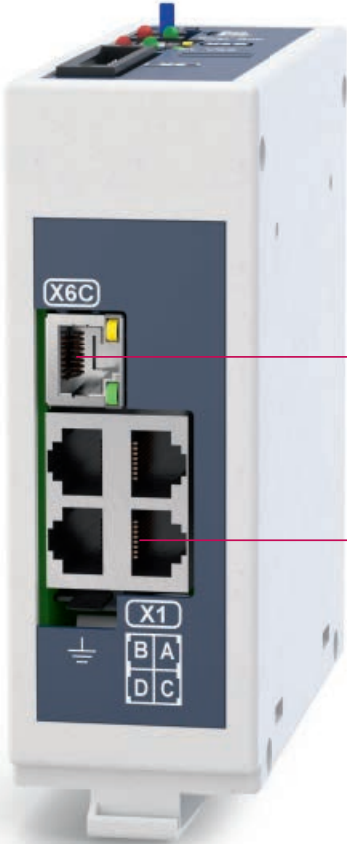

ETHERCAT

DIRECT AXIS INTERFACES HSP 5



OPTIONAL FIELBUS INTERFACE

SERIAL INTERFACE RS232/485

INTERFACES

Ethernet	1 x 10/100 Mbps (RJ45)
EtherCAT®	1 x EtherCAT® Master(RJ45)
HSP5	4 x KEB HSP5 (RJ45)
Serial	1 x RS232/485
Diagnostic	LED

OPTIONS

Fieldbus systems	Profibus Slave interface
	Profinet Slave interface
	EtherCAT® Slave interface
	CAN Master/Slave interface
	Interbus Slave interface
	Powerlink Slave interface

DIGITAL I/O'S

4 x Digital input (1 x fast input: 100 µs)
4 x Digital output (24 V; max. 0.7 A per channel), short-circuit resistant

TYPE	A	B	C	D	E	F
C6 Compact	45	130	35	41,3	126,5	118

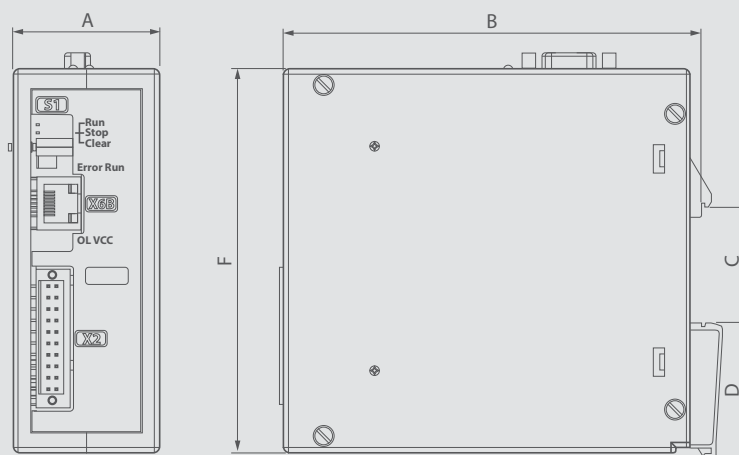

H6 CONTROL UNIT

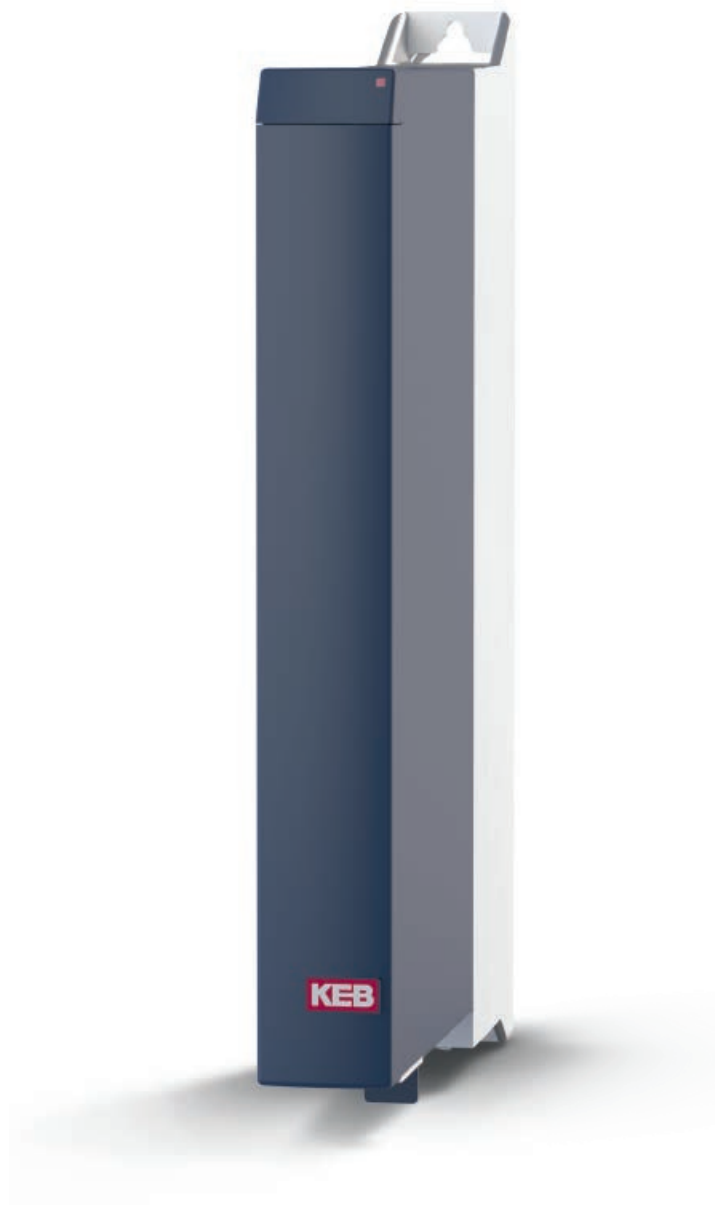

HIGHLIGHTS

- True real-time performance thanks to powerful 32-bit microcontroller with integrated Floating Point Unit
- No operating system to reduce resources
- Programming and code processing to IEC 61131-3
- Rapid real-time bus system with integrated EtherCAT®-Master
- Various slave interfaces as optional equipment

H6 CONTROL UNIT

DC POWER SUPPLY

DC BUS

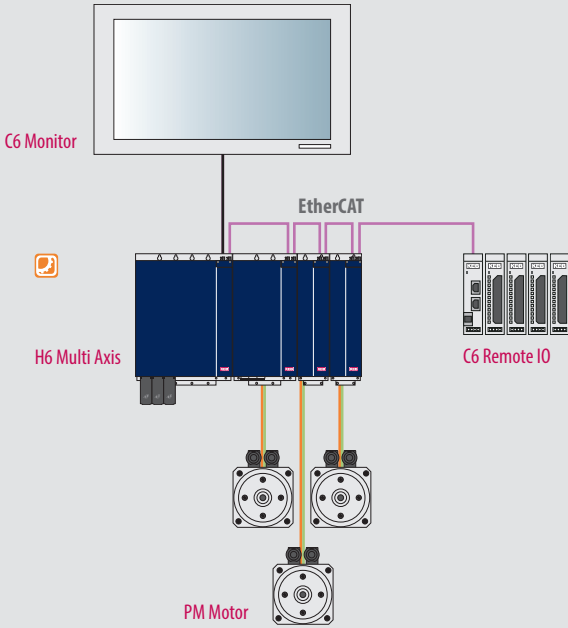
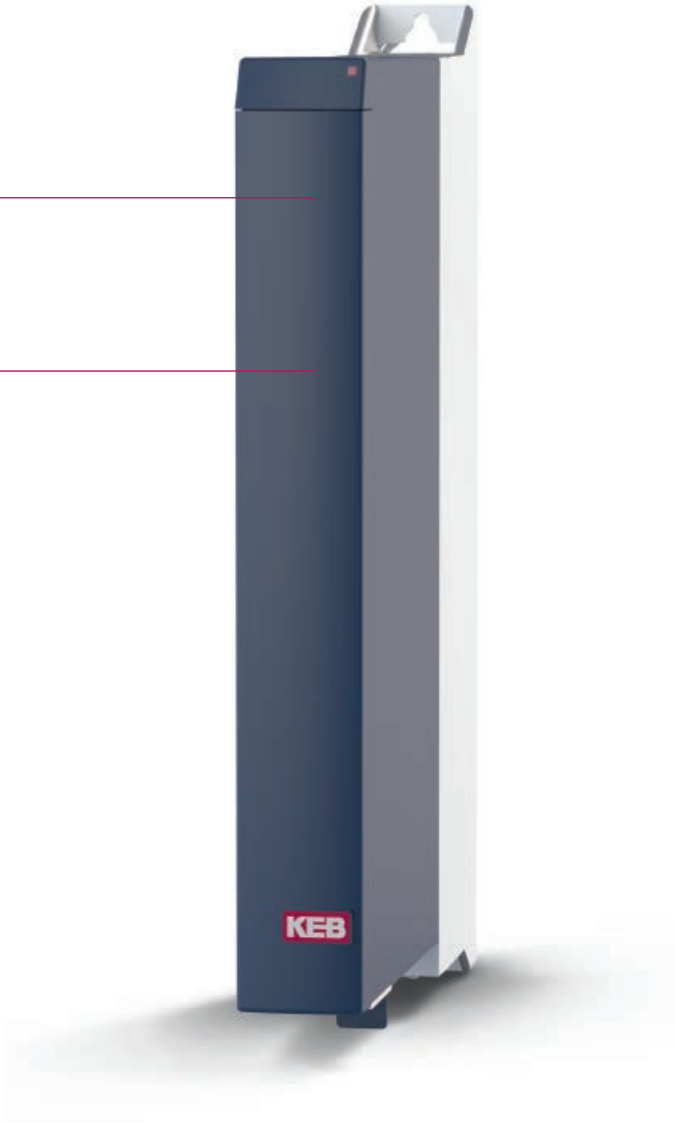

CPU

Processor	SH7269 - 32-Bit RISC Microcomputer SuperHTM RISC engine inc. Floating Point Unit
Mass memory	
System memory	256 MB Flash, Boot Application + files, 32 MB RAM, Code + Data
Retain memory	32 KB

OPERATING DATA

Power supply	18 ... 30 V DC
Operating environment	-10 ... 45 °C, Rel. humidity 5 ... 85 % (without condensation)
Storage conditions	-25 ... 55 °C, Rel. humidity 5 ... 95 % (without condensation)

APPROVALS

CE, UL

H6 CONTROL UNIT

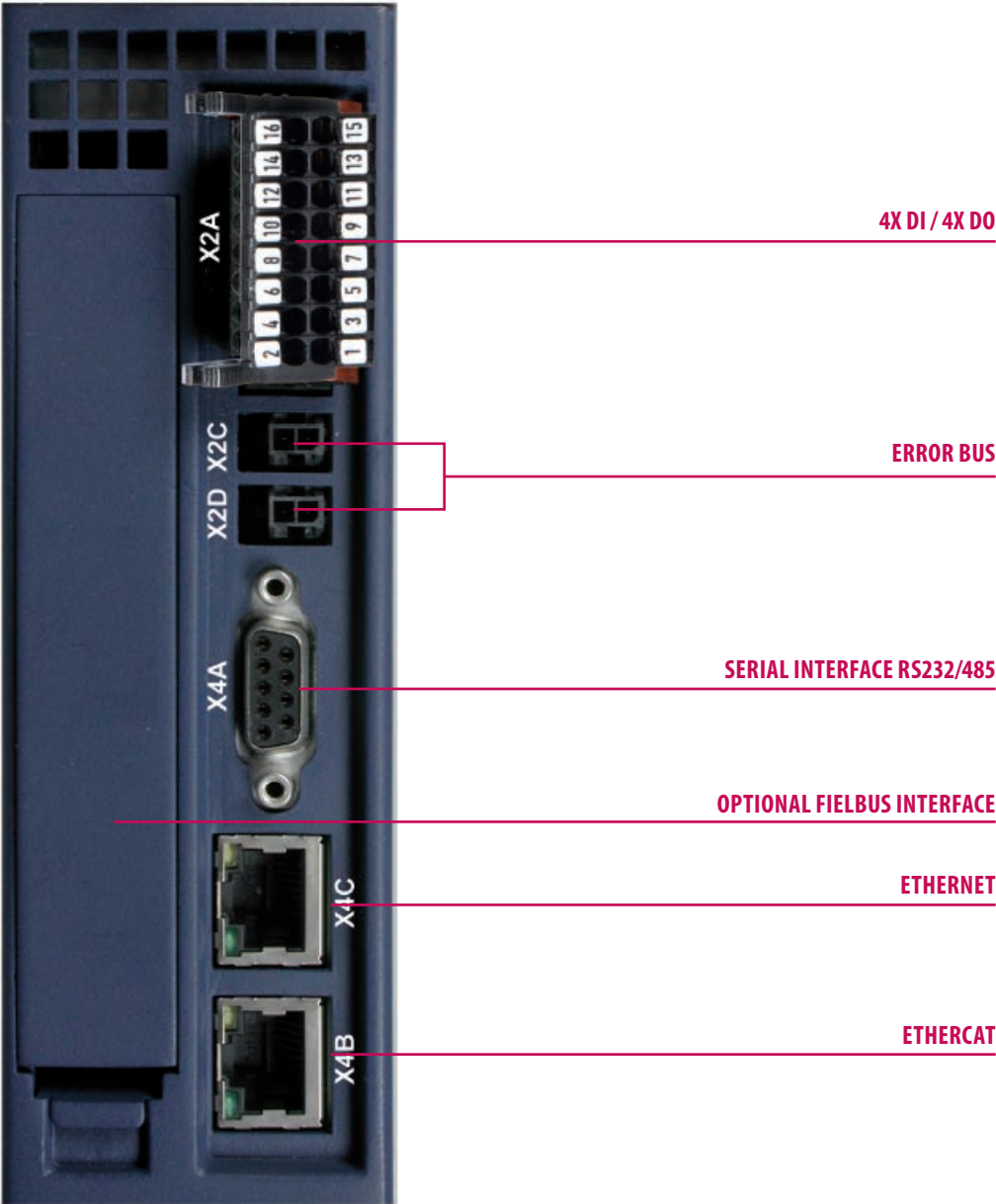

INTERFACES

Ethernet	1 x 10/100 Mbps (RJ45)
EtherCAT®	1 x EtherCAT® Master(RJ45)
Serial	1 x RS232/485
Diagnostic	LED

OPTIONS

Fieldbus systems	Profibus Slave interface
	Profinet Slave interface
	EtherCAT® Slave interface
	CAN Master/Slave interface
	Interbus Slave interface
	Powerlink Slave interface

DIGITAL I/O'S

4 x Digital input (1 x fast input: 100 µs)
4 x Digital output (24 V; max. 0.7 A per channel), short-circuit resistant

TYPE

	A	B	C	D	E
H6 Control unit	50	198	7	395	407

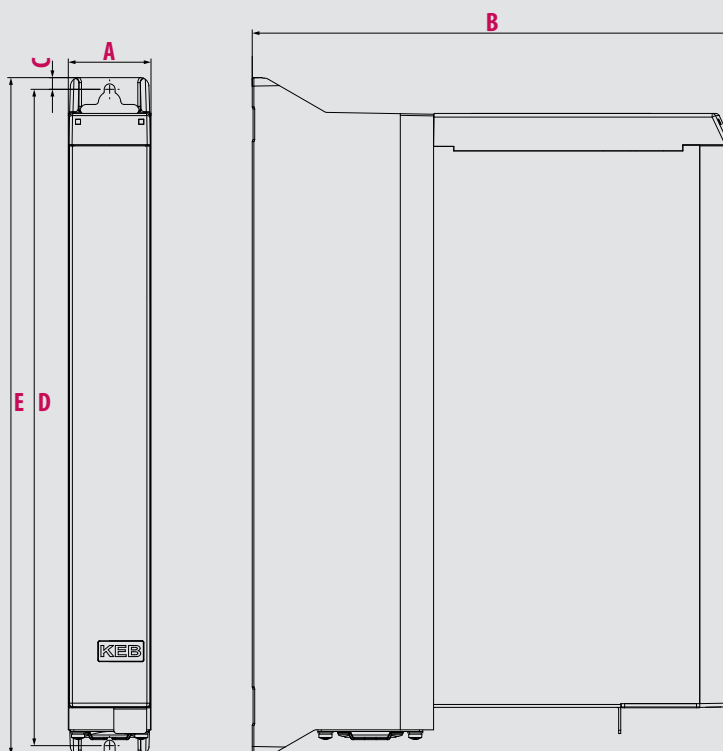

C6 SAFETY



HIGHLIGHTS

- Freely programmable Safety PLC (IEC 61508 SIL3 and DIN EN ISO 13849-1 Plc)
- Certified safety function modules
- Substantial reduction in time spent in development, verification and testing of a safety application
- Programming by means of CODESYS Safety by main controller and EtherCAT® connection

C6 SAFETY PLC

ETHERCAT FIELDBUS FAIL SAFE OVER ETHERCAT (FSOE)

REDUNDANT SAFETY CONTROLLER

SAFETY CONTROLLER INTEGRATED IN CONTROL CONCEPT

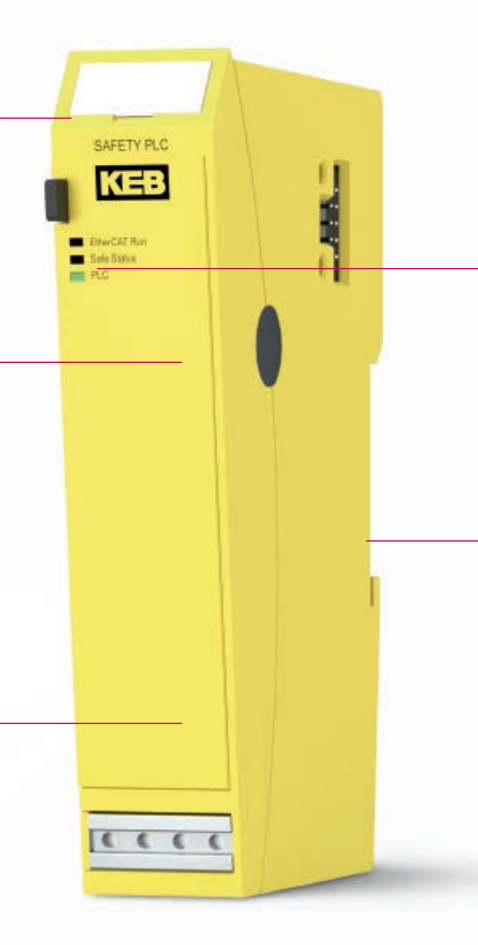

SIGNAL DISPLAY

TOP HAT RAIL FIXING AND FUNCTION EARTH

Safety over
EtherCAT
EtherCAT

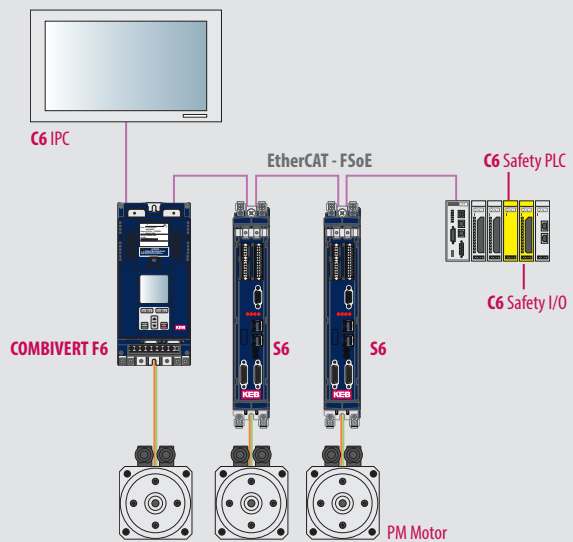

C6 SAFETY CONTROLLER

Safety protocol	FSoE
Safety standard	IEC 61508 SIL3 and DIN EN ISO 13849-1 PLe
Approvals	CE, cULus, TÜV Rheinland
Runtime system	CODESYS RT Safety
Programming tool	CODESYS Safety integrated from COMBIVIS studio 6 V3.6.60
E-Bus power consumption	240 mA
Power supply	Via E-Bus connection
Resistance to interference	EN 61000-6-2/ EN 61000-6-4
Resistance to vibration/shock	EN 60068-2-6 / EN60068-2-27
Signal display	Status LEDs (EtherCAT®, Safety, Power)
Ambient conditions	0 °C ... +55 °C, IP20
Housing	Aluminium carrier, exterior plastic 25 x 120 x 90 mm

C6 SAFETY I/O

**ETHERCAT FELDBUS
SAFETY OVER ETHERCAT (FSoE)**

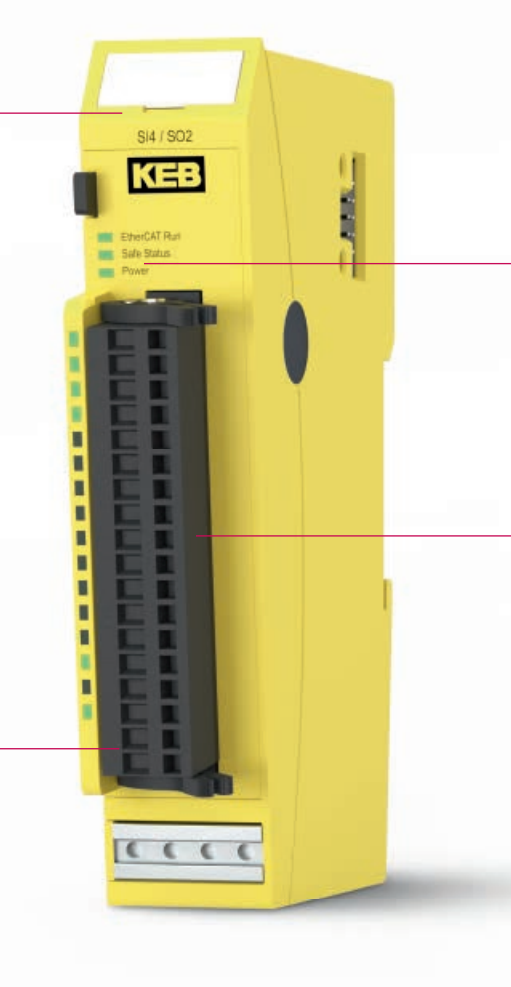

SIGNAL DISPLAY

**SECURE CONNECTION
INPUTS/OUTPUTS**

**EXTRA ADDRESSING
FSOE SLAVE FOR
SAFETY REASONS**

Safety over
EtherCAT®
EtherCAT®

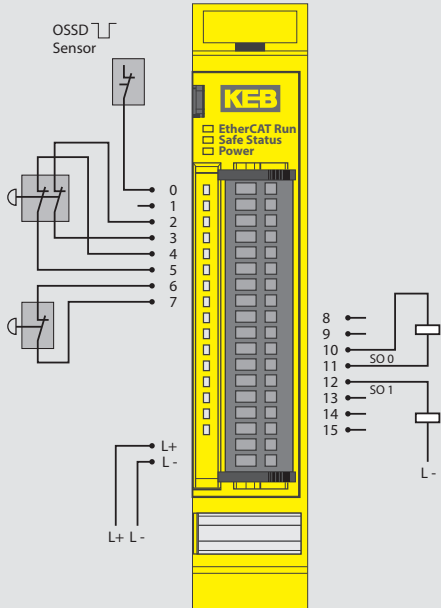

C6 SAFETY INPUT / OUTPUT TERMINALS

Safety protocol	FSoE
Safety standard	IEC 61508 SIL3 and DIN EN ISO 13849-1 Ple
Number of inputs	4 safe inputs
Number of outputs	2 safe outputs (IMAX = 2 A)
Cycled outputs (OSSD)	4
Reaction time	< 1 ms (read input, write to E-Bus)
Fault reaction time	≤ Watchdog time (adjustable)
Extended diagnostics	Via COE
Signal display	LEDs per I/O: spatially assigned to the terminal point Status LEDs (EtherCAT®, Safety, Power)
E-Bus power consumption	300 mA
Power supply	24 V DC (-15% / +20%)
Resistance to interference	EN 61000-6-2/ EN 61000-6-4
Resistance to vibration/shock	EN 60068-2-6 / EN60068-2-27
Approvals	CE, cULus, TÜV Rheinland
Ambient conditions	0 °C ... +55 °C, IP20
Housing	Aluminium carrier, external plastic 25 x 120 x 90 mm

C6 ROUTER



HIGHLIGHTS

- Remote monitoring using Ethernet-based router
- Worldwide support from several server locations
- Also available as router with integrated 2G/3G/3G+ modem
- Access to remote devices via Ethernet or serial interface
- Proven COMBIVIS connect software connects the plant to be monitored to your workplace via VPN
- Additional HMI functionality for datalogging, long-term machine diagnostics and notification by E-Mail and SMS

C6 ROUTER

DC POWER SUPPLY
2X DI / 5" DO

2G/3G/3G+/4G
ANTENNA

STATUS-LED

ETHERNET LAN

ETHERNET WAN

SERIAL
(RS 232 / 422 / MPI)

SIM CARD
SLOT (REAR)



COMBIVIS connect
COMBIVIS studio 6
COMBIVIS HMI



Internet

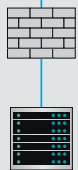

COMBIVIS connect
Server infrastructure

COMBIVIS connect
Runtime

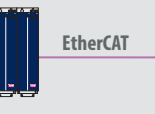
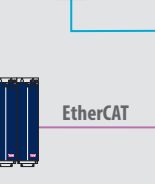
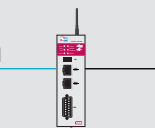

C6 ROUTER E / M (3G/3G+)

	C6 ROUTER E1	C6 ROUTER E2	C6 ROUTER E3	C6 ROUTER E4	C6 ROUTER M1	C6 ROUTER M2
Remote maintenance	CONNECT	CONNECT	-	CONNECT	CONNECT	CONNECT
Visualisierung	-	HMI	HMI	HMI	-	HMI
Cloud	-	-	Cloud	Cloud	-	-
MOBILE NETWORK					3G / 3G+	
Type	-	-	-	-	2G/3G/3G + EDGE/HSPA Quadband Modem up to 5,76 Mbps upload / 21,6 Mbps download	
Band	-	-	-	-	UUMTS/HSPA+: B1/B2/B5; GSM/GPRS/EDGE: 850/900/1800/1900 MHz	
Region	-	-	-	-	Europe, North- / Latin America, Asia, Africa, Oceania	
Antenna	-	-	-	-	1 x SMA plug (various additional antenna options)	
SIM	-	-	-	-	1 x SIM Card (mini) socket push-push type	

CPU

Processor	ARM Cortex A8 processor Freescale® i.MX535 1 GHz
-----------	--

MEMORY

System memory	RAM - 1 GB	
NAND-Flash	256 MB for operating system and runtime environments (internal, not removable)	
eMMC (Solid State Disc)	2 GB project memory for free use	4 GB project memory for free use

OPERATING DATA

Power supply	9 ... 36 V DC
Operating environment	0 ... 50 °C (-20 ... 70 °C Option), rel. humidity up to 95 % (without condensation)
Lagerbedingungen	-20 ... 60 °C (-20 ... 70 °C Option), rel. humidity up to 95 % (without condensation)

OPERATING DATA

	Windows Embedded Compact 7 Pro
--	--------------------------------

APPROVALS

	CE, cULus
--	-----------

INTERFACES

Ethernet	WAN 1 x 10/100 Mbps (RJ45)
	LAN 1 x 100 Mbps (RJ45)
USB on back	1 x USB 2.0
Serial interface	1 x RS232/422/485 (DB15M) / MPI 187. kbit/s (galvanically separated)

DIGITAL I/O'S

Inputs	IN0 - Secured activation WAN connection. Function controlled by COMBIVIS Control Center
	IN1 - C6 Router software reset
Ausgänge	OUT0 C6 Router WAN connection active (output relay max. 200 mA /24 V DC)
	OUT1 remote monitoring active (output relay max. 200 mA /24 V DC)

PUSHBUTTON

Buttons	C6 Router hardware reset
	C6 Router default setting

C6 ROUTER

C6 ROUTER L (4G/LTE)

	C6 ROUTER L1	C6 ROUTER L2	C6 ROUTER L3	C6 ROUTER L4
Remote maintenance	CONNECT	CONNECT	-	CONNECT
Visualization	-	HMI	HMI	HMI
Cloud	-	-	Cloud	Cloud
MOBILE NETWORK	4G/LTE			
Type	2G/3G/4G LTE Pentaband Modem up to 50 Mbps upload/100 Mbps download			
Band	FDD-LTE: B1/B3/B7/B8/B20; TDD-LTE: B38/B40; UMTS/HSPA+: B1/B8; GSM/GPRS/EDGE: 900/1800 MHz			
Region	Europe, Latin America, Asia, Africa, Oceania			
Antenna	1 x SMAStecker (various additional antenna option)			
SIM	1 x SIM Card (mini) socket push-push type			
CPU				
Processor	ARM Cortex A8 processor Freescale® i.MX535 1 GHz			
MEMORY				
System memory	RAM - 1 GB			
NAND Flash	256 MB für Betriebssystem und Laufzeitumgebungen (intern, nicht entfernbar)			
eMMC (Solid State Disk)	4 GB Projektspeicher zur freien Nutzung			
BETRIEBSDATEN				
Power supply	9 ... 36 V DC			
Operating environment	0 ... 50 °C (-20 ... 70 °C Option), rel. humidity up to 80 % (without condensation)			
Storage conditions	-20 ... 60 °C (-20 ... 70 °C Option), rel. humidity up to 80 % (without condensation)			
OPERATING SYSTEM				
	Windows Embedded Compact 7 Pro			
APPROVALS				
	CE, cULus			
INTERFACES				
Ethernet	WAN 1 x 10/100 Mbps (RJ45)			
	LAN 1 x 100 Mbps (RJ45)			
USB on back	1 x USB 2.0			
Serial interface	1 x RS232/422/485 (DB15M) / MPI 187,5 kbit/s (galvanically separated)			
DIGITAL I/O'S				
Inputs	IN0 - Secured activation WAN connection. Function controlled by COMBIVIS Control Center			
	IN1 - C6 Router software reset			
Outputs	OUT0 C6 Router WAN connection active (output relay max. 200 mA /24 V DC)			
	OUT1 remote monitoring active (output relay max. 200 mA /24 V DC)			
PUSHBUTTON				
Buttons	C6 Router Hardware Reset			
	C6 Router default setting			

ROUTER L (4G) / K (4G-AM)

	C6 ROUTER K1	C6 ROUTER K2	C6 ROUTER K3	C6 ROUTER K4
Remote maintenance	CONNECT	CONNECT	-	CONNECT
Visualization	-	HMI	HMI	HMI
Cloud	-	-	Cloud	Cloud
MOBILE NETWORK	4G-AM			
Type	2G/3G/4G Pentaband Modem up to 50 Mbps upload/100 Mbps download			
Band	FDD-LTE: B2/B4/B5/B17; UMTS/HSPA+: B2/B5			
Region	North- / Latin America			
Antenna	1 x SMAStecker (various additional antenna options)			
SIM	1 x SIM Card (mini) socket push-push type			
CPU				
Processor	ARM Cortex A8 processor Freescale® i.MX535 1 GHz			
MEMORY				
System memory	RAM - 1 GB			
NAND-Flash	256 MB for operating system and runtime environments (internal, not removable)			
eMMC (Solid State Disk)	4 GB project memory for free use			
OPERATING DATA				
Power supply	9 ... 36 V DC			
Operating environment	0 ... 50 °C (-20 ... 70 °C Option), rel. humidity up to 80 % (without condensation)			
Lagerbedingungen	-20 ... 60 °C (-20 ... 70 °C Option), rel. humidity up to 80 % (without condensation)			
OPERATING SYSTEM				
	Windows Embedded Compact 7 Pro			
APPROVALS				
	CE, cULus			
INTERFACES				
Ethernet	WAN 1 x 10/100 Mbps (RJ45)			
	LAN 1 x 100 Mbps (RJ45)			
USB on back	1 x USB 2.0			
Serial interface	1 x RS232/422/485 (DB15M) / MPI 187,5 kbit/s (galvanically separated)			
DIGITAL I/O'S				
Inputs	INO - Secured activation WAN connection. Function controlled by COMBIVIS Control Center			
	IN1 - C6 Router software reset			
Outputs	OUT0 C6 Router WAN connection active (output relay max. 200 mA / 24 V DC)			
	OUT1 remote monitoring active (output relay max. 200 mA / 24 V DC)			
PUSHBUTTON				
Buttons	C6 Router hardware reset			
	C6 Router default setting			

C6 ROUTER

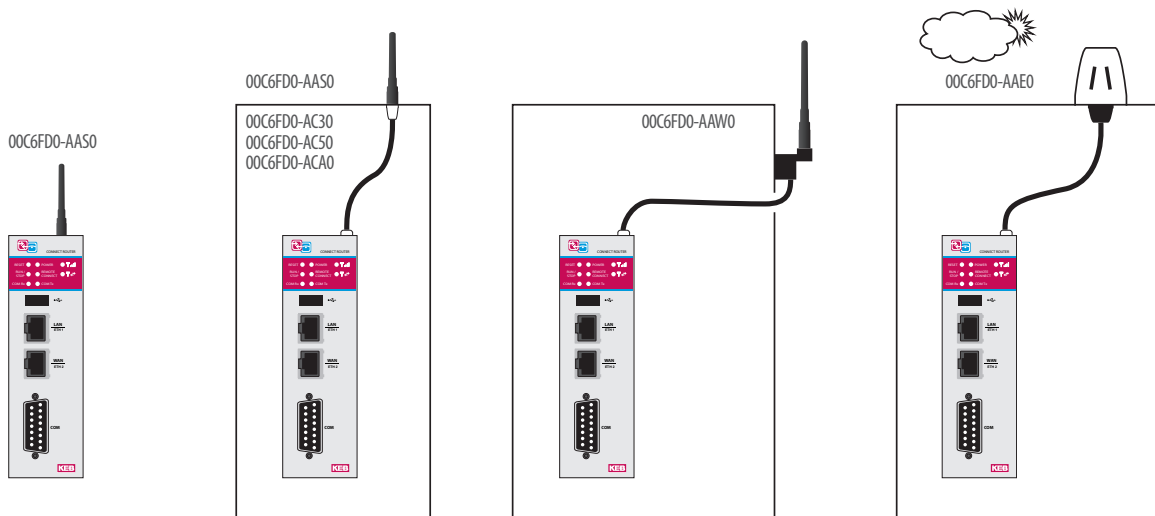

Stick antenna

Stick antenna extension 3, 5, 10 m

Stick antenna Wall mounted IP67, 3 m

Outdoor antenna IP67, 1 m

	A	B	C	D	E	F	G
C6 ROUTER EX	35	177	116	138	159	4	14
C6 ROUTER MX	45	177	116	138	159	4	14

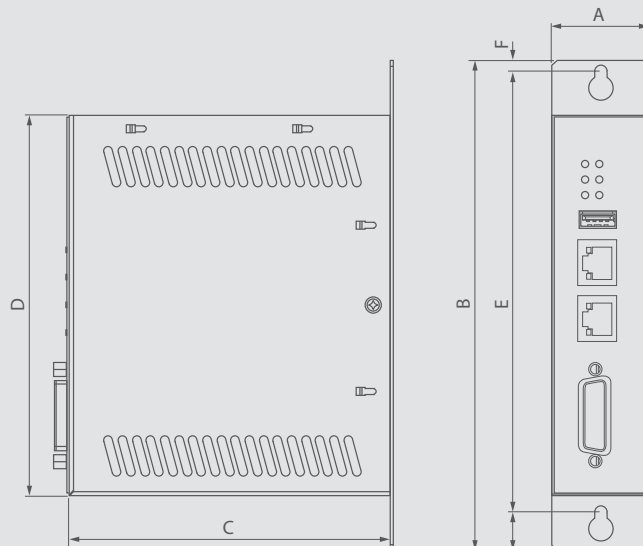



The C6 Router can be configured via two different communication paths:

- manually with local network connection
- from exported configuration data via USB memory stick



The configuration of the C6 Router is protected with necessary log-on data.

The routers available in the local network are identified via unique MAC addresses.

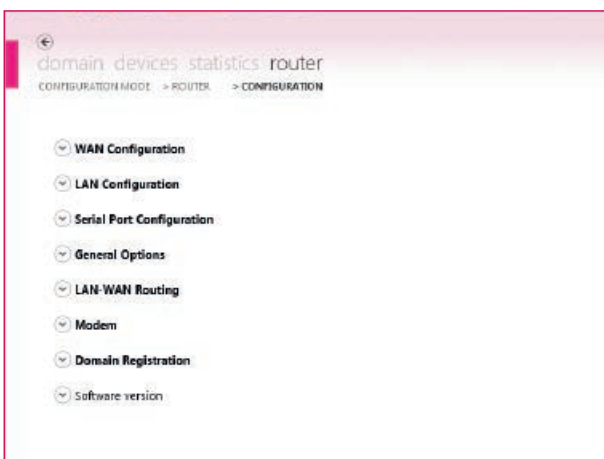

The configuration level is easy to understand, self-explanatory and limited to a minimum number of parameters.

However a number of communication paths are possible, guaranteeing a high usage density.

CONFIGURATION

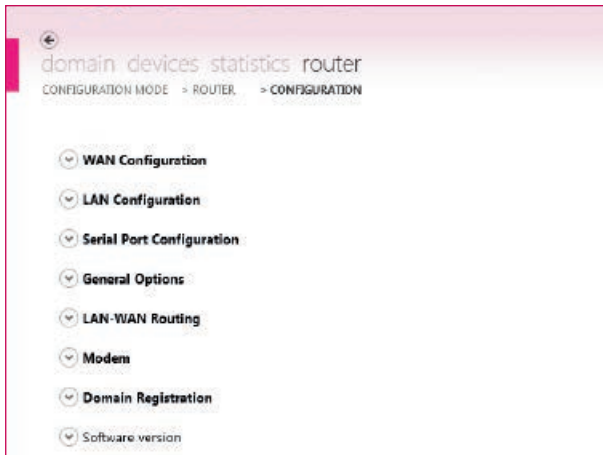

After a few minutes of router configuration, you have worldwide access to remote devices for maintenance and monitoring - irrespective of device type and manufacturer.

CONFIGURATION STEPS

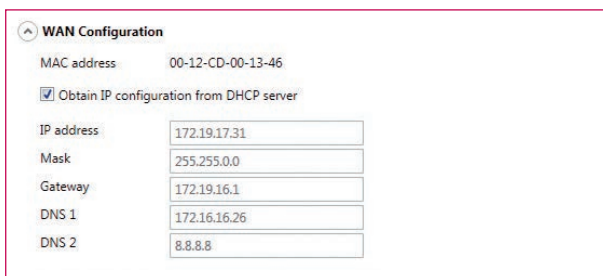

Step 1

WAN-Port as Internet access (server infrastructure) – IP address can be assigned statically or automatically via DHCP.

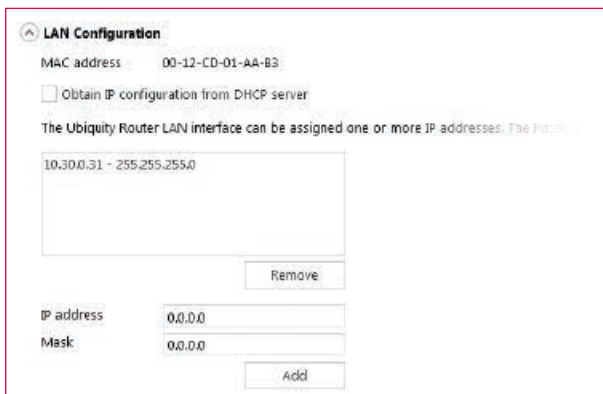

Step 2

IP configurations from one or more local automation networks accessible via VPN tunnel.

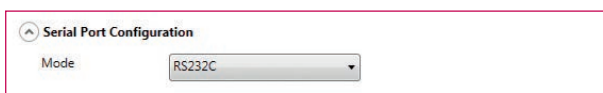

Step 3

As well as local Ethernet-linked networks, serial connections can be set up via a VPN tunnel.



General Options

New password:

Confirm password:

Availability mode:

Internet connectivity:

Proxy configuration:

Proxy address:

Proxy port:

Proxy username:

Proxy password:

Step 4

Variable configuration with regard to connection type (WAN, Modem), handling of Internet activation (constant, via SMS and/or digital input).

LAN-WAN Routing

Enabled

Add IP addresses (i.e. 192.168.100.1/255.255.255.255) or ranges (i.e. 192.168.100.0/255.255.255.0)

I/F	IP address	Subnet mask
WAN	172.17.129.0	255.255.255.0
LAN	192.168.0.0	255.255.255.0

IF:

IP address:

Mask:

Step 5

The LAN-WAN routing allows configuration of rules between the two Ethernet interfaces of the router (LAN and WAN) which define the static routing of individual IP addresses or address ranges.

Modem

Status:

Carrier mode:

Signal strength:

PIN code:

APN:

Username:

Password:

Domain:

Dialled number: i.e. *00#

Step 6

To be able to use Internet access via modem (UMTS), the provider access data (SIM card) can be configured here.

Domain Registration

The domain registration operation creates a new Router identity on the server and assigns an initial name. The device is initially located into the root of your domain. You can later rename the device or move it into another subfolder by using the Domain browser.

The registration operation will overwrite a previous identity if already present. Please double check that you want to do it.

Create and register a new identity for the Router into the domain.

Initial name: Please insert a valid name

Folder: Please select a folder

Step 7

Domain registration opens the possibilities of remote device maintenance, and access can be managed user oriented.



KEB





IPC TECHNOLOGY

An industrial PC (IPC for short) is a computer used for tasks in the industrial sector. Typical sectors are industrial automation and visualization. IPC technology differs from embedded technology primarily in the higher performance of processor platforms and higher quality of operating systems.

Further requirements for IPC are a long availability period of at least 10 years, reliable hardware which is designed for rough industrial environments, and processing of control tasks in real-time.

- **C6 E22 Panel / Box / Book mount**
- **C6 P33 Book mount**
- **C6 P34 Panel / Box / Book mount**

C6 E22



HIGHLIGHTS

- Fanless IPC up to 50 °C operating temperature
- Intel® Bay Trail Platform with 64 Bit architecture
 - Celeron® J1900 2 Ghz, 4 Cores, 4 Threads
- Wide range of 16 million colours LED backlight TFT LCD Displays with resistive or capacitive touch technology
 - 4:3 Format: 10.4", 12.1", 15", 17" (5:4), 19" (5:4); 16:9 Format: 10.1", 12.1" (16:10), 15.6", 18.5", 21.5", 24"
- Slim Version (SL) for installation situations with limited space
- Smart memory concept for maximum flexibility in application

C6 E22 PANEL

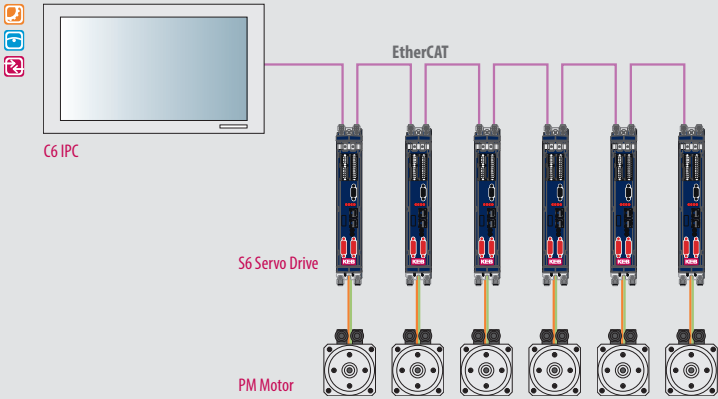
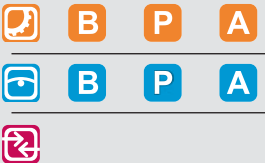

CPU

Processor	Intel® Celeron® J1900, 2.00 GHz (2.42 GHz Burst), 2 MB L2 cache, 4 cores, 4 threads
System memory	RAM 2 GB (1 x SODIMM DDR3 Module)
Graphic controller	Intel® HD Graphics integrated in Intel® Celeron™ microprocessor, 688 MHz

MASS MEMORY

mSATA	32 GB for operating system and runtime environments (internal, not removable)
Cfast slot	16 GB or expandable memory sizes as project memory for free use

OPERATING DATA

Power supply	18 . . . 32 V DC (isolated power supply)
Operating environment	0 . . . 50 °C, Rel. humidity 80 % (without condensation)
Storage conditions	-20 . . . 60 °C, Rel. humidity 80 % (without condensation)
Protection class	IP66 front

OPERATING SYSTEM

Windows Embedded Standard 7P 32 Bit

APPROVALS

CE (EN 55022, EN 61000-3-2/3, EN 55024, EN 60950-1), cULus LISTED (UL508)

PANEL resistive

Display size	10.4"	12.1"	15"	17"	19"
Format	4:3	4:3	4:3	5:4	5:4
Resolution	800 x 600	800 x 600	1024 x 768	1280 x 1024	1280 x 1024
Colours	16 M	16 M	16 M	16 M	16 M
Brightness	400 cd/m ²	500 cd/m ²	500 cd/m ²	350 cd/m ²	350 cd/m ²
Viewing angle (L:R/O:U)	160°, 140°	160°, 140°	170°, 170°	170°, 160°	170°, 170°
Touch technology	Resistive 5 wire				
Front panel	Aluminium. Polycarbonate				

PANEL WIDE resistive

Display size	10.1"W	12.1"W	15.6"W	18.5"W	21.5"W	24"W
Format	16:10	16:10	16:9	16:9	16:9	16:9
Resolution	1280 x 800	1280 x 800	1366 x 768	1366 x 768	1920 x 1080	1920 x 1080
Colours	16 M	16 M	16 M	16 M	16 M	16 M
Brightness	400 cd/m ²	400 cd/m ²	400 cd/m ²	300 cd/m ²	300 cd/m ²	300 cd/m ²
Viewing angle (L:R/O:U)	160°, 160°	176°, 176°	170°, 160°	150°, 140°	178°, 178°	178°, 178°
Touch technology	Resistive 5 wire					
Front panel	Aluminum. Polycarbonat					

PANEL WIDE capacitive

Display size	10.1"W	12.1"W	15.6"W	18.5"W	21.5"W
Format	16:10	16:10	16:9	16:9	16:9
Resolution	1280 x 800	1280 x 800	1366 x 768	1366 x 768	1920 x 1080
Colours	16 M	16 M	16 M	16 M	16 M
Brightness	400 cd/m ²	400 cd/m ²	300 cd/m ²	300 cd/m ²	300 cd/m ²
Viewing angle (L:R/O:U)	170°, 170°	176°, 176°	170°, 160°	170°, 160°	178°, 178°
Touch technology	Capacitive 4 Finger				
Front panel	Aluminium, Glass				

C6 E22 PANEL

PANEL SL

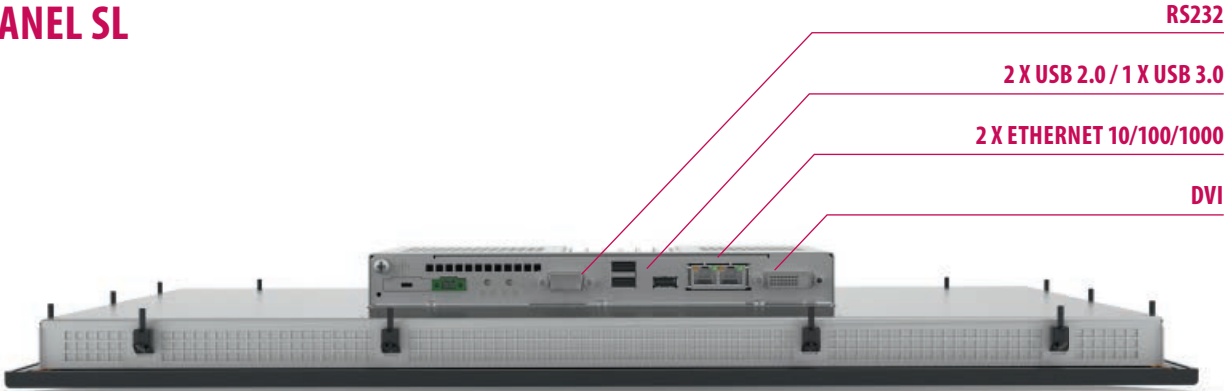

PANEL S1

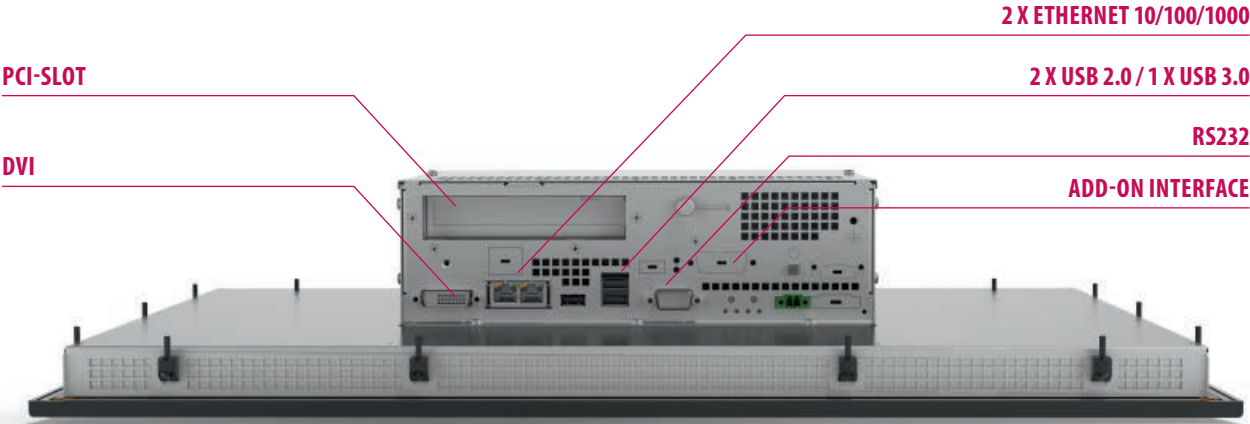

INTERFACES	SL	S1
Ethernet / EtherCAT®	2 x Ethernet 10/100/1000 Mbps (2 x Intel® I210)	2 x Ethernet 10/100/1000 Mbps (2 x Intel® I210)
USB on front	1 x USB 2.0 (resistive)	1 x USB 2.0 (resistive)
USB on back	1 x USB 3.0, 2 x USB 2.0	1 x USB 3.0, 2 x USB 2.0
Serial interface	1 x RS232 (DB9M)	1 x RS232 (DB9M)
Monitor output	1 x DVI-I (DVI-D + VGA, for VGA an adapter is required)	1 x DVI-I (DVI-D + VGA, for VGA an adapter is required)
Expansion slot	-	1 x PC (for fieldbus cards)
Add-on interface	-	1 x RS232/422/485 opto isolated + 1 x USB 2.0 (Type -A) 1 x Ethernet 10/100/1000 Mbps

	LCD TFT	A	B	C	D	E1L	E1H	E2	F (SL/S1)	G	H
Resistive	10,1"W	293	212	277	196	8	8	8	29 / -	19	5
	10,4"	300	245	280	225	10	10	10	29 / 77	19	5
	12,1"	335	270	315	250	10	10	10	29 / 77	19	5
	12,1"W	331	234	313	216	9	9	9	29 / 77	21	5
	15"	390	315	370	295	10	10	10	29 / 77	19	6
	15,6"W	430	275	410	255	10	10	10	29 / 77	19	6
	17"	455	355	435	335	10	10	10	29 / 77	21	6
	18,5"W	500	320	480	300	10	10	10	29 / 77	21	6
	19"	490	388	470	368	10	10	10	29 / 77	23	6
	21,5"W	579	367	559	347	10	10	10	29 / 77	23	6
24"W	640	402	620	382	10	10	10	29 / 77	21,3	8	
Capacitive	10,1"W	293	212	277	196	8	8	8	29 / -	20	5
	12,1"W	331	222,5	313	216	9	9	9	29 / 77	22	5
	15,6"W	433	280,5	410	255	15	10,5	11,5	29 / 77	36	6
	18,5"W	503	320,5	480	300	10	10,5	11,5	29 / 77	35	6
	21,5"W	581,5	367,5	559	347	10	10,5	11,5	29 / 77	35	8
	24"W	640	402	620	382	10	10	10	29/77	21	8

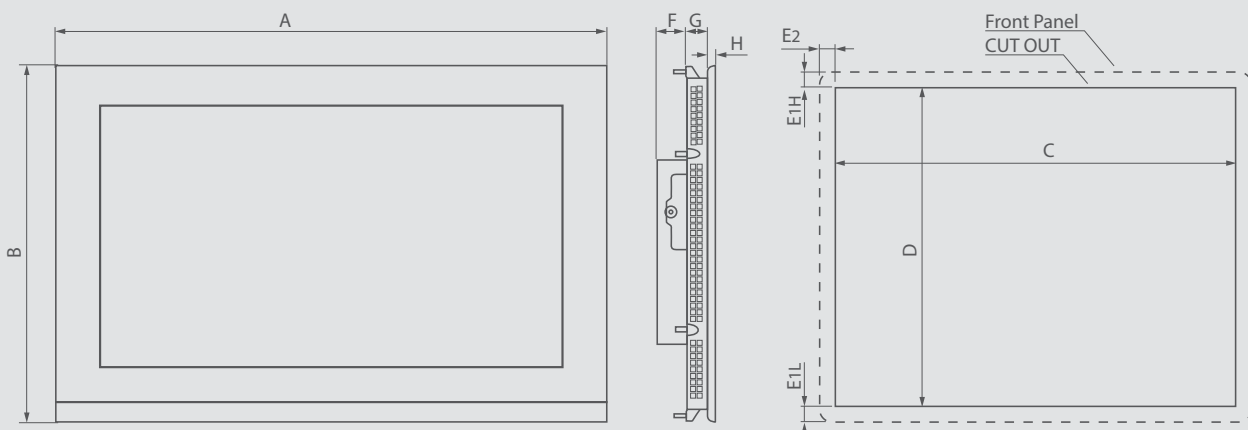

C6 E22 BOX

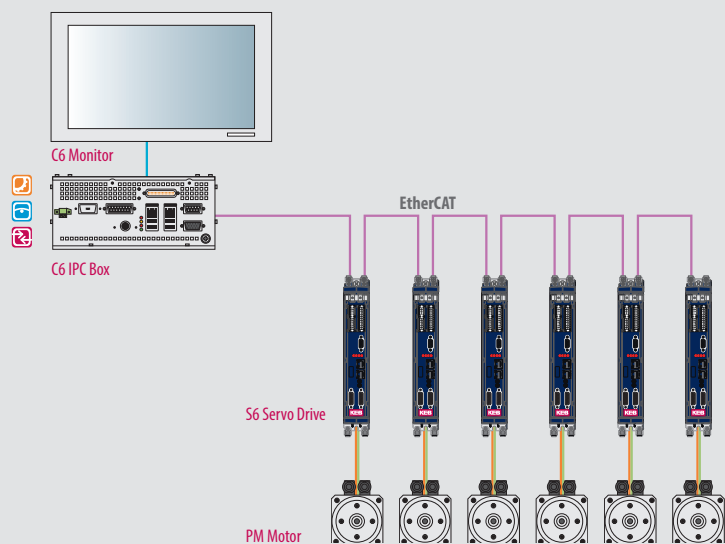
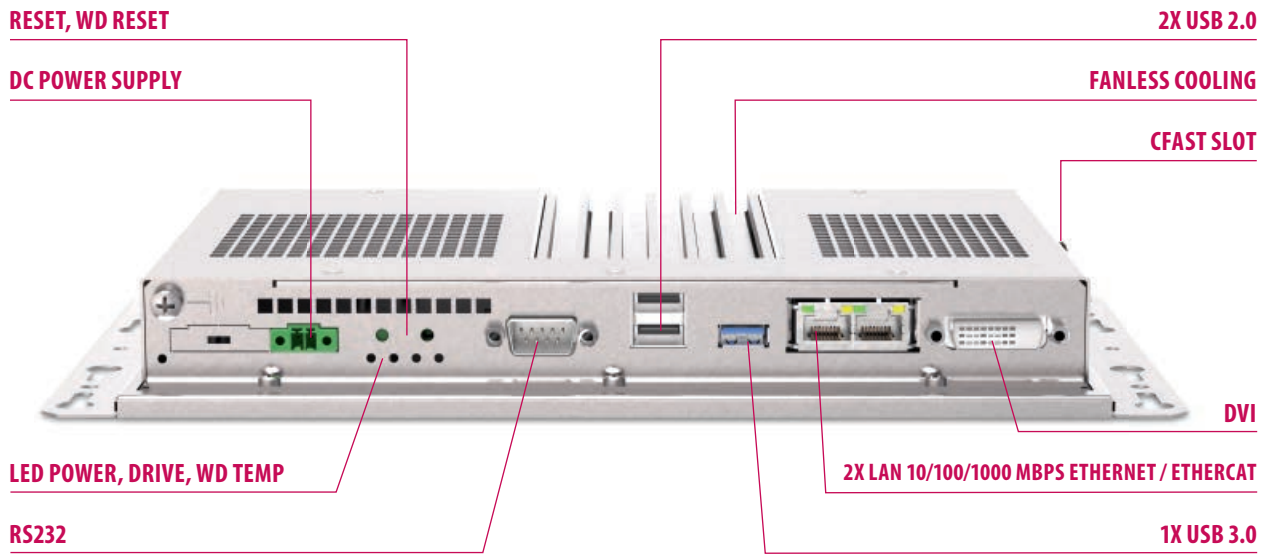

CPU

Processor	Intel® Celeron® J1900, 2.00 GHz (2.42 GHz Burst), 2 MB L2 cache, 4 cores, 4 threads
System memory	RAM 2 GB (1 x SODIMM DDR3 Module)
Graphic controller	Intel® HD Graphics integrated in Intel® Celeron™ microprocessor, 688 MHz

MASS MEMORY

mSATA	32 GB for operating system and runtime environments (internal, not removable)
Cfast slot	16 GB or expandable memory sizes as project memory for free use

OPERATING DATA

Power supply	18 . . . 32 V DC (isolated power supply)
Operating environment	0 . . . 50 °C, Rel. humidity 80 % (without condensation)
Storage conditions	-20 . . . 60 °C, Rel. humidity 80 % (without condensation)
Protection class	IP20

OPERATING SYSTEM

Windows Embedded Standard 7P 32 Bit

APPROVALS

CE (EN 55022, EN 61000-3-2/3, EN 55024, EN 60950-1), cULus LISTED (UL508)

C6 E22 BOX

BOX SL

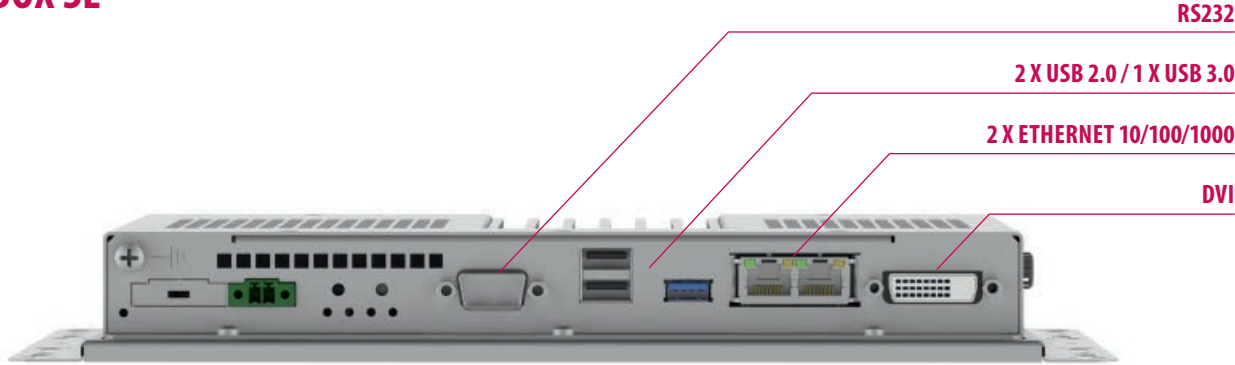

BOX S1

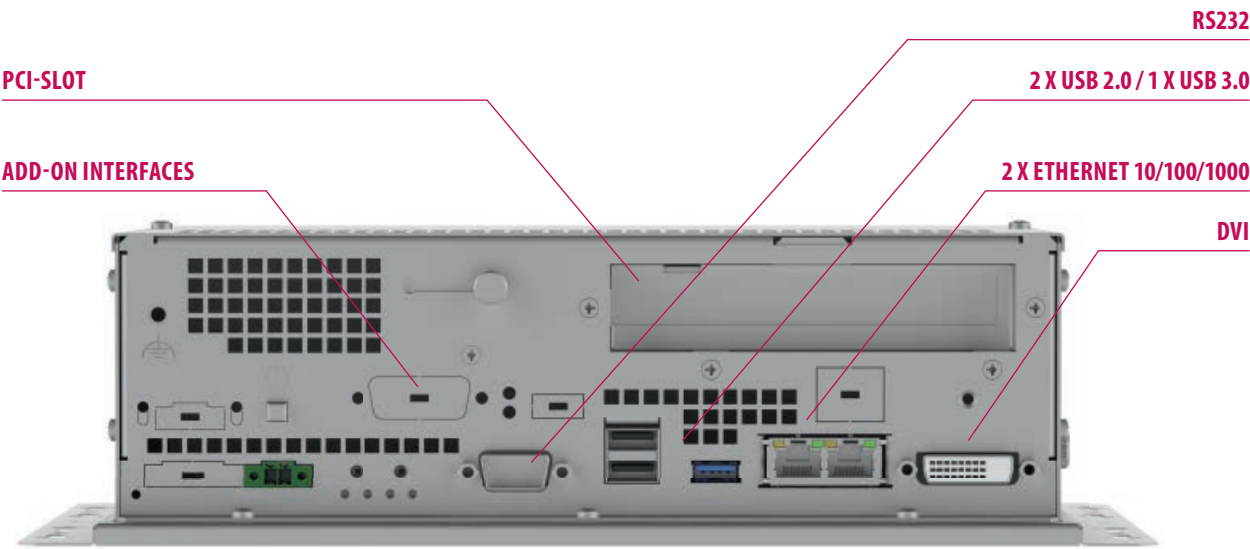

INTERFACES	SL	S1
Ethernet / EtherCAT®	2 x Ethernet 10/100/1000 Mbps (2 x Intel® I210)	2 x Ethernet 10/100/1000 Mbps (2 x Intel® I210)
USB on back	1 x USB 3.0, 2 x USB 2.0	1 x USB 3.0, 2 x USB 2.0
Serial interface	1 x RS232 (DB9M)	1 x RS232 (DB9M)
Monitor output	1 x DVI-I (DVI-D + VGA, for VGA an adapter is required)	1 x DVI-I (DVI-D + VGA, for VGA an adapter is required)
Expansion slot	-	1 x PC (for fieldbus cards)
Add-on interface	-	1 x RS232/422/485 opto isolated + 1 x USB 2.0 (Type -A) 1 x Ethernet 10/100/1000 Mbps

	TYPE	A	B	C	D	E	F	G	H
SL	Box	303.4	185	35	6	29	20.2	253	5
S1	Box	303.4	215.5	82.8	6	76.8	20.2	253	5

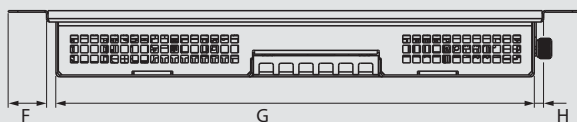
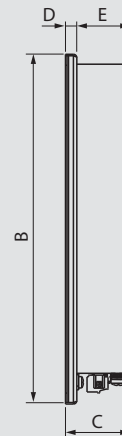
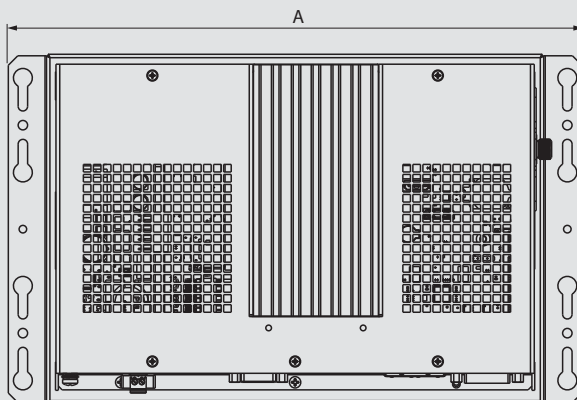

C6 E22 BM

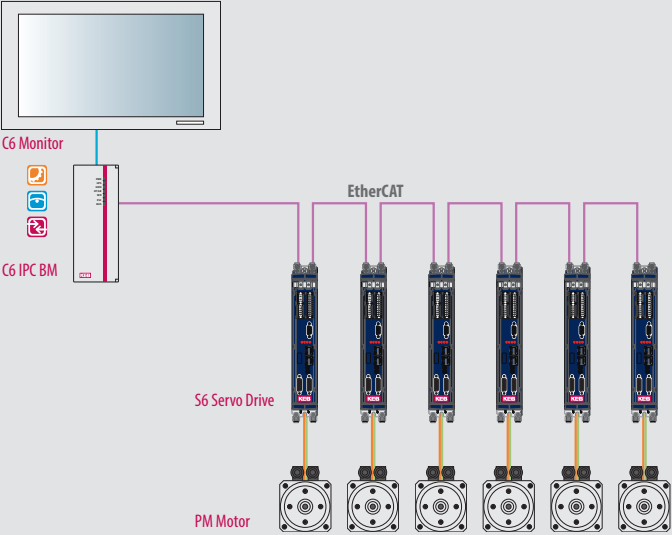
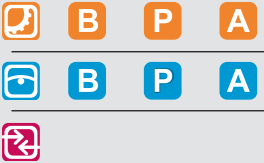

CPU

Processor	Intel® Celeron® J1900, 2.00 GHz (2.42 GHz Burst), 2 MB L2 cache, 4 cores, 4 threads
System memory	RAM 2 GB (1 x SODIMM DDR3 Module)
Graphic controller	Intel® HD Graphics integrated in Intel® Celeron™ microprocessor, 688 MHz

MASS MEMORY

mSATA	32 GB for operating system and runtime environments (internal, not removable)
Cfast slot	16 GB or expandable memory sizes as project memory for free use

OPERATING DATA

Power supply	18 . . . 32 V DC (isolated power supply)
Operating environment	0 . . . 50 °C, Rel. humidity 80 % (without condensation)
Storage conditions	-10 . . . 60 °C, Rel. humidity 80 % (without condensation)
Protection class	IP20

OPERATING SYSTEM

Windows Embedded Standard 7P 32 Bit

APPROVALS

CE (EN 55022, EN 61000-3-2/3, EN 55024, EN 60950-1), cULus LISTED (UL61010)

C6 E22 BM

DC POWER SUPPLY

2 X ETHERNET (10/100/1000 MBPS)

DVI

2 X USB 2.0 (TYPE A)



POWER ON
UPS
HDD ACTIVITY
OVER TEMPERATURE / BATTERY FAULT
WATCHDOG / FACTORY RESET
STATUS PLC
STATUS BUS

POWER ON RESET
SYSTEM RESET
WATCHDOG RESET
PLC RUN / STOP / RESET
USB 3.0

BACKUP BATTERY

CFAST MEMORY



INTERFACES	DVI	RVL
Ethernet / EtherCAT®	2 x Ethernet 10/100/1000 Mbps (2 x Intel® I210)	2 x Ethernet 10/100/1000 Mbps (2 x Intel® I210)
USB	2 x USB 2.0 (Typ A)	2 x USB 2.0 (Typ A)
USB on front	1 x USB 3.0	1 x USB 3.0
Serial interface	-	-
Monitor output	1 x DVI-I	1 x RVL out (RJ45)
Add-on interface	1 x RS232/422/485 1 x Ethernet 10/100/1000 Mbps	1 x RS232/422/485 1 x Ethernet 10/100/1000 Mbps

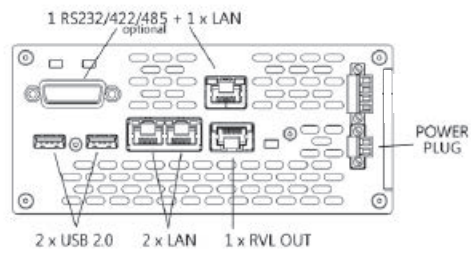
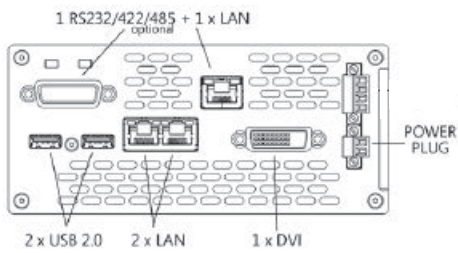
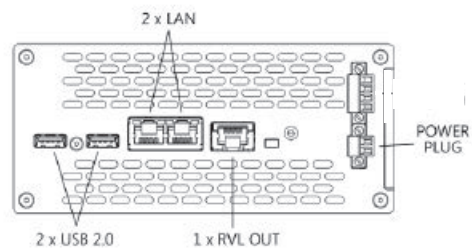
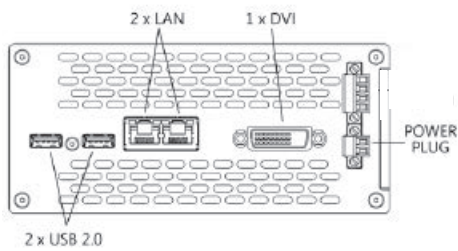

TYPE	A	B	C	D	E
BM	71	220	159.5	19	182

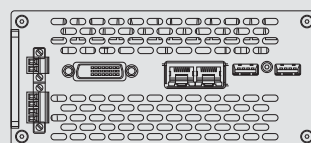
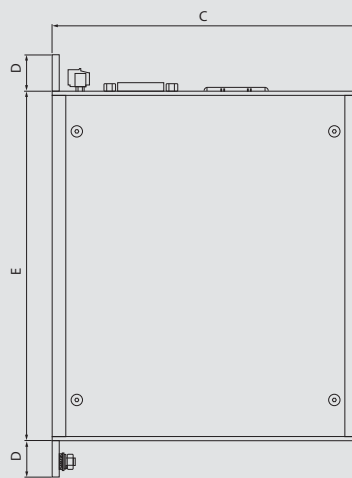
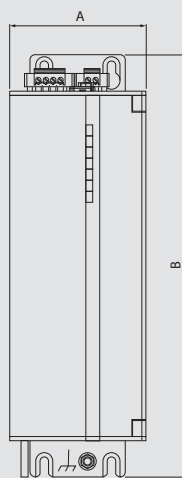

C6 P33



HIGHLIGHTS

- Fanless IPC book mounted up to 50 °C operating temperature
- Intel® Skylake U-Plattform
 - Celeron® Dual Core 3955U 2 Ghz, 2 Cores, 2 Threads
- Smart memory concept for maximum flexibility in application
- Synchronous realtime control with EtherCAT Master
- Micro UPS for secure of non volatile memory

C6 P33 BM

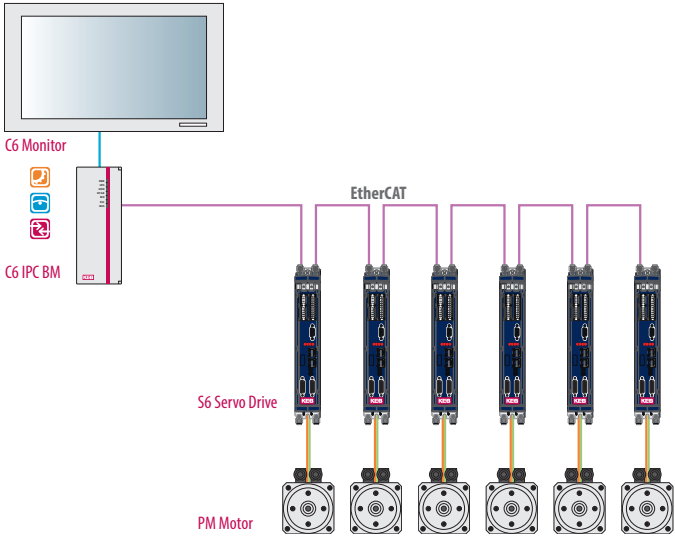
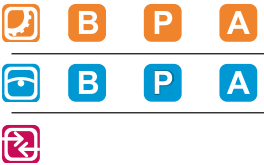

CPU

Processor	Intel® Celeron® 3955U, 2,00 GHz 64 bit, 2 MB Smart cache, 2 cores, 2 threads
System memory	RAM 4 GB (1 x SODIMM DDR4 Module)
Graphic controller	Intel® HD Graphics 510 integrated in Celeron 3955U processor, 300MHz/900MHz

MASS MEMORY

mSATA	32 GB for operating system and runtime environments (internal, not removable)
Cfast slot	16 GB or expandable memory sizes as project memory for free use

OPERATING DATA

Power supply	18 . . . 32 V DC (isolated power supply)
Operating environment	0 . . . 50 °C, Rel. humidity 80 % (without condensation)
Storage conditions	-10 . . . 60 °C, Rel. humidity 80 % (without condensation)
Protection class	IP20

OPERATING SYSTEM

Windows Embedded Standard 7P 32 Bit

APPROVALS

CE (EN 55022, EN 61000-3-2/3, EN 55024, EN 60950-1), cULus LISTED (UL61010)

C6 P33 BM

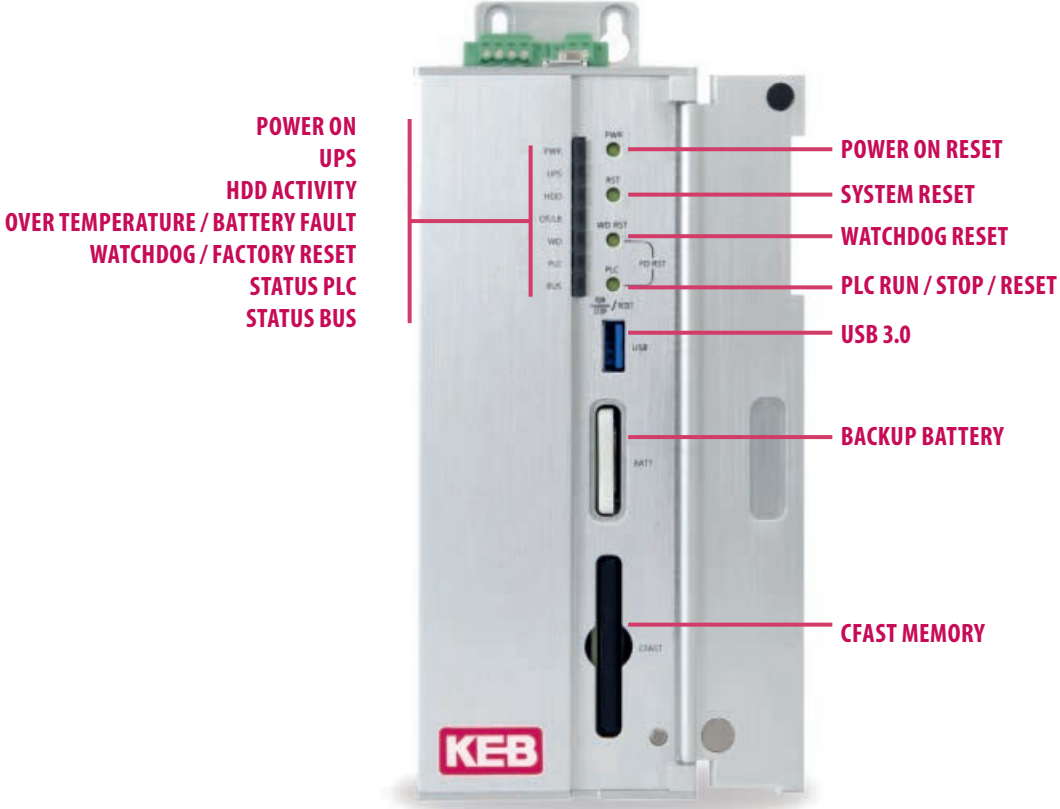
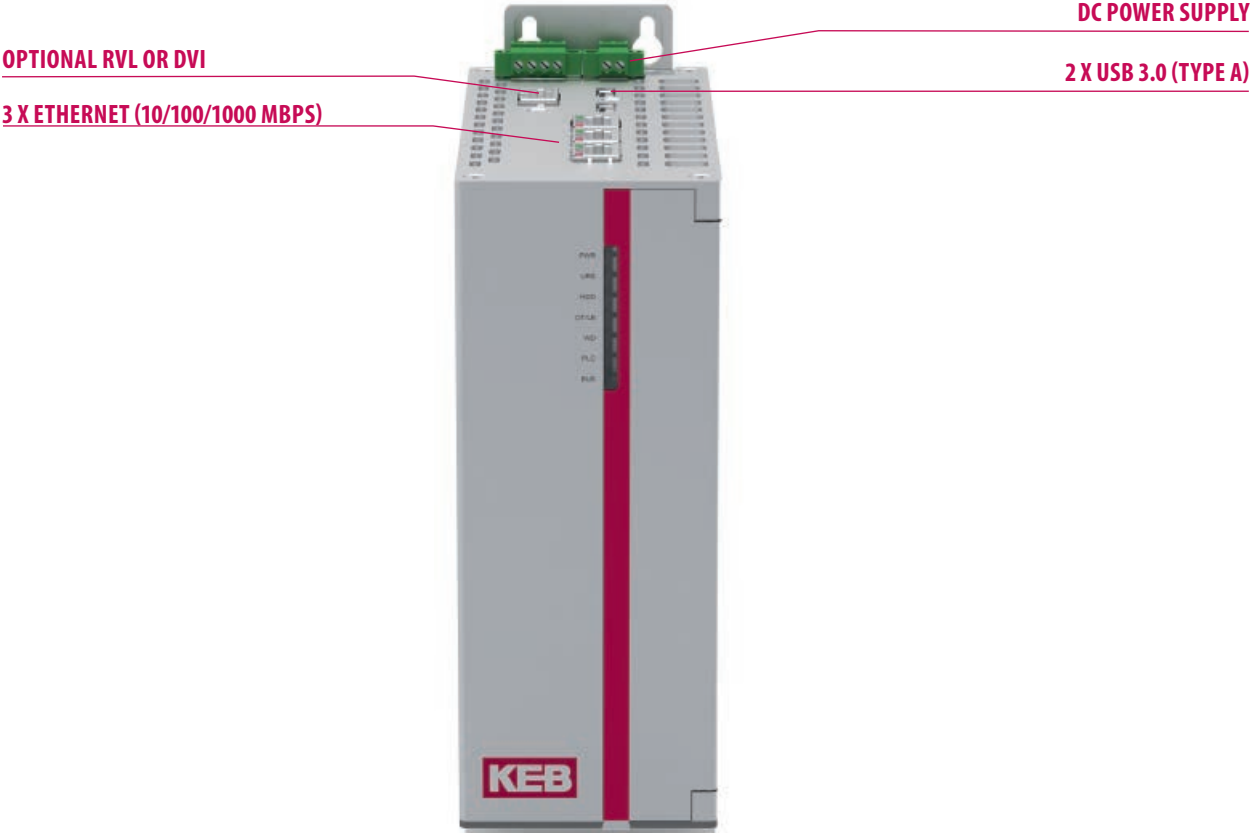

INTERFACES	DVI	RVL
Ethernet / EtherCAT®	3 x Ethernet 10/100/1000 Mbps (2 x Intel® I210, 1 x Intel® I219LM)	3 x Ethernet 10/100/1000 Mbps (2 x Intel® I210, 1 x Intel® I219LM)
USB	2 x USB 3.0 (Typ A)	2 x USB 3.0 (Typ A)
USB on front	1 x USB 3.0	1 x USB 3.0
Serial interface	-	-
Monitor output	1 x DVI-D	1 x RVL out (RJ45)
Add-on interface	1 x RS232/422/485 + 1 x USB 2.0	1 x RS232/422/485 + 1 x USB 2.0

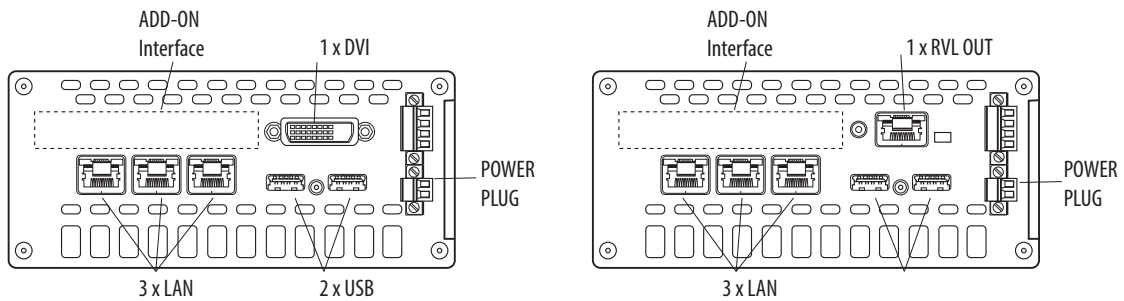

TYPE	A	B	C	D	E
BM	71	220	159.5	19	182

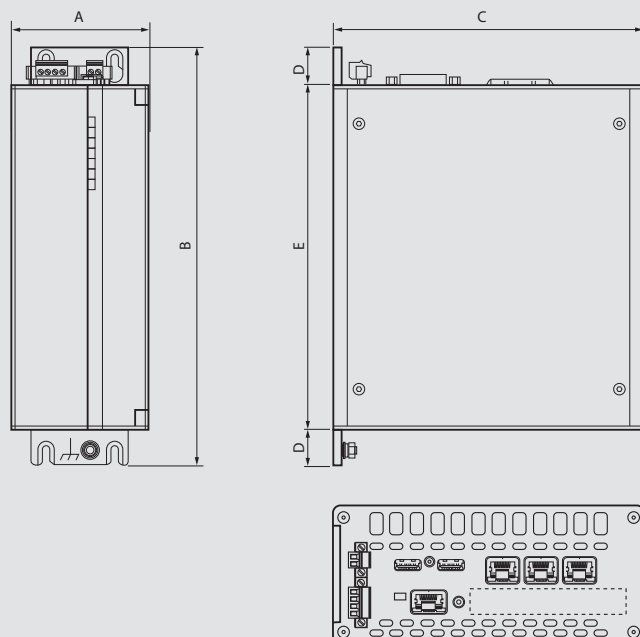

C6 P34



HIGHLIGHTS

- Fanless IPC with high-performance processor up to 50 °C operating temperature
- Intel® Skylake Platform (Core i)
 - Core i5-6440EQ 2,70 GHz, Quad Core - 4 Threads
- Displays with resistive or capacitive touch technology
 - 4:3 Format: 12.1", 15", 17" (5:4), 19" (5:4); 16:9 Format: 12.1" (16:10), 15.6", 18.5", 21.5", 24"
- Smart memory concept for maximum flexibility in use

C6 P34 PANEL



GLASS FRONT

CAPACITIVE TOUCH TECHNOLOGY

PROTECTION CLASS IP66

FULL HD RESOLUTION

4:3 AND 16:9 FORMATS

RESISTIVE TOUCH TECHNOLOGY

USB ON FRONT

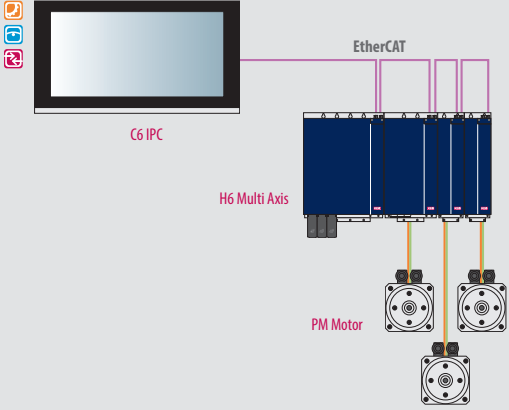
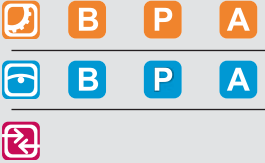

CPU

Processor	Intel® Core™ i5-6440EQ, 2,70 GHz (3.40 GHz Turbo), 6MB smart cache, 4 cores, 4 threads, Soldered on-board
System memory	RAM 4 GB (1 x SODIMM DDR4-2133)
Graphic controller	Intel® HD Graphics 510 integrated into Intel® Celeron™ microprocessor, 950MHz

MASS MEMORY

mSATA	32 GB for operating system and runtime environments (internal, not removable)
Cfast slot	16 GB or expandable memory sizes as project memory for free use

OPERATING DATA

Power supply	18 . . . 32 V DC (isolated power supply)
Operating environment	0 . . . 50 °C, Rel. humidity 80 % (without condensation)
Storage conditions	-20 . . . 60 °C, Rel. humidity 80 % (without condensation)
Protection class	IP66 front

OPERATING SYSTEM

Windows Embedded Standard 7P 32 Bit

APPROVALS

CE (EN 55022, EN 61000-3-2/3, EN 55024, EN 60950-1), cULus LISTED (UL61010) pending

PANEL resistive

Display size	12.1"	15"	17"	19"
Format	4:3	4:3	5:4	5:4
Resolution	800 x 600	1024 x 768	1280 x 1024	1280 x 1024
Colours	16 M	16 M	16 M	16 M
Brightness	450 cd/m ²	500 cd/m ²	350 cd/m ²	350 cd/m ²
Viewing angle (L:R/O:U)	160°, 140°	170°, 170°	170°, 160°	170°, 170°
Touch technology	Resistive 5 wire			
Front panel	Aluminium. Polycarbonate			

PANEL WIDE resistive

Display size	12.1"W	15.6"W	18.5"W	21.5"W	24"W
Format	16:10	16:9	16:9	16:9	16:9
Resolution	1280 x 800	1366 x 768	1366 x 768	1920 x 1080	1920 x 1080
Colours	16 M	16 M	16 M	16 M	16 M
Brightness	400 cd/m ²	400 cd/m ²	300 cd/m ²	300 cd/m ²	300 cd/m ²
Viewing angle (L:R/O:U)	176°, 176°	160°, 160°	150°, 140°	178°, 178°	178°, 178°
Touch technology	Resistive 5 wire				
Front panel	Aluminum. Polycarbonat				

PANEL WIDE capacitive

Display size	12.1"W	15.6"W	18.5"W	21.5"W	24"W
Format	16:10	16:9	16:9	16:9	16:9
Resolution	1280 x 800	1366 x 768	1366 x 768	1920 x 1080	1920 x 1080
Colours	16 M	16 M	16 M	16 M	16 M
Brightness	400 cd/m ²	400 cd/m ²	300 cd/m ²	300 cd/m ²	300 cd/m ²
Viewing angle (L:R/O:U)	176°, 176°	160°, 160°	150°, 140°	178°, 178°	178°, 178°
Touch technology	Capacitive 4 Finger				
Front panel	Aluminium, Glass				

C6 P34 PANEL

PANEL S0

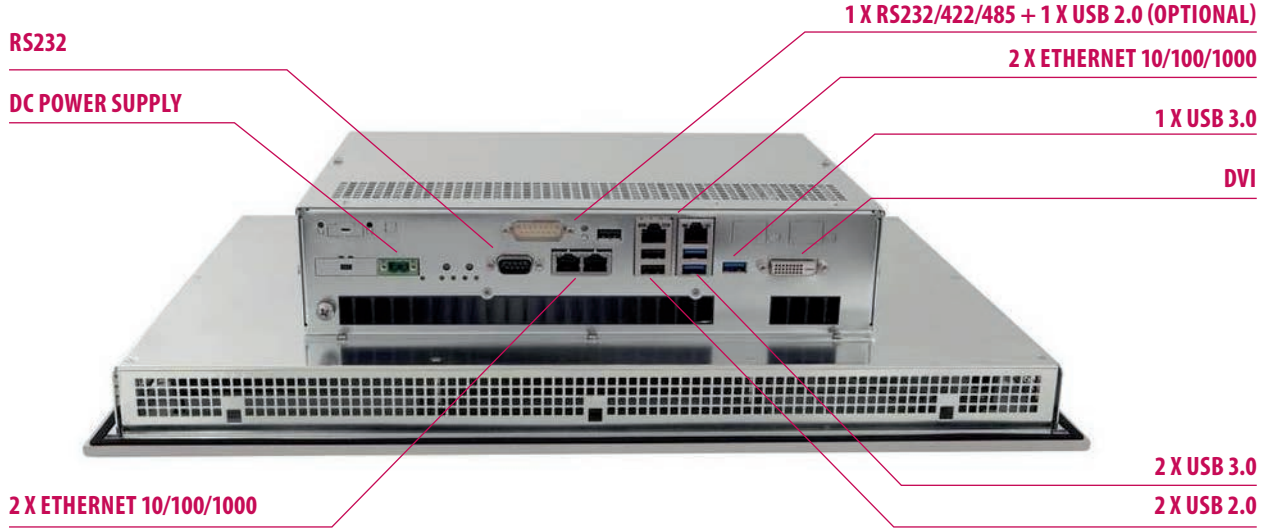

PANEL S1

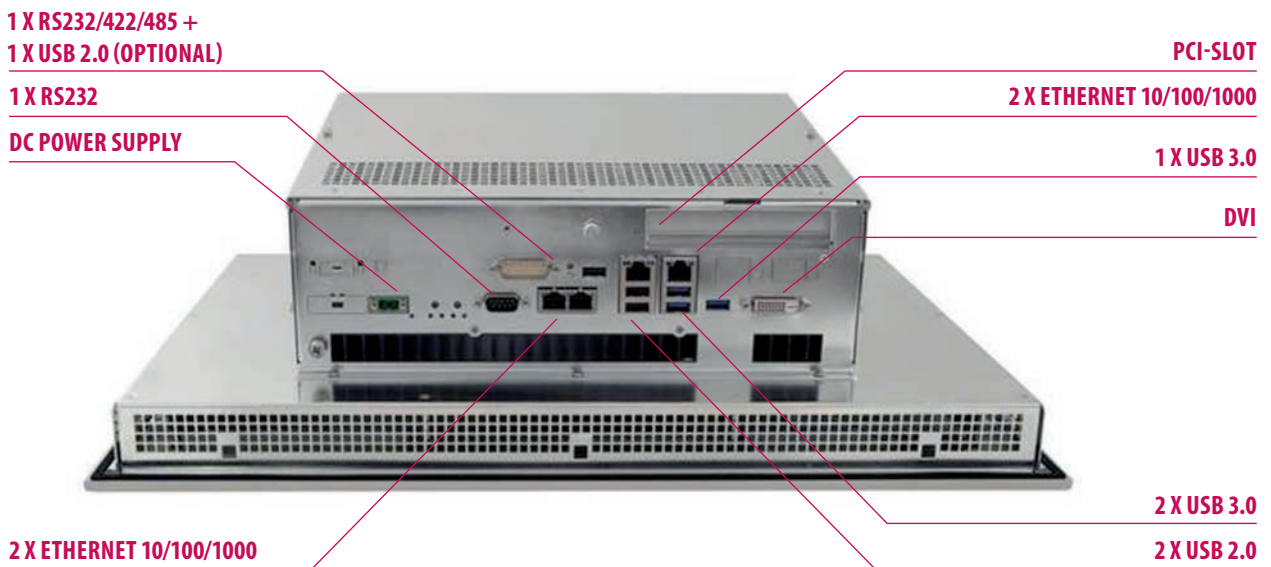

INTERFACES	S0	S1
Ethernet / EtherCAT®	4 x Ethernet 10/100/1000 Mbps (3 x Intel® I210 + 1 x Intel® I219LM)	4 x Ethernet 10/100/1000 Mbps (3 x Intel® I210 + 1 x Intel® I219LM)
USB on back	3 x USB 3.0 (Type A), 2 x USB 2.0 (Type A)	3 x USB 3.0 (Type A), 2 x USB 2.0 (Type A)
Serial interface	1 x RS232 (DB9M)	1 x RS232 (DB9M)
Monitor output	1 x DVI-D	1 x DVI-D
Expansion slot	-	1 x PCI (for fieldbus cards)
Add-on interface	1 x RS232/422/485 opto isolated + 1 x USB 2.0 (Type -A)	1 x RS232/422/485 opto isolated + 1 x USB 2.0 (Type -A)

	LCD TFT	A	B	C	D	E1L	E1H	E2	F (S0/S1)	G	H
Resistive	12,1"	335	270	315	250	10	10	10	70 / 100	19	5
	12,1"W	331	234	313	216	9	9	9	70 / 100	21	5
	15"	390	315	370	295	10	10	10	70 / 100	19	6
	15,6"W	430	275	410	255	10	10	10	70 / 100	19	6
	17"	455	355	435	335	10	10	10	70 / 100	21	6
	18,5"W	500	320	480	300	10	10	10	70 / 100	21	6
	19"	490	388	470	368	10	10	10	70 / 100	23	6
	21,5"W	579	367	559	347	10	10	10	70 / 100	23	6
	24"W	640	402	620	382	10	10	10	70 / 100	21,3	8
Capacitive	12.1"W	331	234	313	218	7	9	9	70 / 100	22	5
	15.6"W	433	280.5	410	255	15	10.5	11.5	70 / 100	36	6
	18.5"W	503	320.5	480	300	10	10.5	11.5	70 / 100	35	6
	21.5"W	581.5	367.5	559	347	10	10.5	11.5	70 / 100	35	8
	24"W	640	402	620	382	10	10	10	70 / 100	21	8

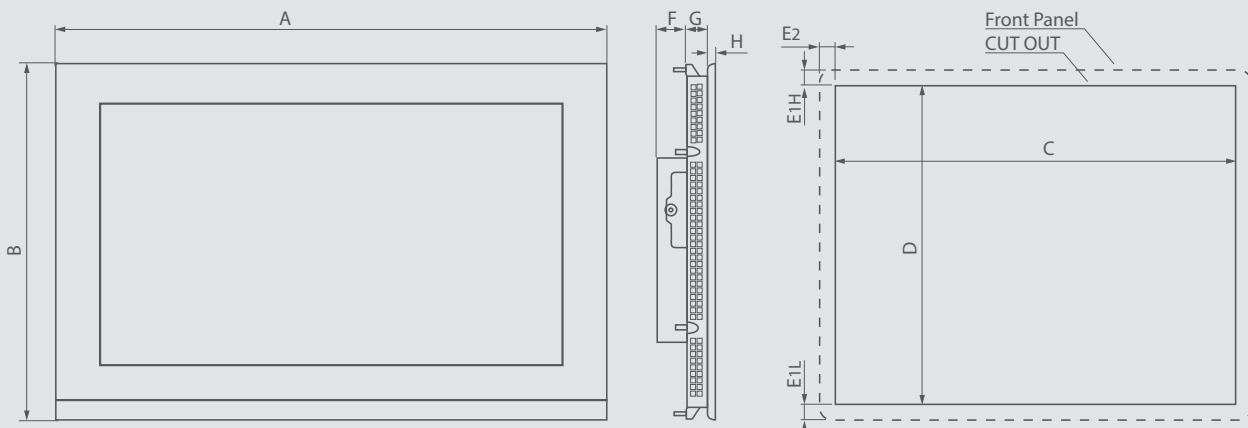

C6 P34 BOX

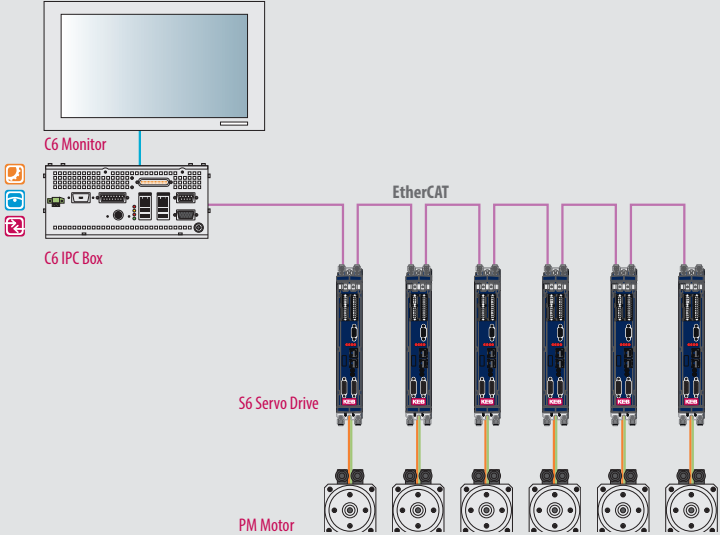
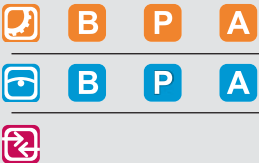

CPU

Processor	Intel® Core™ i5-6440EQ, 2,70 GHz (3.40 GHz Turbo), 6MB smart cache, 4 cores, 4 threads, Soldered on-board
System memory	RAM 4 GB (1 x SODIMM DDR4-2133)
Graphic controller	Intel® HD Graphics 510 integrated into Intel® Celeron™ microprocessor, 950MHz

MASS MEMORY

mSATA	32 GB for operating system and runtime environments (internal, not removable)
Cfast slot	16 GB or expandable memory sizes as project memory for free use

OPERATING DATA

Power supply	18 . . . 32 V DC (isolated power supply)
Operating environment	0 . . . 50 °C, Rel. humidity 80 % (without condensation)
Storage conditions	-20 . . . 60 °C, Rel. humidity 80 % (without condensation)
Protection class	IP66 front

OPERATING SYSTEM

Windows Embedded Standard 7P 32 Bit

APPROVALS

CE (EN 55022, EN 61000-3-2/3, EN 55024, EN 60950-1), cULus LISTED (UL61010) pending

C6 P34 BOX

BOX S0

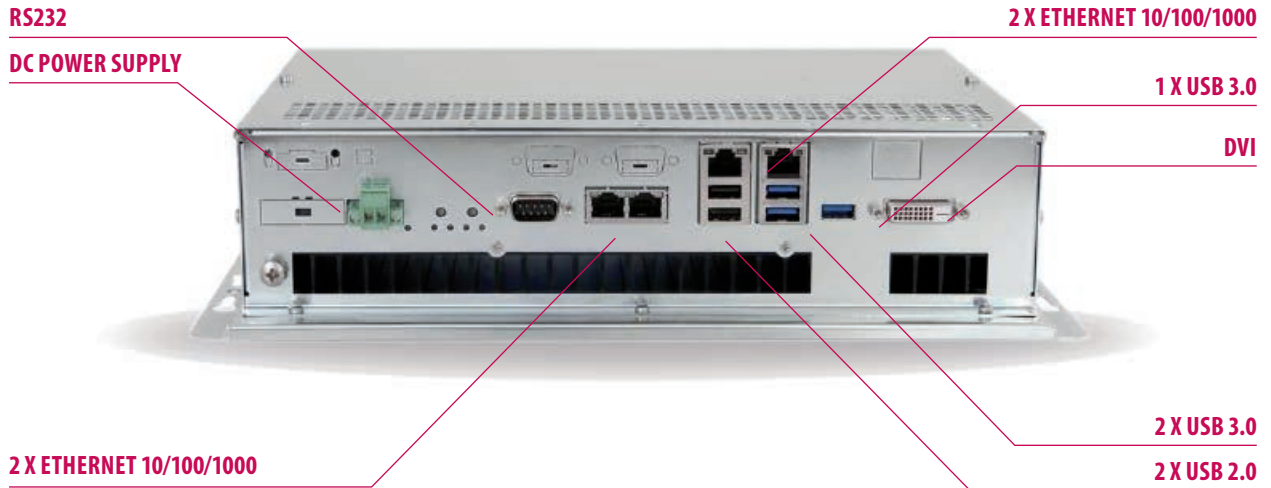

BOX S1

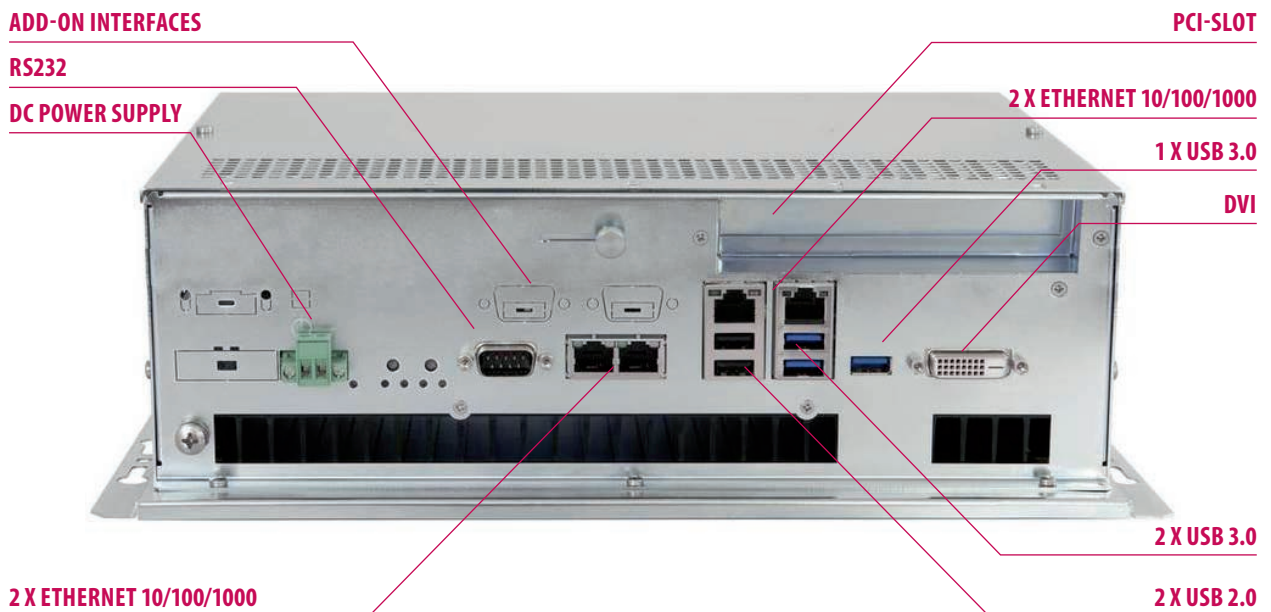

INTERFACES	S0	S1
Ethernet / EtherCAT®	4 x Ethernet 10/100/1000 Mbps (3 x Intel® I210 + 1 x Intel® I219LM)	4 x Ethernet 10/100/1000 Mbps (3 x Intel® I210 + 1 x Intel® I219LM)
USB on back	3 x USB 3.0 (Type A), 2 x USB 2.0 (Type A)	3 x USB 3.0 (Type A), 2 x USB 2.0 (Type A)
Serial interface	1 x RS232 (DB9M)	1 x RS232 (DB9M)
Monitor output	1 x DVI-D	1 x DVI-D
Expansion slot	-	1 x PCI (for fieldbus cards)
Add-on interface	1 x RS232/422/485 opto isolated + 1 x USB 2.0 (Type -A)	1 x RS232/422/485 opto isolated + 1 x USB 2.0 (Type -A)

	TYPE	A	B	C	C1
S0	Box	338.4	246	75.8	-
S1	Box	338.4	246	-	105.8

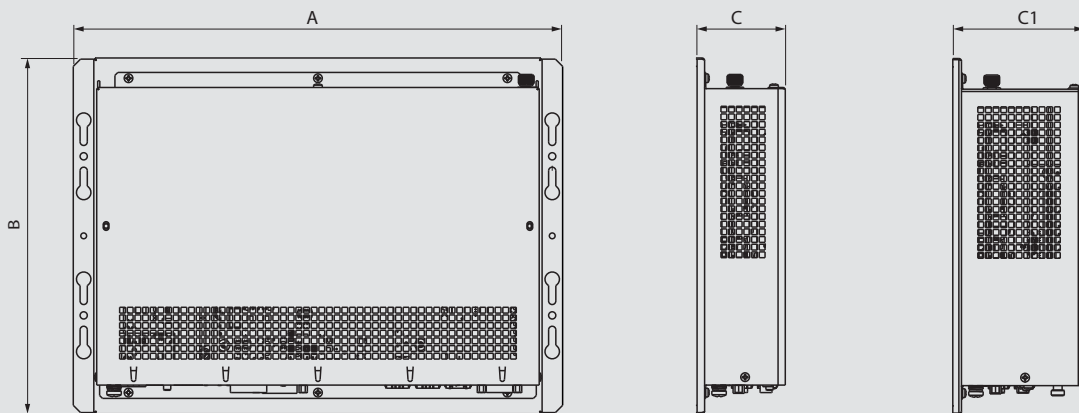

C6 P34 BM

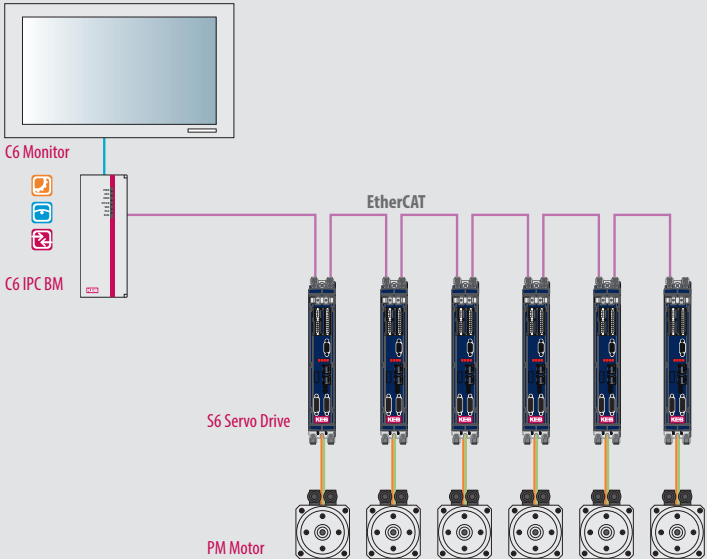
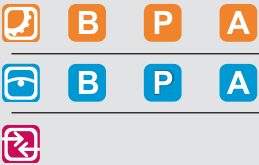

CPU

Processor	Intel® Core™ i5-6440EQ, 2,70 GHz (3.40 GHz Turbo), 6MB smart cache, 4 cores, 4 threads, Soldered on-board
System memory	RAM 4 GB (1 x SODIMM DDR4-2133)
Graphic controller	Intel® HD Graphics 510 integrated into Intel® Celeron™ microprocessor, 950MHz

MASS MEMORY

mSATA	32 GB for operating system and runtime environments (internal, not removable)
Cfast slot	16 GB or expandable memory sizes as project memory for free use

OPERATING DATA

Power supply	18 . . . 32 V DC (isolated power supply)
Operating environment	0 . . . 50 °C, Rel. humidity 80 % (without condensation)
Storage conditions	-10 . . . 60 °C, Rel. humidity 80 % (without condensation)
Protection class	IP20

OPERATING SYSTEM

Windows Embedded Standard 7P 32 Bit

APPROVALS

CE (EN 55022, EN 61000-3-2/3, EN 55024, EN 60950-1), cULus LISTED (UL61010) pending

C6 P34 BM

DC POWER SUPPLY

RVL OUT (OPTIONAL)

2 X ETHERNET (10/100/1000 MBPS)

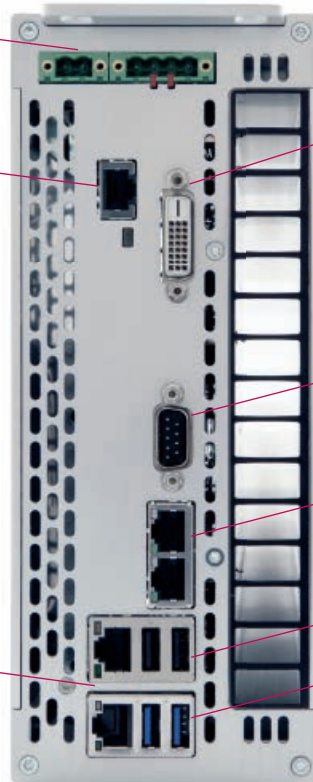

DVI

RS232

2 X ETHERNET (10/100/1000 MBPS)

2 X USB 2.0 (TYPE A)

2 X USB 3.0 (TYPE A)

POWER ON
UPS
HDD ACTIVITY
OVER TEMPERATURE /
BATTERY FAULT
WATCHDOG / FACTORY RESET
STATUS PLC
STATUS BUS

2.5" SATA HDD / SSD
(OPTIONAL)



POWER ON RESET

SYSTEM RESET

WATCHDOG RESET

PLC RUN / STOP / RESET

USB 3.0

BACKUP BATTERY

CFAST MEMORY

INTERFACES	S0 / D0		S0 / D1	
	DVI	RVL	DVI	RVL
Ethernet / EtherCAT®	4 x Ethernet 10/100/1000 Mbps (3 x Intel® I210 + 1 x Intel® I219LM)		4 x Ethernet 10/100/1000 Mbps (3 x Intel® I210 + 1 x Intel® I219LM)	
USB on back	3 x USB 3.0 (Type A), 2 x USB 2.0 (Type A)		3 x USB 3.0 (Type A), 2 x USB 2.0 (Type A)	
Serial interface	1 x RS232 (DB9M)		1 x RS232 (DB9M)	
Monitor output	1 x DVI-D	1 x RVL out (RJ45)	1 x DVI-D	1 x RVL out (RJ45)
Add-on interface	1 x RS232/422/485 opto isolated + 1 x USB 2.0 (Type -A)		1 x RS232/422/485 opto isolated + 1 x USB 2.0 (Type -A)	
HDD / SSD 2,5"	-		1 x HDD / SSD SATA 3	

TYPE	A	B	C	D	E
BM	90	268	225	19	230

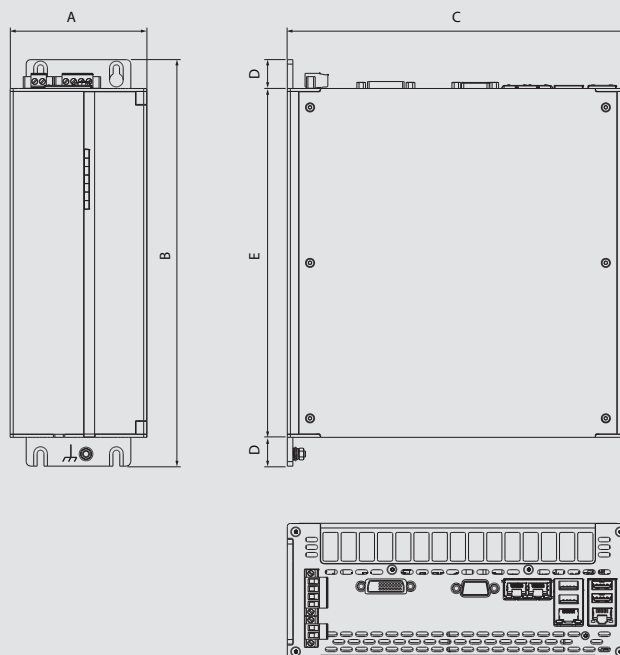

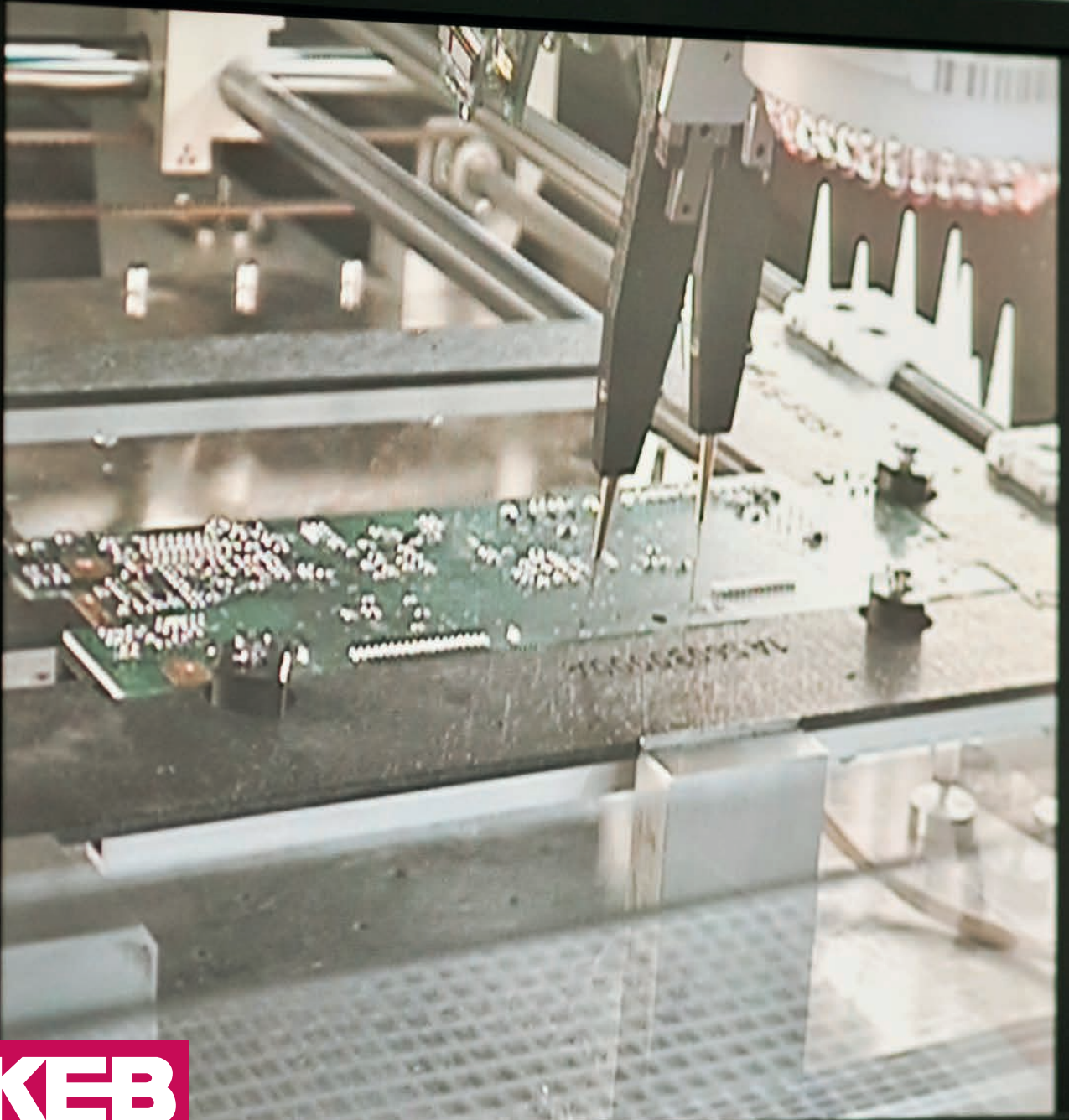

KEB





INDUSTRIAL MONITORS

The industrial monitor series for visualization and operation of applications is used to complete embedded and IPC systems without displays. The series offers a sophisticated design with a wide range of monitor sizes and the choice between resistive and capacitive touch based on the latest technologies, to complete the KEB range.

High protection classes and reliable hardware designed for rough industrial environments distinguish the monitor systems.

- **C6 MONITOR**
- **C6 AMM**

C6 MONITOR



HIGHLIGHTS

- Industrial Touch Monitor with high protection class, 16 million colours, up to full HD resolution and long-term availability
- LED backlight TFT LCD displays with resistive or capacitive touch technology
 - 4:3 format: 12.1", 15", 17" (5:4), 19" (5:4)
 - 16:9 format: 12.1" (16:10), 15.6", 18.5", 21.5", 24"
- Integrated extension module for graphics and touch with only one cable up to 100m

C6 MONITOR

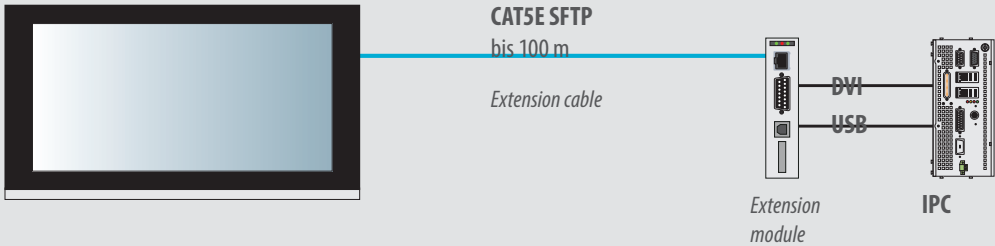
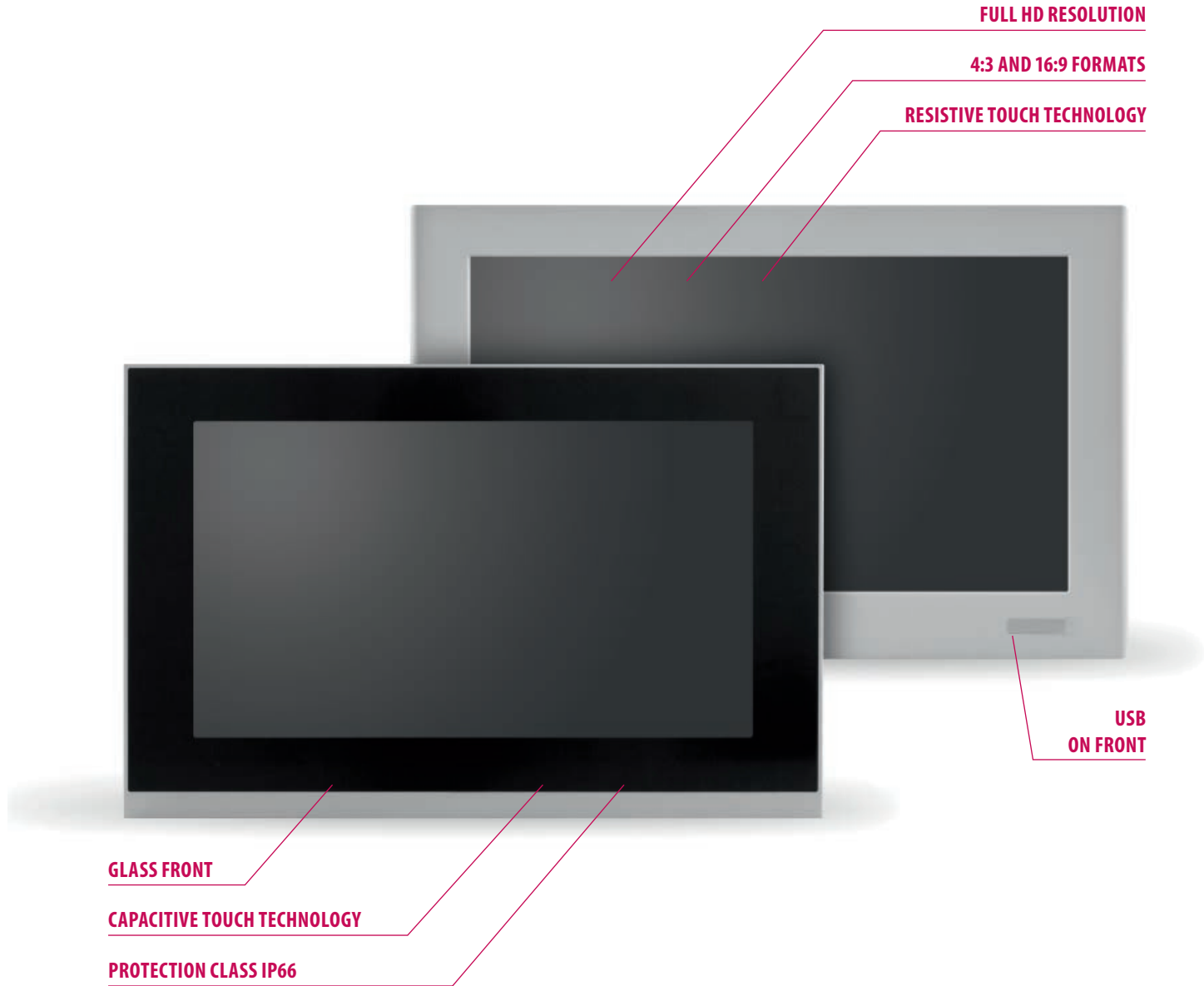

OPERATING DATA

Power supply	18...32 V DC (isolated power supply)
Operating environment	0...50 °C, Rel. humidity 80 % (without condensation)
Storage conditions	-20...60 °C, Rel. humidity 80 % (without condensation)
Protection class	IP66 On front

APPROVALS

CE (EN 55022, EN 61000-3-2/3, EN 55024, EN 60950-1), cULus LISTED (UL508)

PANEL resistive

Display size	12.1"	15"	17"	19"
Format	4:3	4:3	5:4	5:4
Resolution	800 x 600	1024 x 768	1280 x 1024	1280 x 1024
Brightness	500 cd/m ²	500 cd/m ²	350 cd/m ²	350 cd/m ²
Viewing angle (L:R/O:U)	160°, 140°	170°, 170°	170°, 160°	170°, 160°
Touch technology	Resistive 5 wire			
USB on front	1 x USB 2.0			
Front Panel	Aluminium, Polycarbonate			

PANEL WIDE resistive

Display size	10.1"W	12.1"W	15.6"W	18.5"W	21.5"W	24"W
Format	16:10	16:10	16:9	16:9	16:9	16:9
Resolution	1280 x 800	1280 x 800	1366 x 768	1366 x 768	1920 x 1080	1920 x 1080
Brightness	400 cd/m ²	400 cd/m ²	400 cd/m ²	300 cd/m ²	300 cd/m ²	300 cd/m ²
Viewing angle (L:R/O:U)	170°, 170°	176°, 176°	170°, 160°	150°, 140°	178°, 178°	178°, 178°
Touch technology	Resistive 5 wire					
USB on front	1 x USB 2.0					
Front Panel	Aluminium, Polycarbonate					

PANEL WIDE capacitive

Display size	10.1"W	12.1"W	15.6"W	18.5"W	21.5"W	24"W
Format	16:10	16:10	16:9	16:9	16:9	16:9
Resolution	1280 x 800	1280 x 800	1366 x 768	1366 x 768	1920 x 1080	1920 x 1080
Brightness	400 cd/m ²	400 cd/m ²	400 cd/m ²	300 cd/m ²	300 cd/m ²	300 cd/m ²
Viewing angle (L:R/O:U)	170°, 170°	176°, 176°	170°, 170°	150°, 140°	178°, 178°	178°, 178°
Touch technology	Capacitive 4 Finger					
USB on front	-					
Front Panel	Aluminium, Glass					

C6 MONITOR

DVI

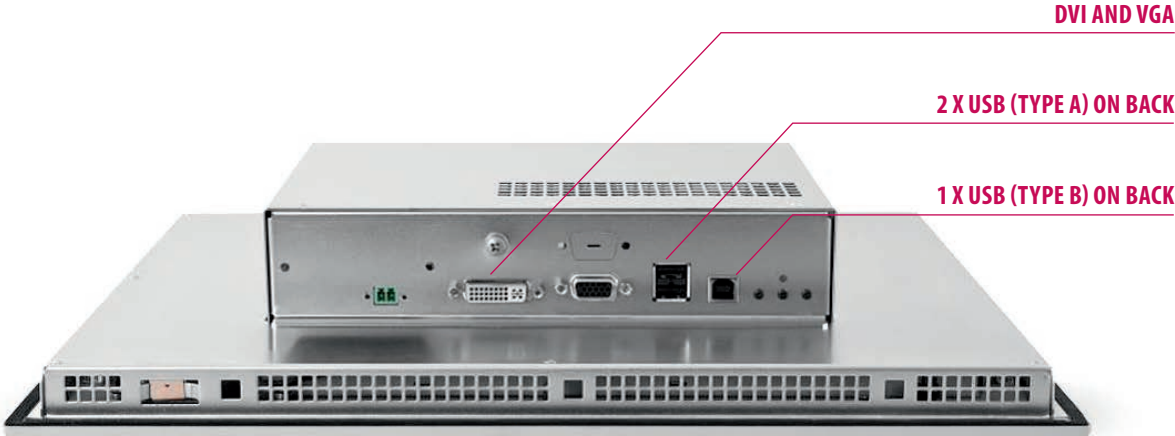

RVL

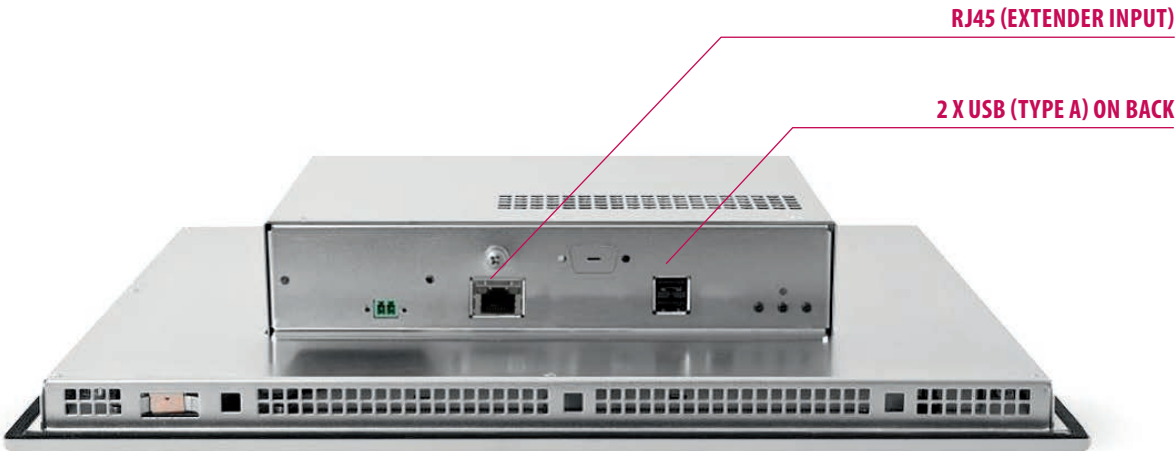

INTERFACES	DVI	RVL
USB on back	2 x USB 2.0 (Type A) + 1 x USB 2.0 (Type B)	2 x USB 2.0 (Type A)
Standard Version up to 10 m Monitor input	1 x DVI-I and 1x VGA	-
Extended Version up to 100 m Extender input	-	1 x RJ45 (Extender input)

	LCD TFT	A	B	C	D	E1L	E1H	E2	F	G	H
Resistive	10.1"W	293	212	277	196	8	8	8	45	19	5
	12.1"	335	270	315	250	10	10	10	45	19	5
	12.1"W	331	234	313	218	9	9	9	45	21	5
	15"	390	315	370	295	10	10	10	45	19	6
	15.6"W	430	275	410	255	10	10	10	45	19	6
	17"	455	355	435	335	10	10	10	45	21	6
	18.5"W	500	320	480	300	10	10	10	45	19	6
	19"	490	388	470	368	10	10	10	45	21	6
	21.5"W	579	367	559	347	10	10	10	45	23	6
24"W	640	402	620	382	10	10	10	45	21.3	8	
Capacitive	10.1"W	293	212	277	196	8	8	8	45	19	5
	12.1"W	331	234	313	218	7	9	9	45	23	5
	15.6"W	433	280.5	410	255	15	10.5	11.5	45	36	6
	18.5"W	503	320.5	480	300	10	10.5	11.5	45	35	6
	21.5"W	581.5	367.5	559	347	10	10.5	11.5	45	35	8
	24"W	640	402	620	382	10	10	10	45	21	8

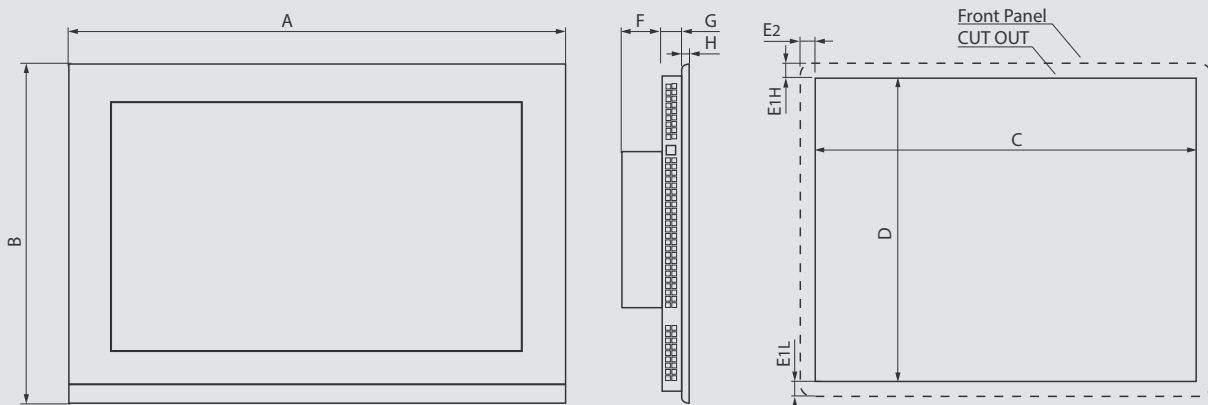

C6 AMM



HIGHLIGHTS

- Resistive or capacitive touch panel upto in four wide screen formats
- Fully enclosed housing protection class IP65
- Individually configurable monitor system with up to 8 freely definable elements
- RFID reader/writer transponder with USB 2.0 interface designed for button area installations of C6 AMM systems
- Simple installation and wiring thanks to innovative hardware concept
- Integrated extension module for graphics and touch with just one cable up to 100 m
- Supports various makes of mounting arm mechanisms

C6 AMM ARM MOUNTING MONITOR

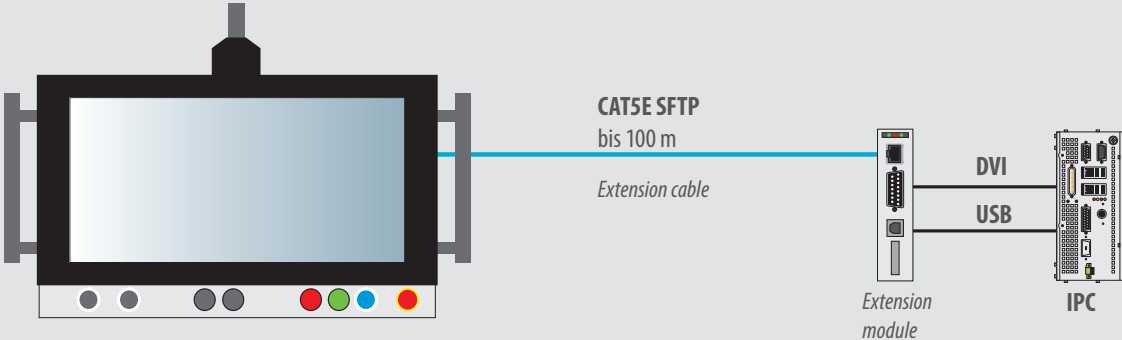
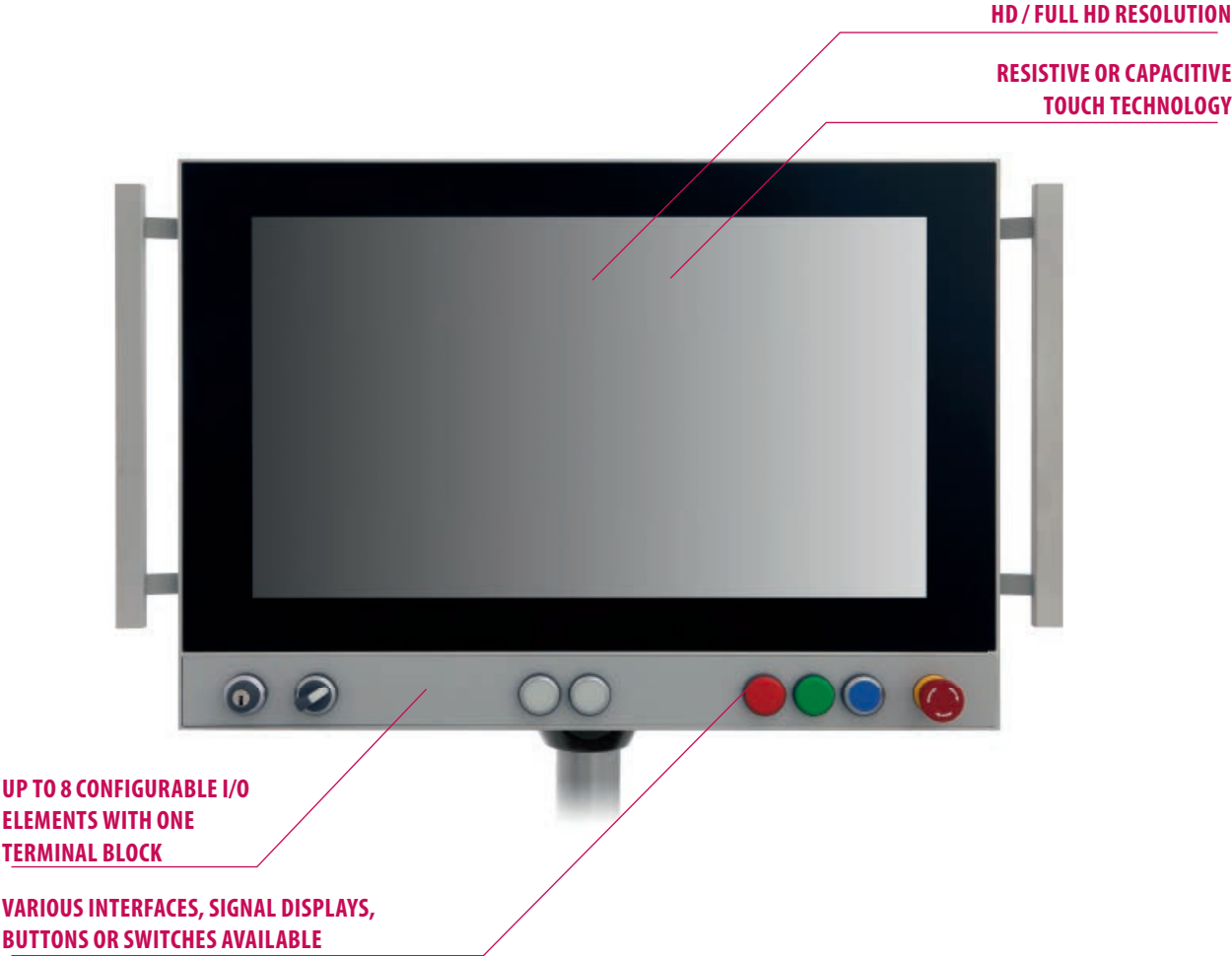

OPERATING DATA

Power supply	18 ... 32 V DC (isolated power supply)
Operating environment	0 ... 50 °C, Rel. humidity 80 % (without condensation)
Storage conditions	-20 ... 60 °C, Rel. humidity 80 % (without condensation)

APPROVALS

CE (EN 55022, EN 61000-3-2/3, EN 55024, EN 60950-1)

PANEL

Display size	15.6"W	18.5"W	21.5"W	15.6"W	18.5"W	21.5"W	24"W
Format	16:9	16:9	16:9	16:9	16:9	16:9	16:9
Resolution	1366 x 768	1366 x 768	1920 x 1080	1366 x 768	1366 x 768	1920 x 1080	1920 x 1080
Colours	16 M	16 M	16 M	16 M	16 M	16 M	16 M
Brightness	400 cd/m ²	300 cd/m ²	300 cd/m ²	400 cd/m ²	300 cd/m ²	300 cd/m ²	300 cd/m ²
Viewing angle (L:R/O:U)	160°, 160°	150°, 140°	178°, 178°	160°, 160°	150°, 140°	178°, 178°	178°, 178°
Touch technology	Resistive 5-wire			capacitive 4 finger			
Protection class	Full IP65			Full IP65			
Front panel	Aluminium			Aluminium, glass			
Installation	Arm mounting bottom or top (straight elements, no oblique elements)						
Mechanical adapter	RITTAL (CPS) / ROLEC (TARAPLUS) / HASEKE (ULT COUPLING 48)						

**FULLY ENCLOSED HOUSING
IN IP65**



REAR USB ACCESS

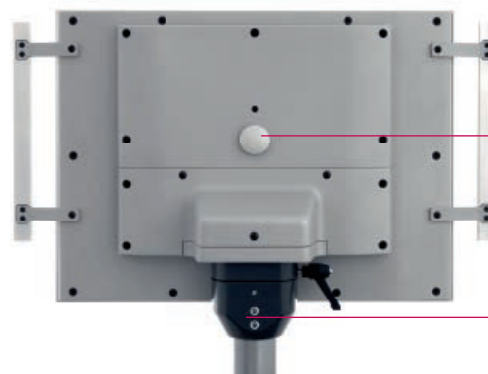

**VARIOUS ADAPTERS
AVAILABLE**

C6 AMM ARM MOUNTING MONITOR

DVI

DC POWER SUPPLY

DVI AND VGA

2 X USB (TYPE A)

1 X USB (TYPE B)

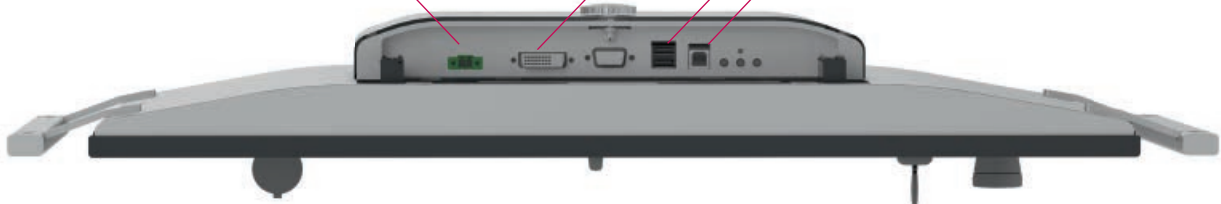

RVL

RJ45 (EXTENDER INPUT)

2 X USB (TYPE A)



INTERFACES
DVI
RVL

USB on back	2 x USB 2.0 (Type A) + 1 x USB 2.0 (Type B)	2 x USB 2.0 (Type A)
Standard Version up to 10 m Monitor input	1 x DVI-I and 1x VGA	-
Extended Version up to 100 m Extender input	-	1 x RJ45 (Extender input)

LCD TFT
A
B
C
D
E
F

15.6"W	433	320	240	13.5	30	54
18.5"W	503	358	276	14.5	36	91.5
21.5"W	582	403	314	18	40	134
24"W	640	439	347	19.4	40	175

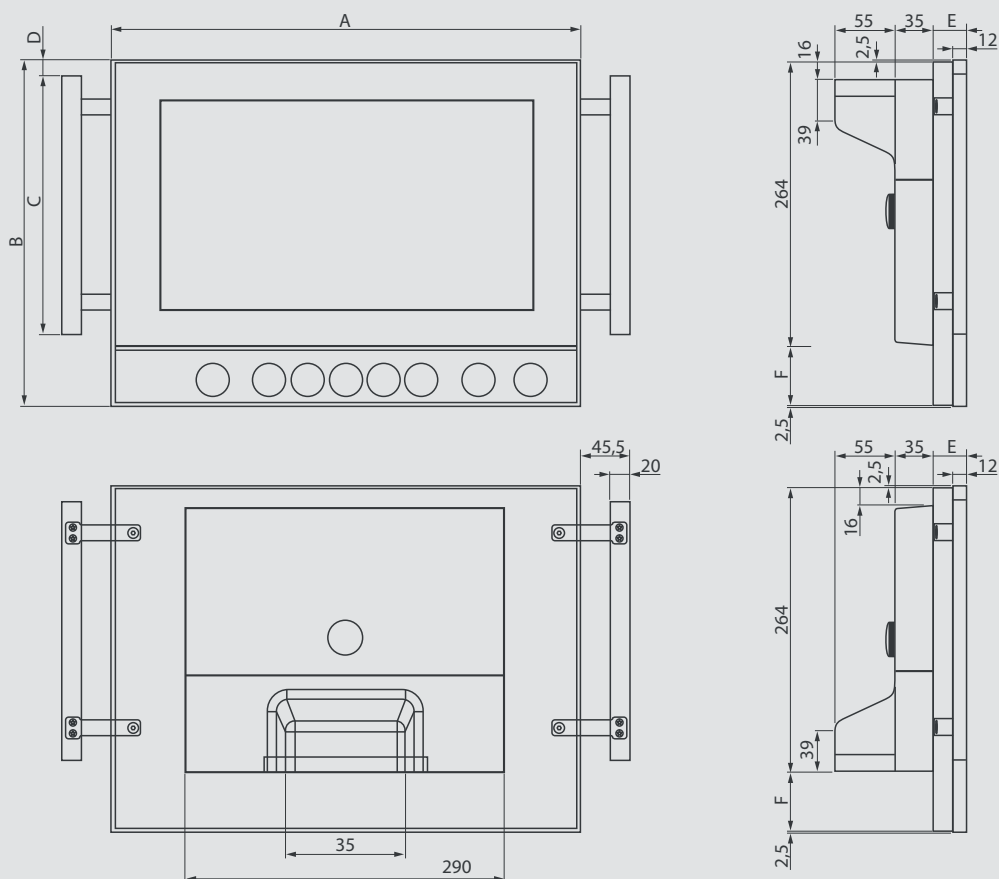



KEB



ETHERCAT FIELDBUS I/O

Analog or digital – the reception and emission of signals on the periphery of a plant requires decentralisation of the connection technology and a suitable medium for signal transmission to the central intelligence.

The C6 I/O System is based on the economically optimum Ethernet-based hardware and, thanks to the EtherCAT® protocol standard, brings the

proven properties of real-time communication to every single element of the input/output level. Just 25 mm wide, the plug-in system has a high packing density of up to 32 digital inputs and outputs.

- **C6 I/O**
- **C6 SAFETY I/O**

C6 REMOTE I/O

RELEASE LEVER

LABELLING CLIP

ETHERCAT BUS COUPLER

STATUS LEDS

TOP-HAT RAIL
FIXING AND
FUNCTION EARTH

SHIELDED CONNECTION
TO HOUSING CARRIER

SIGNAL STATUS
LEDS

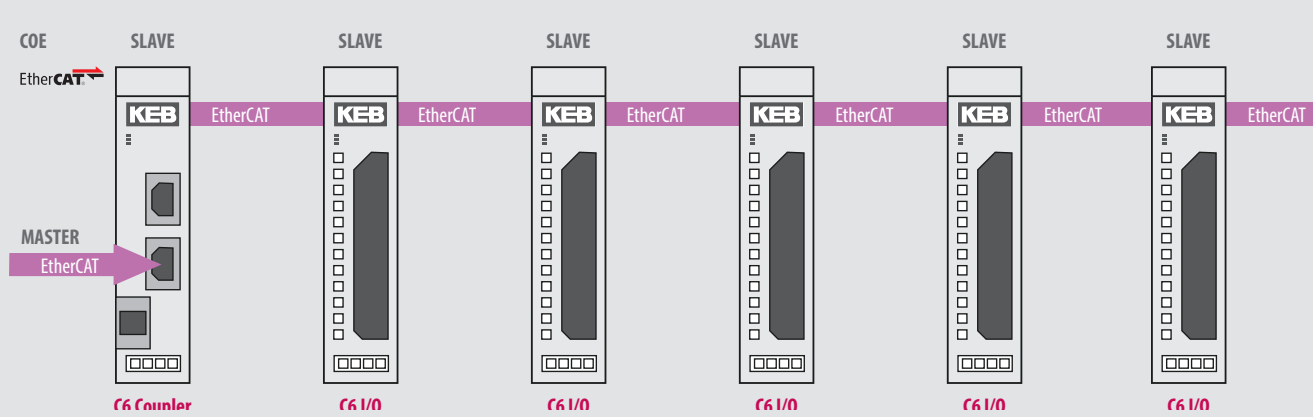
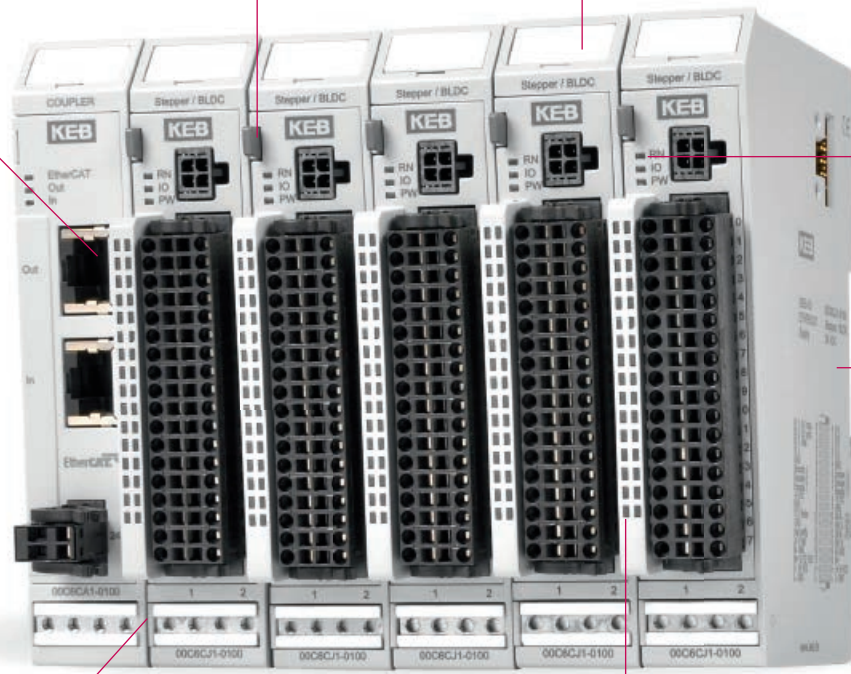



HIGHLIGHTS

- Complete EtherCAT® I/O system in real time
- Compact construction (32DI on 25 mm)
- Great range of modules
- Plug-in terminals and modules

C6 I/O

Fieldbus	EtherCAT® 100 Mbits/s
W x H x D	25 x 120 x 90 mm
Installation	35 mm DIN top-hat rail
Controller	ET 1100
E-Bus connection	10-in system plug in side wall
End module	not necessary
Power supply	24 V DC -20 % +25 %
Potential separation	Modules to each other and to bus
Operating temperature	0 ... +55 °C
Storage temperature	-25 ... +70 °C
Relative humidity	5 ... 95 %, without condensation
Protection class	IP20
Resistance to interference	Zone B to EN 61131-2

SHIELDED CONNECTION TERMINAL

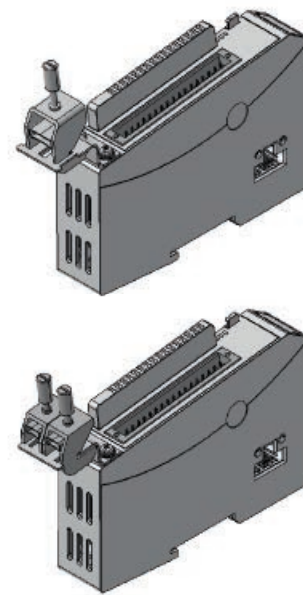

C6 REMOTE I/O ETHERCAT BUSMODULES

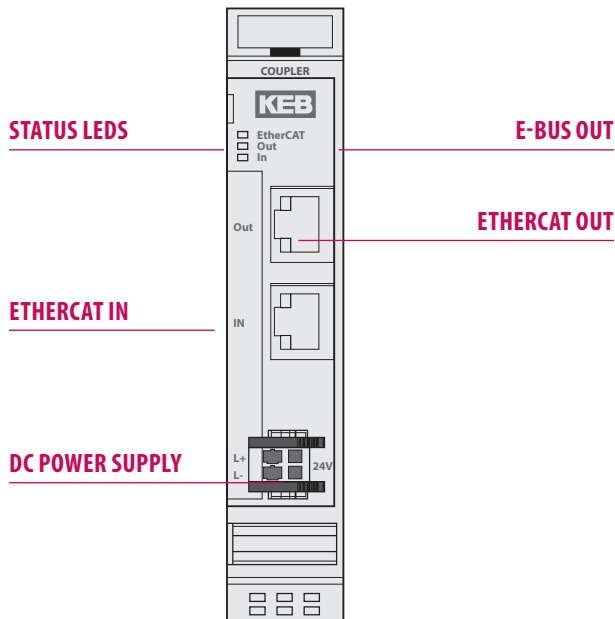

BUS MODULE	COUPLER
Fieldbus	EtherCAT® 100 Mbits/s
Power supply	24 V DC -20 % +25 %
Potential separation	Modules to each other and to bus
Operating temperature	0 ... +55 °C
Storage temperature	-25 ... +70 °C
Relative humidity	5 ... 95 %, without condensation
E-Bus supply	max. 3 A (approx. 20 modules)

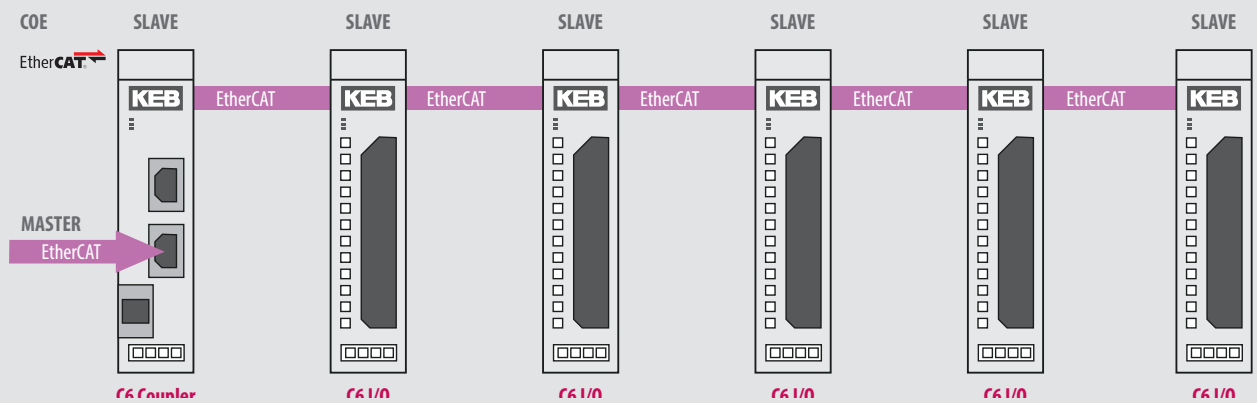

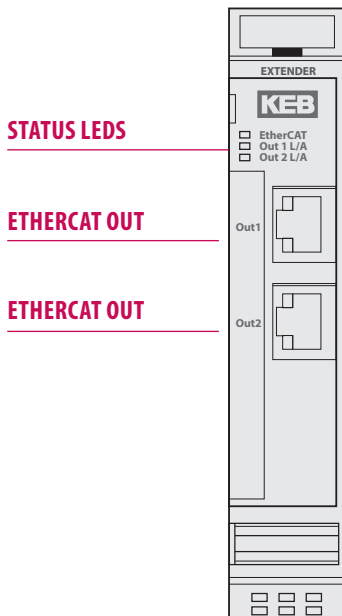

BUS MODULE	EXTENDER
Fieldbus	2x EtherCAT® 100 Mbits/s
Power supply	Via E-Bus
Potential separation	Modules to each other against bus
Operating temperature	0 ... +55 °C
Storage temperature	-25 ... +70 °C
Relative humidity	5 ... 95 %, without condensation
E-Bus load	160 mA for OUT1 210 mA for OUT1 + OUT2

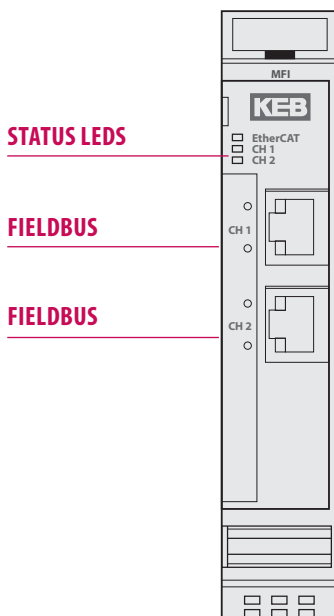

BUS MODULE	MULTI FIELDBUS INTERFACE
Fieldbus	Profinet Slave Ethernet IP Slave EtherCAT® Slave Powerlink Slave
Power supply	Via E-Bus
Potential separation	Modules to each other against bus
Operating temperature	0 ... +55 °C
Storage temperature	-25 ... +70 °C
Relative humidity	5 ... 95 %, without condensation
E-Bus load	240 mA

C6 REMOTE I/O ETHERCAT BUSMODULES +I/O

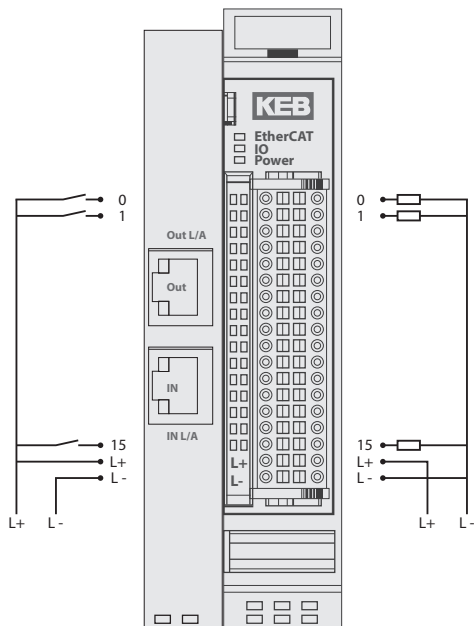

BUS MODUL

COUPLER + DI16 / DO16

Fieldbus	EtherCAT® 100 Mbits/s
Power supply	24 V DC -20 % +25 %
Potential separation	Modules to each other and to bus
Operating temperature	0 ... +55 °C
Storage temperature	-25 ... +70 °C
Relative humidity	5 ... 95 %, without condensation
E-Bus supply	max. 2 A (approx. 11 modules)
Digital inputs	16
Input delay	3 ms
Signal level (EN 61131-3, Type 1)	Off -3...5 V On 15...30 V
Digital outputs	16
Max. current	0.5 A per output
Total current	max. 8 A
E-Bus load	135 mA

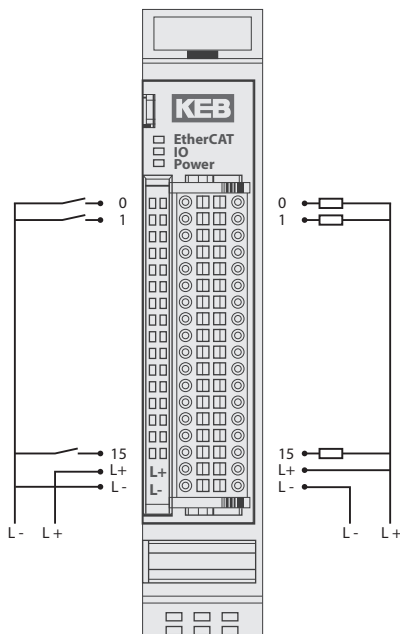

DI16 / DO16 LS

Digital inputs	16
Input delay	1 ms
Signal level (EN 61131-3, Type 1)	Off 15...30 V On -3...5 V
Digital outputs	16
Max. current	0.5 A per output
Total current	max. 8 A
E-Bus load	135 mA

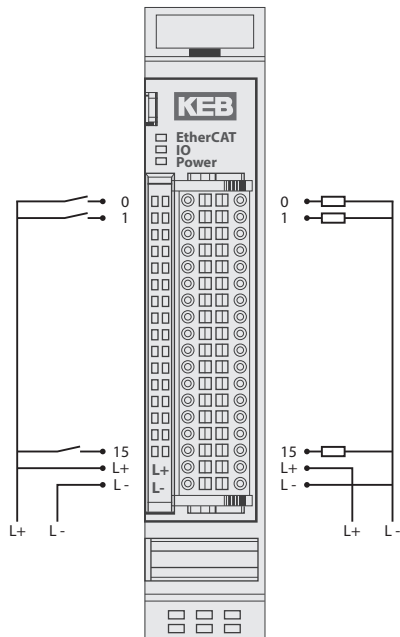

DI16 / DO16

Digital inputs	16
Input delay	1 ms
Signal level (EN 61131-3, Type 1)	Off -3...5 V On 15...30 V
Digital outputs	16
Max. current	0.5 A per output
Total current	max. 8 A
E-Bus load	135 mA

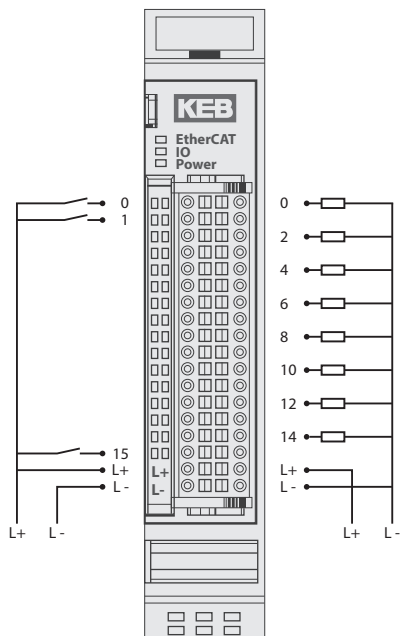

DI16/DO8 1A

Digital inputs	16
Input delay	1 ms
Signal level (EN 61131-3, Type 1)	Off -3...5 V On 15...30 V
Digital outputs	8
Max. current	1 A per output
Total current	max. 8 A
E-Bus load	135 mA

C6 REMOTE I/O ETHERCAT DIGITAL INPUTS

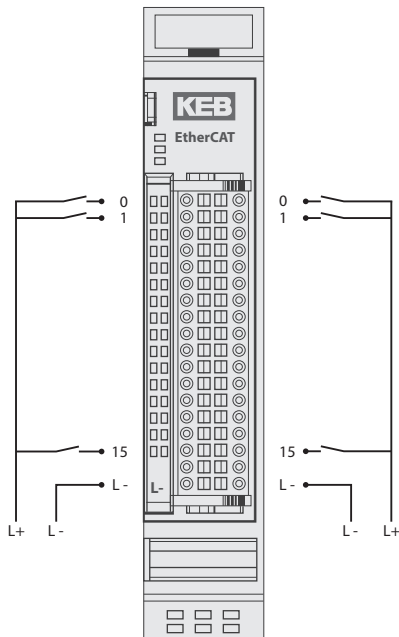

DI32

Digital inputs	32
Input delay	1 ms
Signal level (EN 61131-3, Type 1)	Off -3...5 V On 15...30 V
Digital outputs	-
Max. current	-
Total current	-
E-Bus load	85 mA

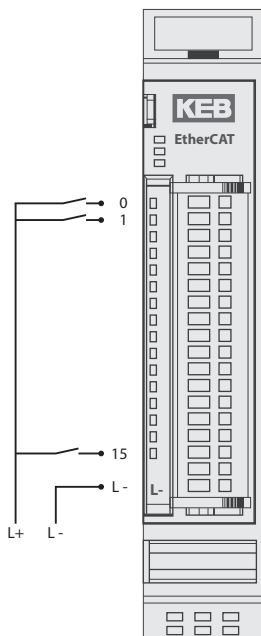

DI16

Digital inputs	16
Input delay	1 ms
Signal level (EN 61131-3, Type 1)	Off -3...5 V On 15...30 V
Digital outputs	-
Max. current	-
Total current	-
E-Bus load	100 mA

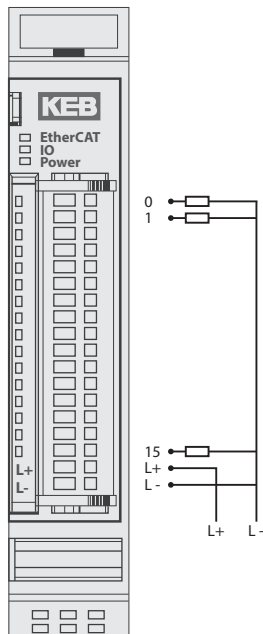

D016 0,5A

Digital inputs	-
Input delay	-
Signal level (EN 61131-3, Type 1)	-
Digital outputs	16
Max. current	0.5 A per output
Total current	max. 8 A
E-Bus load	130 mA

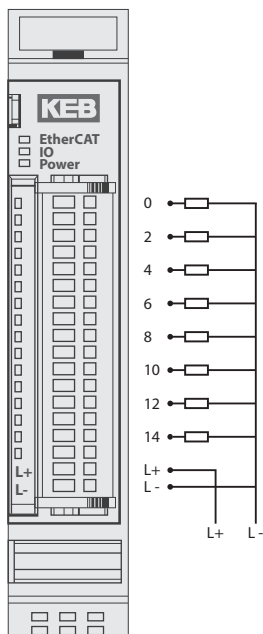

D08 1A

Digital inputs	-
Input delay	-
Signal level (EN 61131-3, Type 1)	-
Digital outputs	8
Max. current	1 A per output
Total current	max. 8 A
E-Bus load	130 mA

D08 2A

Digital inputs	-
Input delay	-
Signal level (EN 61131-3, Type 1)	-
Digital outputs	8
Max. current	2 A per output
Total current	max. 10 A
E-Bus load	130 mA

C6 REMOTE I/O ETHERCAT RELAY OUTPUTS

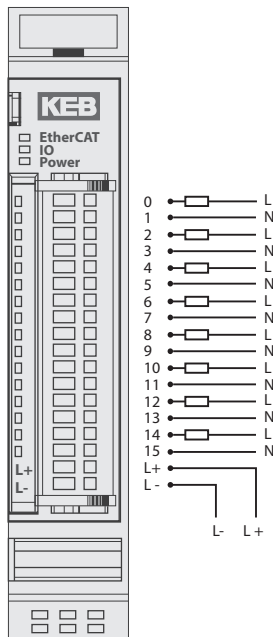

D08 RELAY NO 230 V

Digital inputs	-
Input delay	-
Signal level (EN 61131-3, Type 1)	-
Digital outputs	8
Max. current	5 A (resistive) / 2 A (inductiv)
Switching voltage	max. 24 V DC / 230 V AC
Switching cycles mech. (min.)	2×10^7
Switching cycles elec. (min.)	3×10^5 (2 A / 30 V DC)
E-Bus load	130 mA

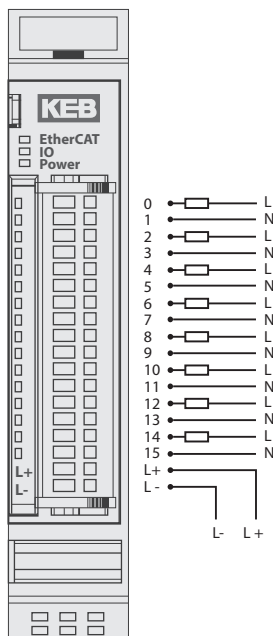

D08 RELAY NO 24 V

Digital inputs	-
Input delay	-
Signal level (EN 61131-3, Type 1)	-
Digital outputs	8
Max. current	5 A (resistive) / 2 A (inductiv)
Switching voltage	max. 24 V DC / 24 V AC
Switching cycles mech. (min.)	2×10^7
Switching cycles elec. (min.)	3×10^5 (2 A / 30 V DC)
E-Bus load	130 mA

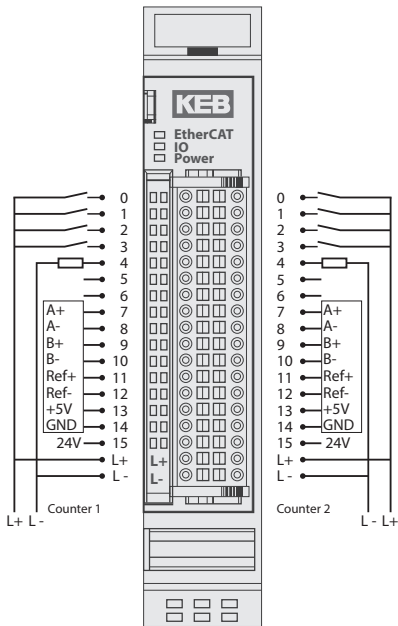

DOUBLE COUNTER

Encoder	2 A, B, Ref
Encoder type	5 V (RS422)
Count frequency	max. 200 kHz
Digital inputs	8
Input delay	1ms
Signal level (EN 61131-3, Type 1)	Off -3...5 V On 15...30 V
Digital outputs	2
Max. current	2 A per output
Analog outputs	-
Resolution	-
E-Bus load	300 mA

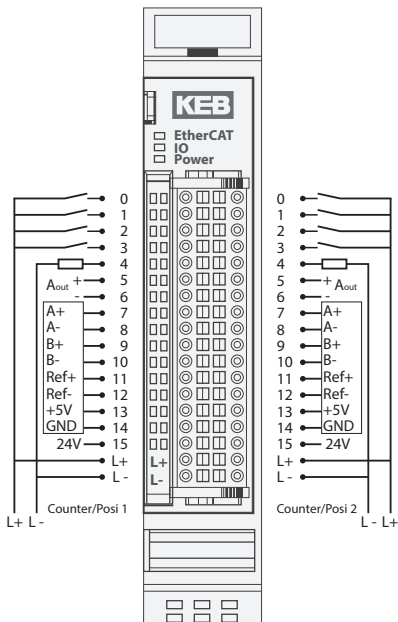

DOUBLE COUNTER/POSI

Encoder	2 A, B, Ref
Encoder type	5 V (RS422)
Count frequency	max. 200 kHz
Digital inputs	8
Input delay	1ms
Signal level (EN 61131-3, Type 1)	Off -3...5 V On 15...30 V
Digital outputs	2
Max. current	2 A per output
Analog outputs	2
Resolution	12 BIT
E-Bus load	300 mA

C6 REMOTE I/O ETHERCAT MIX | DRIVE

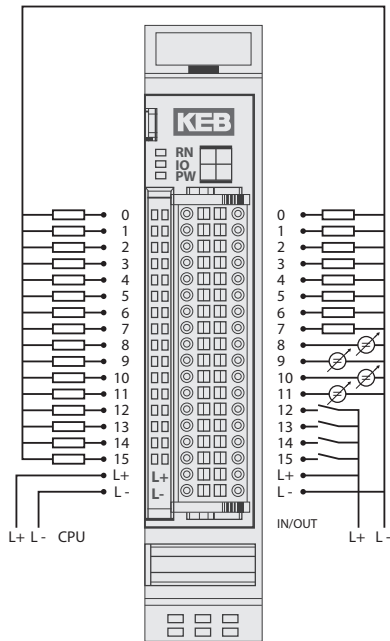

MIX02

Digital inputs	4 (8)
DI0..3	1ms
DI4	0.1ms
DI5..7	0.001ms
Counter (DI5)	500kHz (up to 1 MHz)
Digital outputs	24
D00..7:	0.5A
D08..23:	0.1A
Analog inputs 12 Bit	4 x 0..10V (also usable as DI, DI0..3)
Sampling rate	1ms
RS485	potential-separated
Baud rate	2.4...921.6 kBit/s
E-Bus load	90 mA

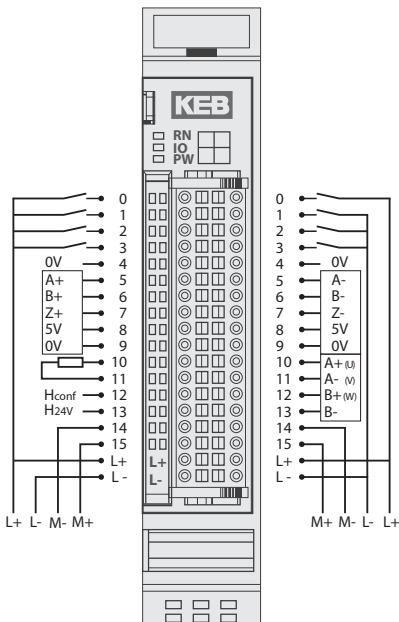

DRIVE MODULE

Motor connection	2-phase stepper motor or brushless DC motor
Motor voltage	12 V .. 72 VDC / cULus: 12 V .. 42 VDC
Motor current nominal	5 A
Peak current	Stepper motor: 10 A / brushless DC Motor: 15 A
Incremental emitter	5 V / 24 V (A, /A, B, /B, Z, /Z)
Hall emitter	5 V / 24 V (H1, H2, H3) or 3 extra zero-switching digital inputs
Digital inputs	5 x 1 ms configurable, e.g. reference switch, limit switch, release
Digital outputs	1 x 0.5 A (brake output or standard output)
Control	CIA402
E-Bus load	100 mA

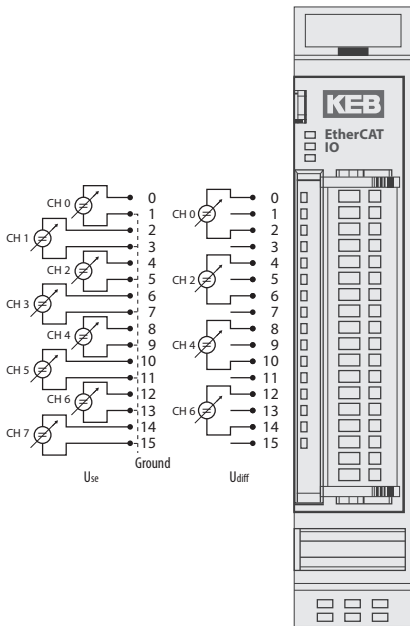

AI4/8-U (CoE)

Analog inputs	8 single-ended or 4 differential
Resolution	13 Bit (1.221 μ V unipolar/ 2.422 μ V bipolar)
Measurement range	0...10 V, \pm 10 V
Conversion time	464 μ s (if all channels are active)
Output rate	-
E-Bus load	190 mA

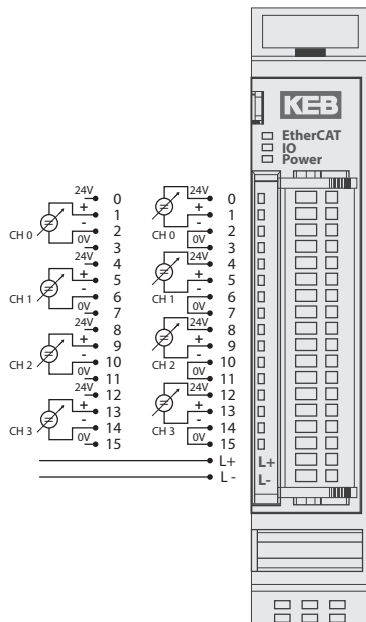

AI4-I (CoE)

Analog inputs	4
Resolution	12 Bit (5.2 μ A)
Measurement range	0...20 mA, 4...20 mA (end value 20 mA)
Conversion time	235 μ s (if all channels are active)
Output rate	-
E-Bus load	190 mA

C6 REMOTE I/O ETHERCAT ANALOG INPUTS

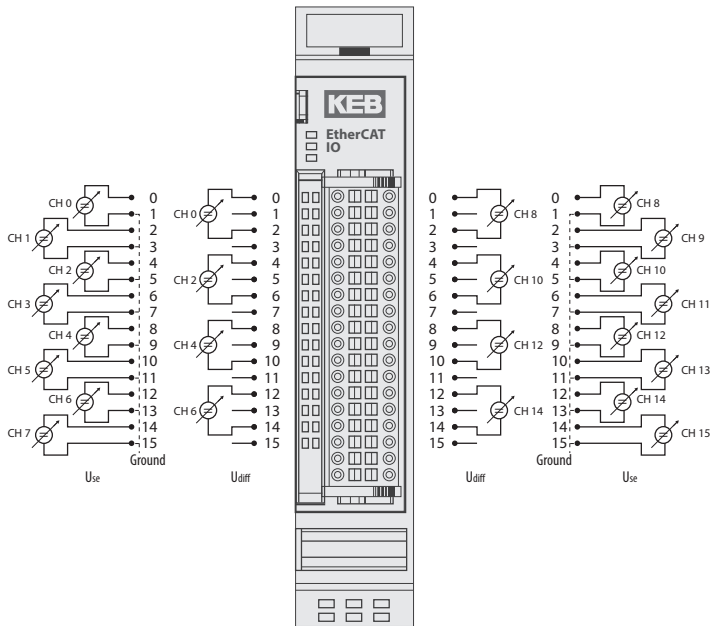

AI8/16-U (CoE)

Analog inputs	16 single-ended or 8 differential
Resolution	13 Bit (1,221 μ V unipolar/ 2,422 μ V bipolar)
Measurement range	0...10 V, \pm 10 V
Conversion time	580 μ s (if all channels are active)
Output rate	-
E-Bus load	190 mA

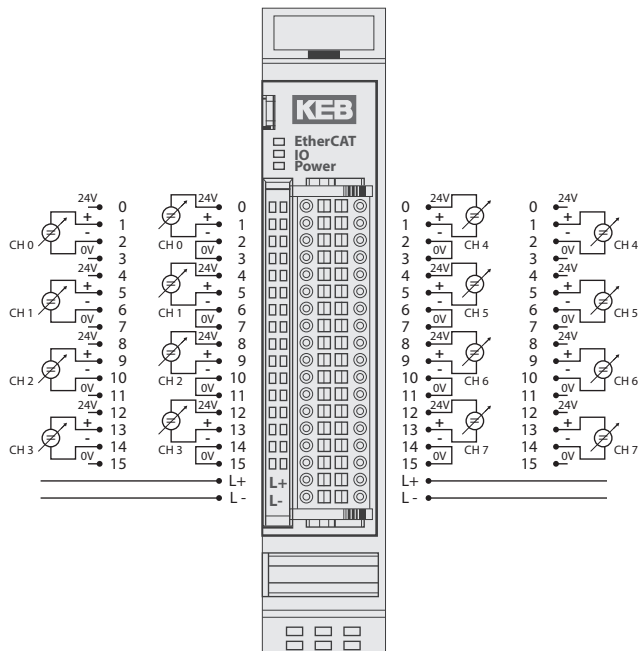

AI8-I (CoE)

Analog inputs	8
Resolution	12 Bit (5.2 μ A)
Measurement range	0...20 mA, 4...20 mA (end value 20 mA)
Conversion Time	290 μ s (if all channels are active)
Output rate	-
E-Bus load	190 mA

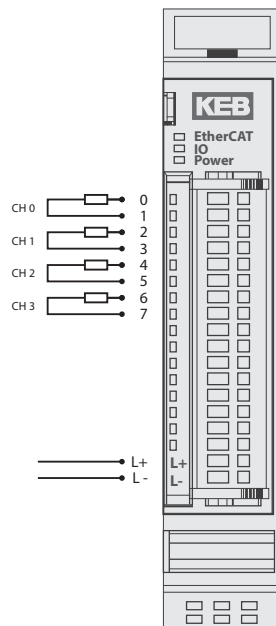

A04-U/I (CoE)

Analog outputs	4
Resolution	16 Bit
Measurement range	0...10 V, ± 10 V, 0...20 mA
Output rate	220 ms
E-Bus load	150 mA

C6 REMOTE I/O ETHERCAT TEMPERATURE INPUTS

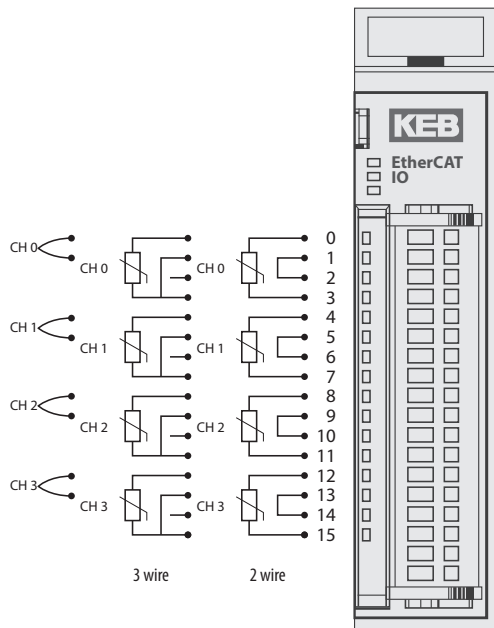

AI4-PT/NI/ THERMO

Analog inputs	4
Resolution	16 Bit
Conversion time	50ms (adjustable)
E-Bus load	170 mA

Thermoelement

Sensor types	J,K, mV (internal)
Cold point compensation	yes
Measuring range Typ K	-200 °C...+1372 °C
Measuring range Typ J	-50 °C...+760 °C
Measuring range mV	-40 ... +65 mV

Pt100 / Ni100

Measuring range Pt	-75 °C...+670 °C
Measuring range Ni	-60 °C...+250 °C
Input resistance	70...320 Ω
Measuring current	1 mA (typical)

Pt1000 / Ni1000

Measuring range Pt	-75 °C...+670 °C
Measuring range Ni	-60 °C...+250 °C
Input resistance	700...3200 Ω
Measuring current	0.1 mA (typical)

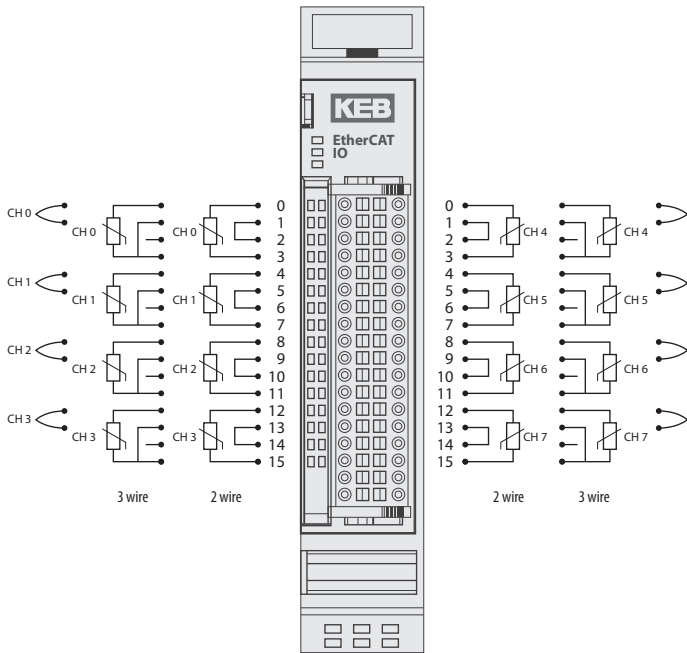

A18-PT/NI/THERMO

Analog inputs	8
Resolution	16 Bit
Conversion time	50ms (adjustable)
E-Bus load	170 mA

Thermocouple

Sensor types	J,K, mV (internal)
Cold point compensation	yes
Measuring range Typ K	-200 °C...+1372 °C
Measuring range Typ J	-50 °C...+760 °C
Measuring range mV	-40 ... +65 mV

Pt100 / Ni100

Measuring range Pt	-75 °C...+670 °C
Measuring range Ni	-60 °C...+250 °C
Input resistance	70...320 Ω
Measuring current	1 mA (typical)

Pt1000 / Ni1000

Measuring range Pt	-75 °C...+670 °C
Measuring range Ni	-60 °C...+250 °C
Input resistance	700...3200 Ω
Measuring current	0.1 mA (typical)

C6 REMOTE I/O POTENTIAL DISTRIBUTOR

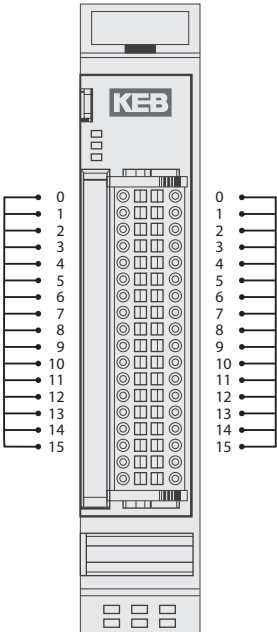

POTENTIAL DISTRIBUTOR

Connections	2x 16
	The module has 2 separate potential lines
E-Bus load	0 mA



KEB WORLDWIDE

Austria | KEB Automation GmbH
Ritzstraße 8 4614 Marchtrenk Austria
Tel: +43 7243 53586-0 Fax: +43 7243 53586-21
E-Mail: info@keb.at Internet: www.keb.at

Belgium | KEB Automation KG
Herenveld 2 9500 Geraardsbergen Belgium
Tel: +32 544 37860 Fax: +32 544 37898
E-Mail: vb.belgien@keb.de Internet: www.keb.de

Brazil | KEB South America – Regional Manager
Rua Dr. Omar Pacheco Souza Riberio, 70
BR-CEP 13569-430 Portal do Sol, São Carlos Brazil
Tel: +55 16 31161294 E-Mail: roberto.arias@keb.de

France | Société Française KEB SASU
Z.I. de la Croix St. Nicolas 14, rue Gustave Eiffel
94510 La Queue en Brie France
Tel: +33 149620101 Fax: +33 145767495
E-Mail: info@keb.fr Internet: www.keb.fr

Germany | Headquarters
KEB Automation KG
Suedstraße 38 32683 Barntrup Germany
Telefon +49 5263 401-0 Fax +49 5263 401-116
E-Mail: info@keb.de Internet: www.keb.de

Germany | Geared Motors
KEB Antriebstechnik GmbH
Wildbacher Straße 5 08289 Schneeberg Germany
Telefon +49 3772 67-0 Fax +49 3772 67-281
E-Mail: info@keb-drive.de Internet: www.keb-drive.de

Italy | KEB Italia S.r.l. Unipersonale
Via Newton, 2 20019 Settimo Milanese (Milano) Italia
Tel: +39 02 3353531 Fax: +39 02 33500790
E-Mail: info@keb.it Internet: www.keb.it

Japan | KEB Japan Ltd.
15 - 16, 2 - Chome, Takanawa Minato-ku
Tokyo 108 - 0074 Japan
Tel: +81 33 445-8515 Fax: +81 33 445-8215
E-Mail: info@keb.jp Internet: www.keb.jp

P. R. China | KEB Power Transmission Technology (Shanghai) Co. Ltd.
No. 435 QianPu Road Chedun Town Songjiang District
201611 Shanghai P. R. China
Tel: +86 21 37746688 Fax: +86 21 37746600
E-Mail: info@keb.cn Internet: www.keb.cn

Republic of Korea | KEB Automation KG
Room 1709, 415 Missy 2000 725 Su Seo Dong
Gangnam Gu 135- 757 Seoul Republic of Korea
Tel: +82 2 6253 6771 Fax: +82 2 6253 6770
E-Mail: vb.korea@keb.de Internet: www.keb.de

Russian Federation | KEB RUS Ltd.
Lesnaya str, house 30 Dzerzhinsky MO
140091 Moscow region Russian Federation
Tel: +7 495 6320217 Fax: +7 495 6320217
E-Mail: info@keb.ru Internet: www.keb.ru

Spain | KEB Automation KG
c / Mitjer, Nave 8 - Pol. Ind. LA MASIA
08798 Sant Cugat Sesgarrigues (Barcelona) Spain
Tel: +34 93 8970268 Fax: +34 93 8992035
E-Mail: vb.espana@keb.de Internet: www.keb.de

Switzerland | KEB Automation AG
Witzbergstraße 24 8330 Pfaeffikon/ZH Switzerland
Tel: +41 43 2886060 Fax: +41 43 2886088
E-Mail: info@keb.ch Internet: www.keb.ch

United Kingdom | KEB (UK) Ltd.
5 Morris Close Park Farm Industrial Estate
Wellingborough, Northants, NN8 6 XF United Kingdom
Tel: +44 1933 402220 Fax: +44 1933 400724
E-Mail: info@keb.co.uk Internet: www.keb.co.uk

United States | KEB America, Inc.
5100 Valley Industrial Blvd. South
Shakopee, MN 55379 United States
Tel: +1 952 2241400 Fax: +1 952 2241499
E-Mail: info@kebameric.com Internet: www.kebameric.com



KEB PARTNERS WORLDWIDE

... www.keb.de/contact/contact-worldwide

The KEB logo consists of the letters 'KEB' in a bold, white, sans-serif font, set against a dark red rectangular background. To the right of this rectangle is another solid dark red rectangle of the same height, creating a two-part header element.

KEB

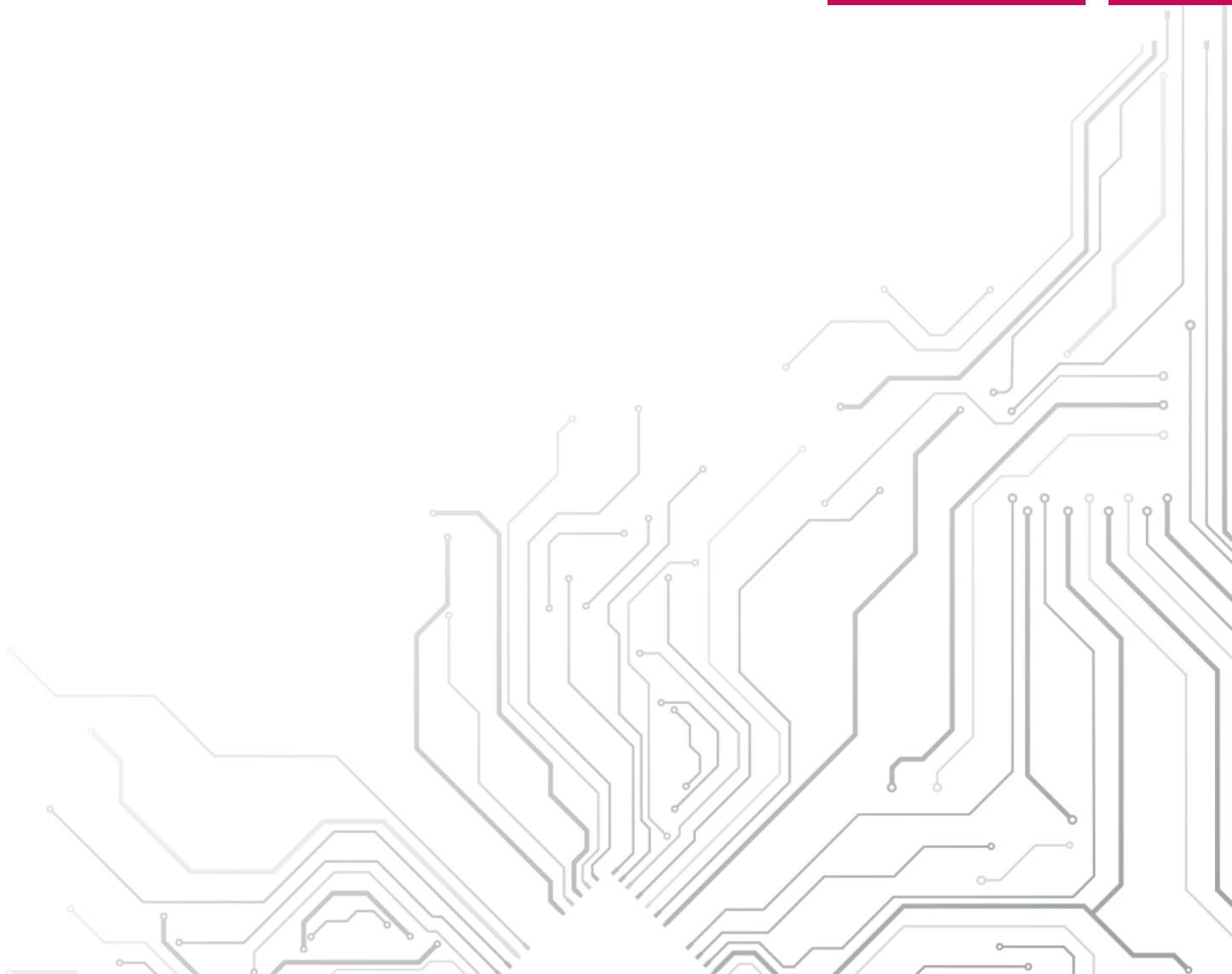

CONTROL AND AUTOMATION

Automation with Drive

www.keb.de

KEB Automation KG Südstrasse 38 32683 Bartrup Germany Tel. +49 5263 401-0 E-Mail: info@keb.de

© KEB 000000-51CA 11.2019 Subject to technical alterations!