

**KEB**

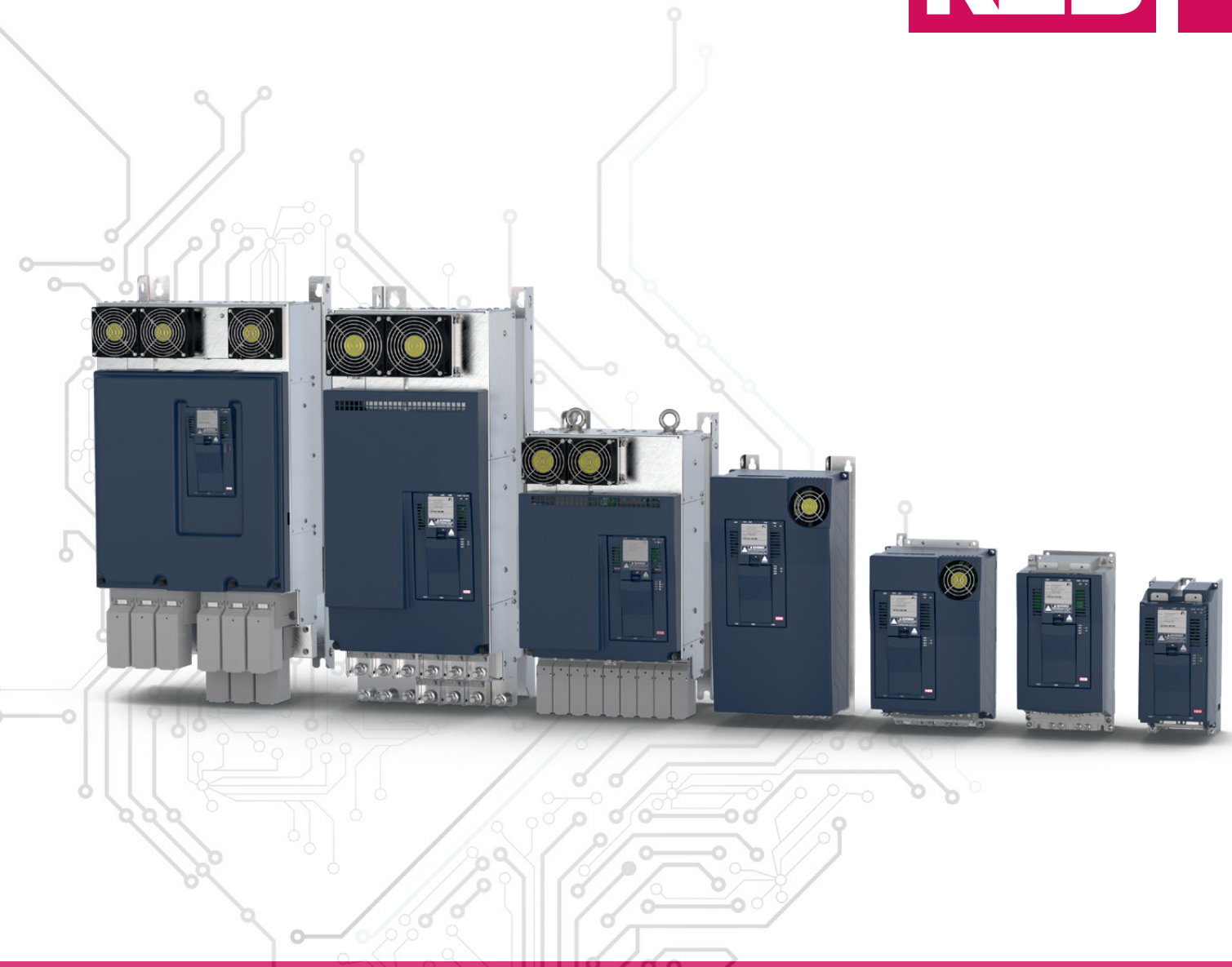

# COMBIVERT F6

DRIVE CONTROLLER 2.2 ... 450 kW

EN



<b>CONTENT</b>	<b>PAGE</b>
System overview	3
Benefits at a glance	4
COMBIVERT F6 Variants	6
Functional Safety	8
Technical data	10
COMBIVIS 6	12
Accessories	14
KEB worldwide	15

# SYSTEM OVERVIEW

## Automation with Drive

stands as a synonym for optimally selected combinations of control and automation solutions with the drive level at the end it is the key to successful machine concepts.

Let the following pages inspire you with regards to the diversity and performance of the COMBIVERT F6 drive controller, and help you to find a solution that reliably meets your requirements.

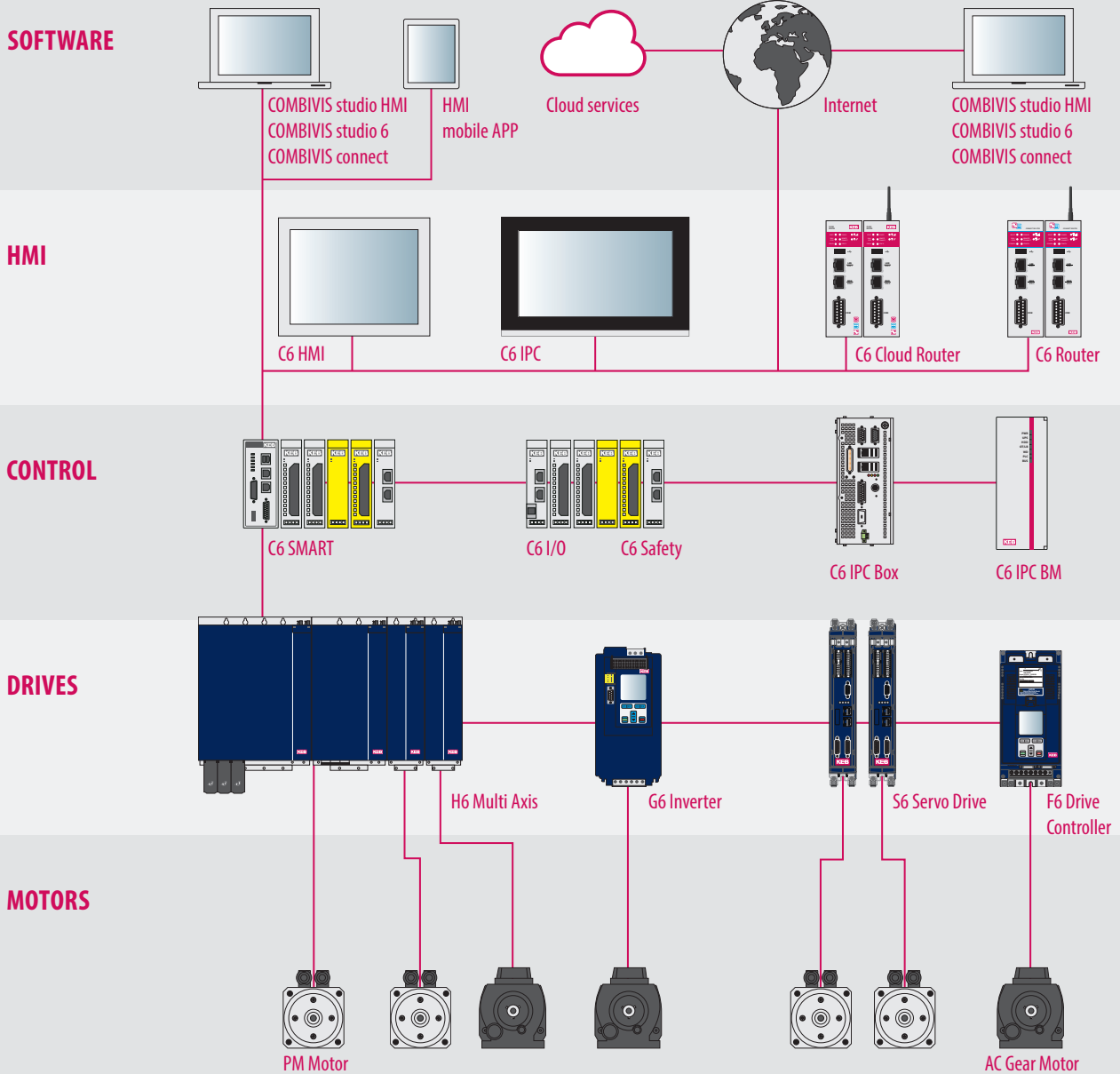

**OPTIMALLY SELECTED COMPONENTS**

Flexibility, functionality, efficiency and cost-effectiveness are the key requirements for today's drive system. The single axis drive controller COMBIVERT F6, in the power range from 2.2 to 450 kW is covering these requirements and is a perfect extension of the KEB drive portfolio.

The COMBIVERT F6 with its capability to operate different motor types, the various real-time communication to higher-level controllers, the choice of integrated Safety function modules or the cooling concept is the perfect drive controller for every machine. The intuitive PC tool COMBIVIS 6 makes the newly developed KEB drive platform easy to handle.

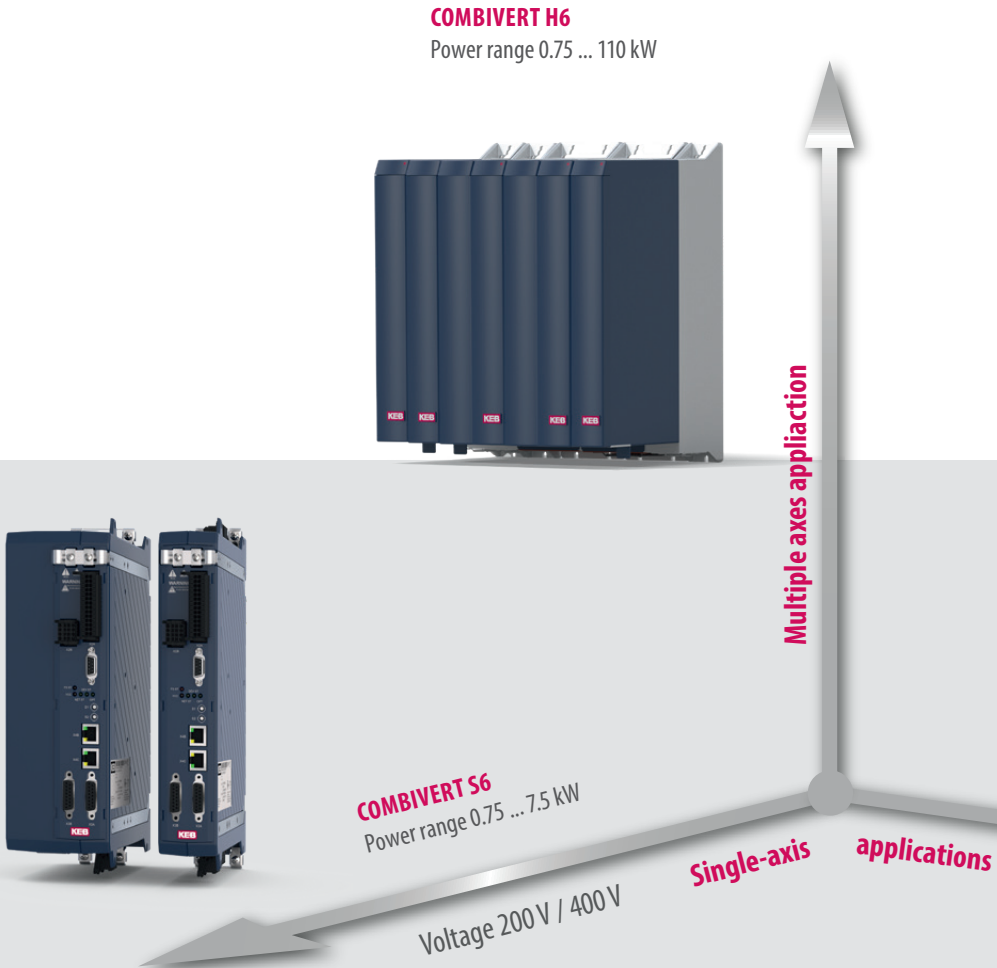

**DRIVE BASED SAFETY**

- Integrated Safety functionality
- Basic function STO in Compact variant
- Additional High Level Safety in Application variant
- Encoderless safety in variant PRO

**REAL - TIME COMMUNICATION**

or simply serially

- Real-time Ethernet-based interfaces
- CAN
- RS232/485 for diagnostics or display

**ALL IN ONE - UNIVERSAL MOTOR OPERATIONS**

- Control for synchronous, asynchronous, IPM or synchronous reluctance motors
- Motor operation with encoder feedback or encoderless ASCL/SCL for precise speed control
- Motor temperature monitoring with PTC, KTY or PT1000 sensors
- Two-channel multi-encoder interface
- Integrated GTR7 brake transistor
- Integrated brake control and brake supply

**ANALOG & DIGITAL I/O**

supports actual machine concepts with

- 8 digital and 2 analog inputs
- 2 digital and 1 relay output
- 1 analog output 0 ... 10 V

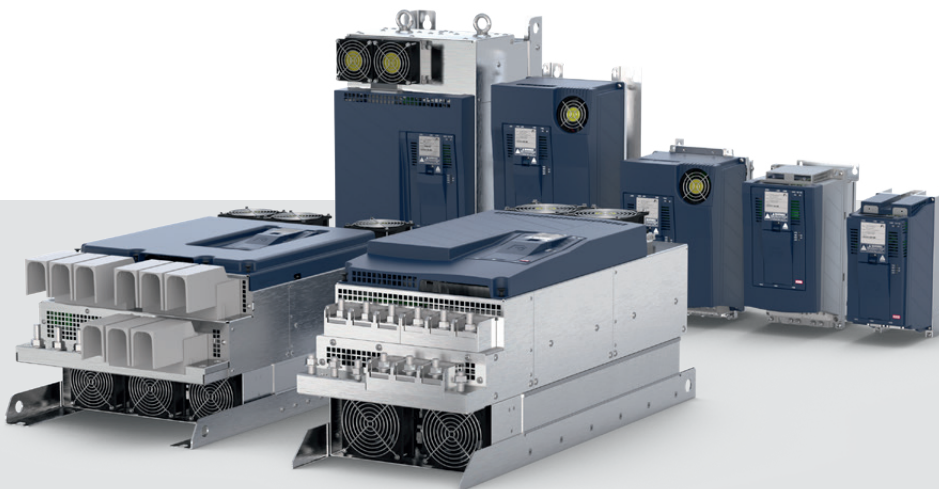

**COMBIVERT F6**  
Power range 2.2 ... 450 kW

Voltage 200 V / 400 V

**HIGHLIGHTS**

- Uncompromising integration, highest performance
- Modern realtime communication standards
- Integrated functional safety
- Particular compact size
- Modular design, flexible cooling systems

# COMBIVERT F6 - VARIANTS

## FUNCTIONAL SAFETY

### INTERFACES

CAN interface  
Realtime Ethernet

### LCD DISPLAY

LCD Operator  
Ethernet Operator  
USB Operator

### PTC/KTY/PT1000 EVALUATION

### BRAKE CONTROL 24 V / 2 A

### MAINS CONNECTIONS

### I/O

8 digital inputs  
2 digital outputs  
1 relay  
2 analog inputs  
1 analog output  
24V DC supply

### STATUS LEDS

### DIAGNOSTIC INTERFACE

### MULTI ENCODER INTERFACES

Resolver, EnDAT, HIPERFACE, BISS, SSI,  
Incremental HTL/TTL,  
Incremental output

### MOTOR TERMINALS

### DC SUPPLY TERMINALS

and braking resistor

EtherCAT®

Safety over  
EtherCAT®



CANopen®



## HIGHLIGHTS

- Universally usable for many motor technologies
- Highest performance in torque, speed and position control
- Uncompromising integration
- User-friendly
- Scalable safety functions...

**COMPACT**  
**HIGHLY INTEGRATED**  
**AND ECONOMICAL**

STO

**REALTIME ETHERNET**

**EtherCAT OR VARAN**

Communication interface

**CAN**  
**DIAGNOSTIC RS232/485**

**APPLICATION**  
**MODULAR AND FLEXIBLE**

STO, SBC and speed/position related safety functions

**REALTIME ETHERNET**

**EtherCAT**  
**PROFINET**  
**POWERLINK**  
**EtherNet/IP**

Communication interface

**CAN**  
**DIAGNOSTIC RS232/485**

**PRO**  
**ENCODERLESS SAFETY**

STO, SBC and speed related safety functions without encoder feedback

**REALTIME ETHERNET**

**EtherCAT**

Communication interface

**CAN**  
**DIAGNOSTIC RS232/485**  
**Ethernet**



**HIGHLIGHTS**

- Brake handling
- Power-off
- DC-brake
- PID controller
- Round table function
- Recipe management
- Multi motor handling
- Anti cogging
- Liquide cooling management
- Etc.

# SAFETY FUNCTIONS IN THE DRIVE

## BASIS FOR SAFETY

### COMPACT

In the Compact variant, the COMBIVERT F6 and S6 drive controllers are equipped with Safe-Torque-Off (STO).

## SAFETY FUNCTIONS WITH SPEED AND POSITION MONITORING

### APPLICATION

The device variant Application is available in two versions. In addition to STO, Module 1 adds safe brake control (SBC) which provides a safe 24 V supply for the brakes.

Module 3 offers safe motion functionality according to IEC 61800-5-2 through speed and position detection using encoders.

The error reaction time is shortened and costs are reduced by reducing the number of separate protective devices. Module 3 also offers the option of controlling all available safety functions and limit values via Safety over EtherCAT (FSoE).

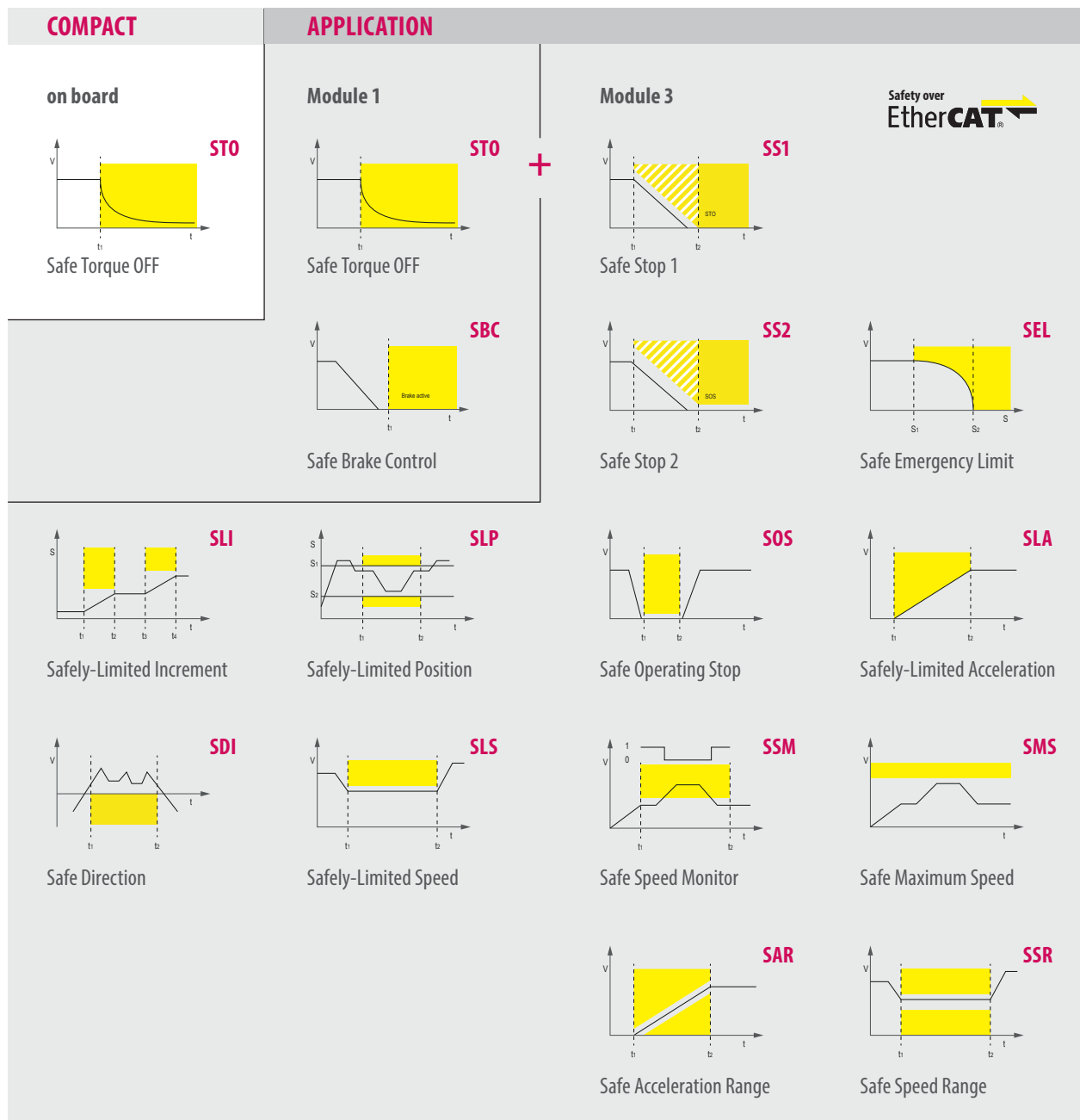



## ENCODERLESS SAFETY FUNCTIONS

### PRO

The Pro device variant of the COMBIVERT F6 and S6 drive controllers offers advanced safety functions without having to use a safety encoder. The device determines the safe velocity parameters from the pulse width modulation (PWM) of the motor supply.

In addition to STO, Module 5 is equipped with a safe brake control (SBC), which provides a safe 24 V supply for braking operation as well as a monitoring of the switching status of the brake via microswitch evaluation.

Module 5 also offers the option of controlling all available safety functions via Safety over EtherCAT (FSoE).

**PRO**

**Module 5**

**STO**

Safe Torque OFF

**SLS**

Safely-Limited Speed

**SS1**

Safe Stop 1

**SLA**

Safely-Limited Acceleration

**SMS**

Safe Maximum Speed

**SBC**

Safe Brake Control

**SSM**

Safe Speed Monitor

**SDLC**

Safe Door-Lock Control

Safety over  
**EtherCAT**



### WHY USE DRIVE-BASED SAFETY (SAFE MOTION)?

- Less wiring – remove contactors and other traditional safety components
- Fast reaction – direct handling inside the drive
- Easy to operate – up to 8 different safety setups per function
- Cost savings compared to traditional safety solution

# COMBIVERT F6 230 V

## TECHNICAL DATA

HOUSING		F6-2				F6-3			F6-4
		10	12	13	14	15	16	17	18
Device size									
Rated output power	[kVA]	4.4	7	9.6	13	19	25	30	34
Typical rated motor power	[kW]	2.2	4	5.5	7.5	11	15	18.5	22
Rated output current 230 V	[A]	11	17.5	24	33	48	60	75	85
Rated output current 240 V (UL)	[A]	11	17.5	24	33	48	60	75	85
Short-term current limit (60 s / max.)	[%]	150 / 216		150 / 180		150 / 216			150 / 180
Rated input current 230 V	[A]	16.5	22	30	41.5	on request			101
Rated input current 240 V (UL)	[A]	16.5	22	30	41.5	on request			101
Rated switching frequency	[kHz]	8	4	4	4	2	4	2	4
Max. switching frequency	[kHz]	16							
Mains phases		3							
Rated input voltage (AC)	[V]	230 (UL: 240)							
Input voltage range (AC)	[V]	170 ... 264							
Input voltage range (DC)	[V]	240 ... 373							
Mains frequency	[Hz]	50 / 60 ±2							
Output voltage	[V]	3 x 0 ... U <sub>IN</sub>							
Output frequency	[Hz]	0 ... 599 (optional 0 ... 2,000)*							

\* The maximum possible output frequency depends on the switching frequency

## THROUGH MOUNT VERSION

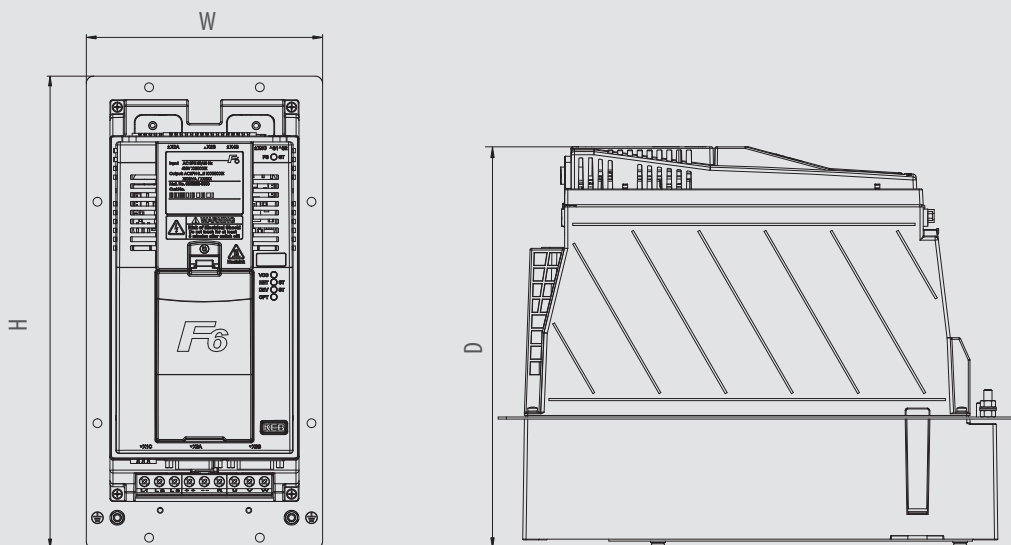

# COMBIVERT F6 400 V

HOUSING	Device size	F6-2					F6-3				F6-4				
		12	13	14	15	16	17	18	19	20	19	20	21	22	
	Rated output power	[kVA]	6.6	8.3	11.4	16.6	22.9	29	35	42	52	42	52	62	76
	Typical rated motor power	[kW]	4	5.5	7.5	11	15	18.5	22	30	37	30	37	45	55
	Rated output current 400 V	[A]	9.5	12	16.5	24	33	42	50	60	75	60	75	90	110
	Rated output current 480 V (UL)	[A]	7.6	11	14	21	27	34	40	52	65	52	65	77	96
	Short-term current limit (60 s / max.)	[%]	150 / 216				150 / 180								
	Rated input current 400 V	[A]	13	17	21	31	43	55	59	66	82	66	82	99	121
	Rated input current 480 V (UL)	[A]	11	15	18	27	35	44	48	57	71	57	71	85	106
	Rated switching frequency	[kHz]	8	8	4	4	4	2	2	2/4	2	4	4	2	2
	Max. switching frequency	[kHz]	16												
	Mains phases		3												
	Rated input voltage (AC)	[V]	400 (UL: 480)												
	Input voltage range (AC)	[V]	280 ... 550												
	Input voltage range (DC)	[V]	390 ... 780												
	Mains frequency	[Hz]	50 / 60 ±2												
	Output voltage	[V]	3 x 0 ... U <sub>IN</sub>												
	Output frequency	[Hz]	0 ... 599 (optional 0 ... 2,000)*												

\* The maximum possible output frequency depends on the switching frequency

## MECHANICAL DIMENSIONS

HOUSING	H*** (mm)	W*** (mm)	D*** (mm)	AIR COOLING		LIQUID COOLING	
				in-built	through mount	in-built	through mount
2	290	130	240	X	X	-	-
3	340	170	261	X	X	-	-
4	375	224	272	X	X	X	X
6	525	249	272	X	X	X	X
7	570	336	360	X	X	X	X
8	860	336	360	X	X	X	X
9	960	503	360	X	X	X	X

\*\*\* air cooled in-built version

HOUSING		F6-6				F6-7				F6-8			F6-9			
		21	22	23	24	25	26	27	28	28	29	30	30	31	32	33**
Rated output power	[kVA]	62	80	104	125	145	173	208	256	256	319	395	395	436	492	554
Typical rated motor power	[kW]	45	55	75	90	110	132	160	200	200	250	315	315	355	400	450
Rated output current 400 V	[A]	90	115	158	189	210	250	300	370	370	460	570	570	630	710	800
Rated output current 480 V (UL)	[A]	85	106	128	162	180	210	260	325	302	414	477	477	515	590	719
Short-term current limit (60 s / max.)	[%]	150 / 180				125 / 150						150 / 180				
Rated input current 400 V	[A]	99	126	158	189	221	263	315	390	390	485	600	600	700	746	840
Rated input current 480 V (UL)	[A]	85	106	128	162	186	217	269	337	374	429	494	494	533	611	744
Rated switching frequency	[kHz]	8	4	2/4/8**	2	4	4	2	2	4	2	2	2	2	2	2
Max. switching frequency	[kHz]	16										4				
Mains phases		3														
Rated input voltage (AC)	[V]	400 (UL: 480)														
Input voltage range (AC)	[V]	280 ... 550														
Input voltage range (DC)	[V]	390 ... 780														
Mains frequency	[Hz]	50 / 60 +/- 2														
Output voltage	[V]	3 x 0 ... U <sub>IN</sub>														
Output frequency	[Hz]	0 ... 599 (optional 0 ... 2,000)*														

\* The maximum possible output frequency depends on the switching frequency

\*\* Liquid cooled only

**BUILT-IN VARIANT**

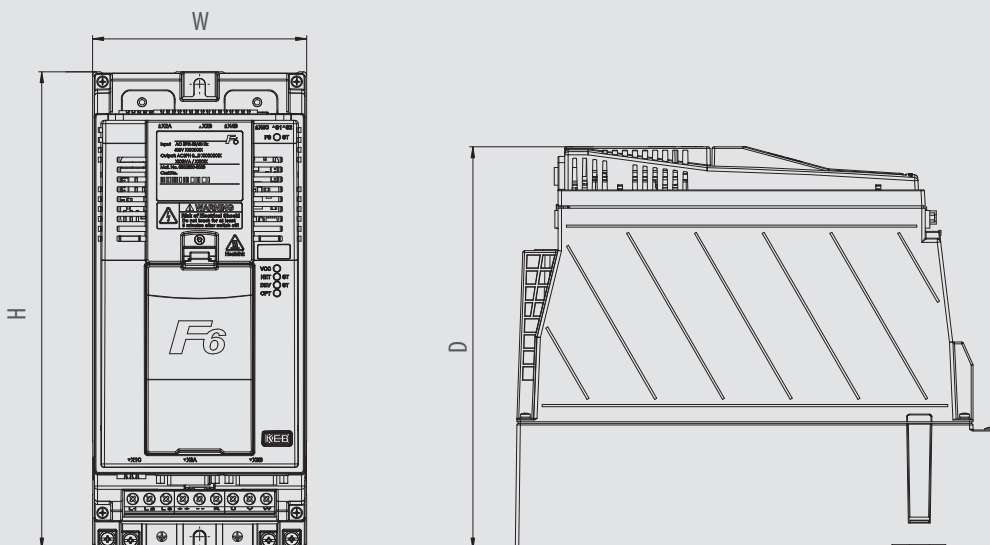

**Air-cooled built-in variant**

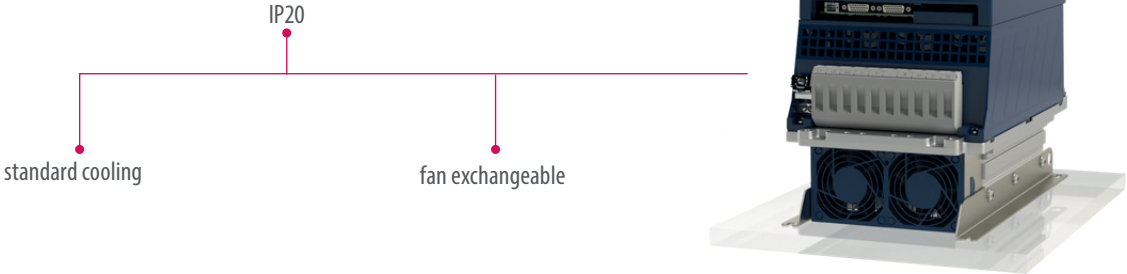

**Air-cooled push-through variant**

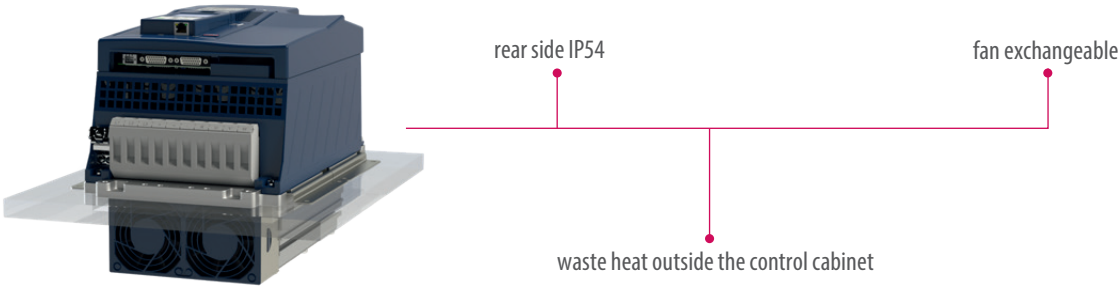

**Liquid-cooled built-in variant**

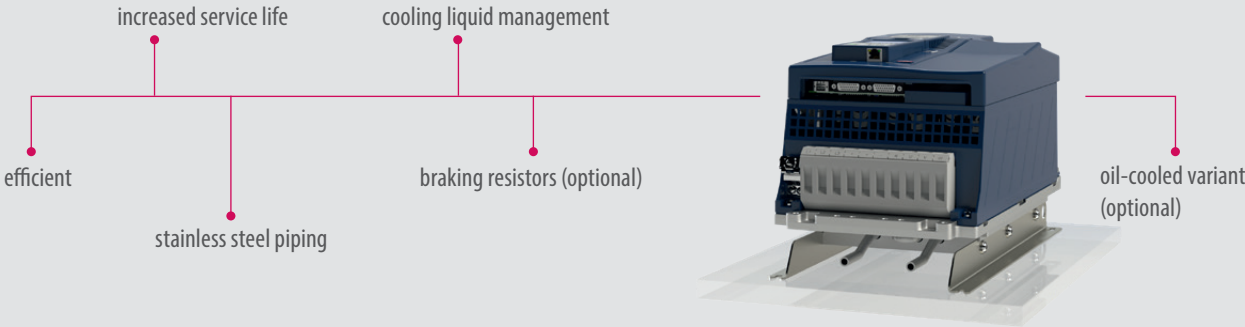

**Liquid-cooled push-through variant**

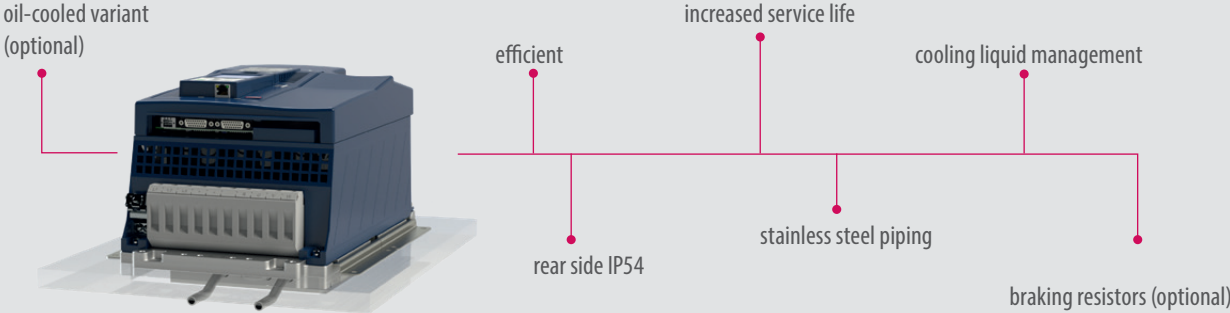

# COMBIVIS 6 - THE TOOL FOR ALL TASKS

## COMBIVIS 6

- Free and easy-to-use software for startup, administration and analysis
- Integrated start-up assistants (Wizards) for quick and easy configuration
- Direct access to device documentation
- 16 channel oscilloscope for extensive analysis
- Online parameter list comparison
- Parameterisation of key safety indicators and functions

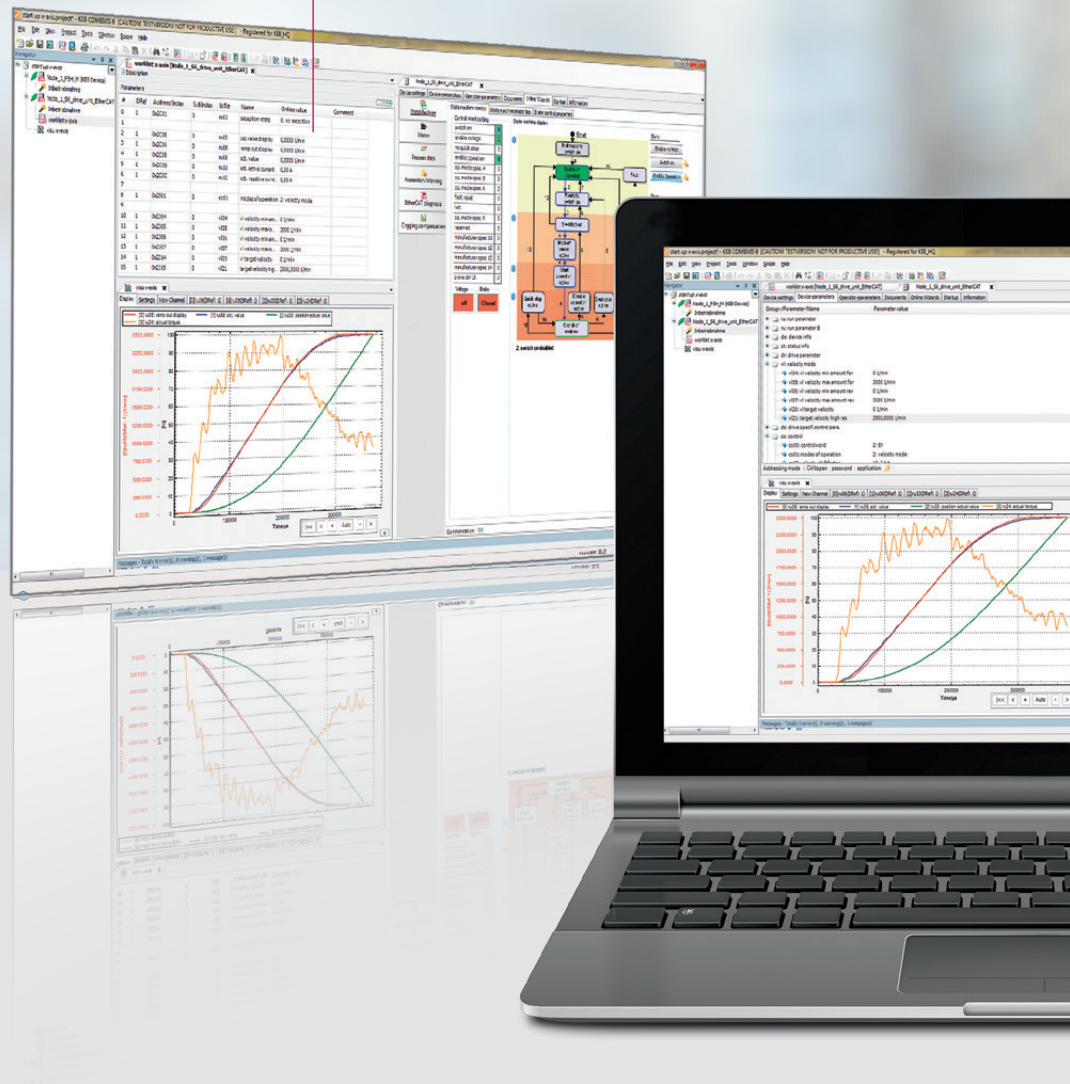

## COMBIVIS studio 6

The intelligent automation suite from KEB combines an assistant-guided component selection, fieldbus configuration, drive parameterisation, IEC 61131-3 project generation and motion control. Throughout the planning and layout phase, implementation of control sequences and multi-axis movement profiles, to start-up and fine tuning, the user is supported by a tool developed by experienced application engineers.

With a foundation built on libraries, devices and template databases, rapid and simple solutions can be generated for a wide range of applications.

**COMMISSIONING ASSISTANT**

- Complete user guidance through the commissioning process
- KEB Motor database, free for extensions
- Anti cogging
- Fieldbus diagnostic and optimisation

**SYSTEM CONFIGURATION AS A COMPONENT OF COMBIVIS**

- Access to KEB product database
- Intuitive gear component selection and system configuration using drag and drop
- Selection assistant with display of compatible components
- Display of all interfaces and connection components
- Material number generator
- Extensive export function for quote list, COMBIVIS Project, Excel ...

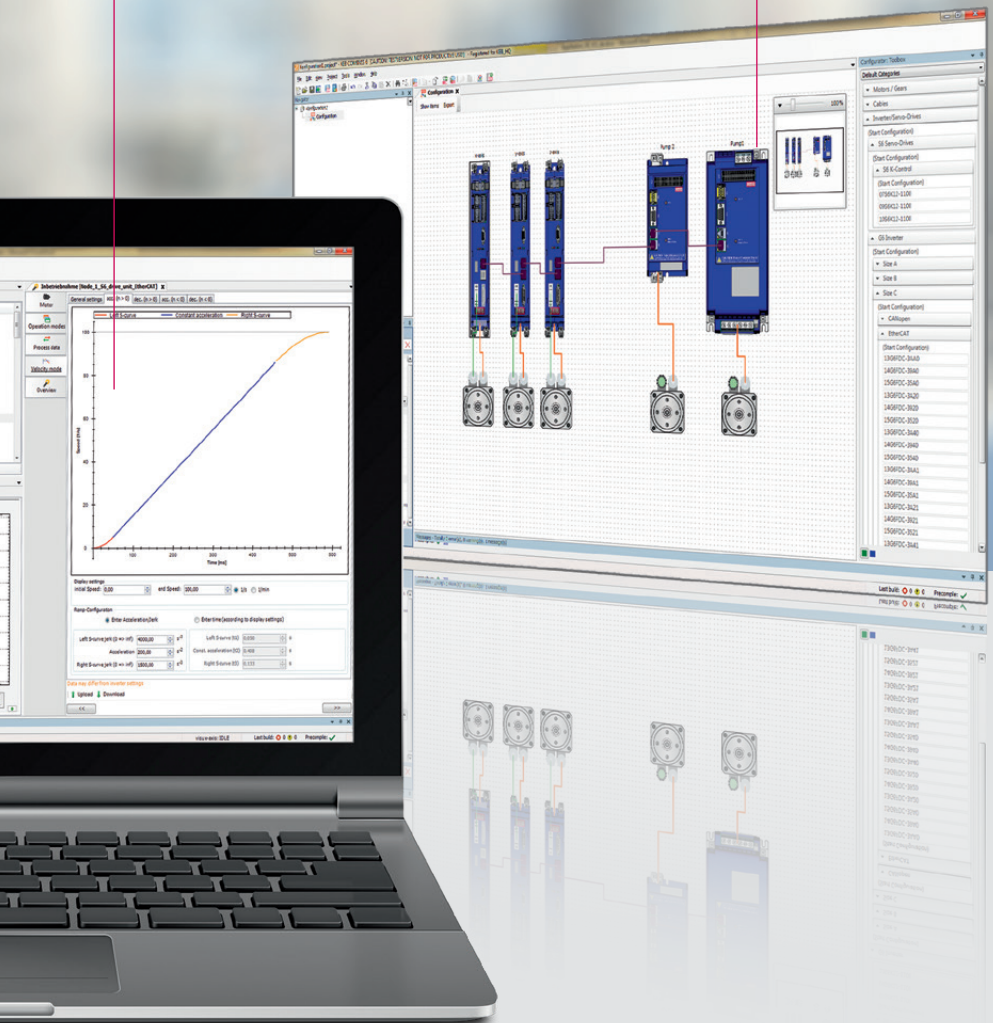

**HIGHLIGHTS**

- IEC 61131-3 Applications development
- Device and library database
- Product configuration
- Start-up and diagnosis assistant
- COMBIVIS studio HMI integration
- Document database

# ACCESSORIES

## STABLE OPERATION IN INDUSTRIAL ENVIRONMENT

An EMC-compliant assembly with efficient control cabinet and suppression system is the basis for safe operation of machinery and equipment. The current and voltage limiting COMBILINE modules are optimally designed to meet the requirements of the COMBIVERT F6 drive controller series and support the use through:



### MAINS EMC FILTERS

Reduce the cable-fed emission to the required limits IEC 61800-3 - C1/C2. Further variants offer low leakage currents or the operation of special mains networks, additionally available as submounted filter for COMBIVERT F6.

### MAINS CHOKES

Reduce the input peak current draw and the mains distortion. By smoothing the input current draw, the lifetime of the drive is enhanced, in particular at constantly high utilization.

### OUTPUT CHOKES AND FILTERS

Reduce the voltage and current stress of the motor winding.

### INPUT / OUTPUT COMBI FILTERS

Space-saving combination, consistently adapted and optimised to the drive controller.

### SINE-WAVE FILTERS

Protect the motor winding from voltage peaks and allow the use of long motor cables.

### HARMONIC FILTERS

Reduce the low frequency mains distortion of B6-rectifier supplied devices. These harmonic filters are the innovative solution to comply to most international standards. The integration to a switch gear layout is as simple as of mains chokes.

### SINE-WAVE EMC FILTERS

Allow operation of motors with long motor cables even without screening.

### HIGH PERFORMANCE FERRITE CORES

Reduces the values of  $du/dt$ 's also in the frequency range of the bearing currents.

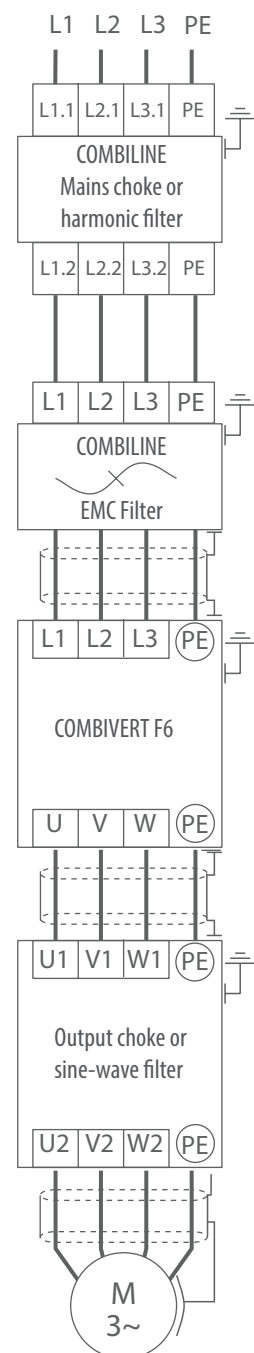



## KEB WORLDWIDE

**Austria** | KEB Automation GmbH

Ritzstraße 8 4614 Marchtrenk Austria  
 Tel: +43 7243 53586-0 Fax: +43 7243 53586-21  
 E-Mail: info@keb.at Internet: www.keb.at

**Benelux** | KEB Automation KG

Dreef 4 – box 4 1703 Dilbeek Belgium  
 Tel: +32 2 447 8580  
 E-Mail: info.benelux@keb.de Internet: www.keb.de

**Czech Republic** | EB Automation GmbH

Videnska 188/119d 61900 Brno Czech Republic  
 Tel: +420 544 212 008  
 E-Mail: info@keb.cz Internet: www.keb.cz

**France** | Société Française KEB SASU

Z.I. de la Croix St. Nicolas 14, rue Gustave Eiffel  
 94510 La Queue en Brie France  
 Tel: +33 149620101 Fax: +33 145767495  
 E-Mail: info@keb.fr Internet: www.keb.fr

**Germany** | Geared Motors

KEB Antriebstechnik GmbH  
 Wildbacher Straße 5 08289 Schneeberg Germany  
 Telefon +49 3772 67-0 Fax +49 3772 67-281  
 E-Mail: info@keb-drive.de Internet: www.keb-drive.de

**Italy** | KEB Italia S.r.l. Unipersonale

Via Newton, 2 20019 Settimo Milanese (Milano) Italy  
 Tel: +39 02 3353531 Fax: +39 02 33500790  
 E-Mail: info@keb.it Internet: www.keb.it

**Japan** | KEB Japan Ltd.

15 - 16, 2 - Chome, Takanawa Minato-ku  
 Tokyo 108 - 0074 Japan  
 Tel: +81 33 445-8515 Fax: +81 33 445-8215  
 E-Mail: info@keb.jp Internet: www.keb.jp

**P. R. China** | KEB Power Transmission Technology (Shanghai) Co. Ltd.

No. 435 QianPu Road Chedun Town Songjiang District  
 201611 Shanghai P. R. China  
 Tel: +86 21 37746688 Fax: +86 21 37746600  
 E-Mail: info@keb.cn Internet: www.keb.cn

**Poland** | KEB Automation KG

Tel: +48 60407727  
 E-Mail: roman.trinczek@keb.de Internet: www.keb.de

**Republic of Korea** | KEB Automation KG

Deoksan-Besttel 1132 ho Sangnam-ro 37  
 Seongsan-gu Changwon-si Gyeongsangnam-do Republic of Korea  
 Tel: +82 55 601 5505 Fax: +82 55 601 5506  
 E-Mail: jaeok.kim@keb.de Internet: www.keb.de

**Russian Federation** | KEB RUS Ltd.

Lesnaya str, house 30 Dzerzhinsky MO  
 140091 Moscow region Russian Federation  
 Tel: +7 495 6320217 Fax: +7 495 6320217  
 E-Mail: info@keb.ru Internet: www.keb.ru

**Spain** | KEB Automation KG

c / Mitjer, Nave 8 - Pol. Ind. LA MASIA  
 08798 Sant Cugat Sesgarrigues (Barcelona) Spain  
 Tel: +34 93 8970268 Fax: +34 93 8992035  
 E-Mail: vb.espana@keb.de Internet: www.keb.de

**Switzerland** | KEB Automation AG

Witzbergstraße 24 8330 Pfaeffikon/ZH Switzerland  
 Tel: +41 43 2886060 Fax: +41 43 2886088  
 E-Mail: info@keb.ch Internet: www.keb.ch

**United Kingdom** | KEB (UK) Ltd.

5 Morris Close Park Farm Industrial Estate  
 Wellingborough, Northants, NN8 6XF United Kingdom  
 Tel: +44 1933 402220 Fax: +44 1933 400724  
 E-Mail: info@keb.co.uk Internet: www.keb.co.uk

**United States** | KEB America, Inc.

5100 Valley Industrial Blvd. South  
 Shakopee, MN 55379 United States  
 Tel: +1 952 2241400 Fax: +1 952 2241499  
 E-Mail: info@kebameric.com Internet: www.kebameric.com



## KEB PARTNERS WORLDWIDE

... [www.keb.de/contact/contact-worldwide](http://www.keb.de/contact/contact-worldwide)



# Automation with Drive

[www.keb.de](http://www.keb.de)

KEB Automation KG Suedstrasse 38 32683 Barntrup Germany Tel. +49 5263 401-0 E-Mail: [info@keb.de](mailto:info@keb.de)

© KEB 0000000-52F6 01/2021 Subject to technical alterations!